

# INSTRUCTION MANUAL



## CS547A Conductivity and Temperature Probe and A547 Interface

Revision: 10/11



Copyright © 1994-2011  
Campbell Scientific, Inc.



# Warranty

---

“PRODUCTS MANUFACTURED BY CAMPBELL SCIENTIFIC, INC. are warranted by Campbell Scientific, Inc. (“Campbell”) to be free from defects in materials and workmanship under normal use and service for twelve (12) months from date of shipment unless otherwise specified on the corresponding Campbell invoice. Batteries, fine-wire thermocouples, desiccant, and other consumables have no warranty. Campbell's obligation under this warranty is limited to repairing or replacing (at Campbell's option) defective products, which shall be the sole and exclusive remedy under this warranty. The customer shall assume all costs of removing, reinstalling, and shipping defective products to Campbell. Campbell will return such products by surface carrier prepaid within the continental United States of America. To all other locations, Campbell will return such products best way CIP (Port of Entry) INCOTERM® 2010, prepaid. This warranty shall not apply to any Campbell products which have been subjected to modification, misuse, neglect, improper service, accidents of nature, or shipping damage. This warranty is in lieu of all other warranties, expressed or implied. The warranty for installation services performed by Campbell such as programming to customer specifications, electrical connections to products manufactured by Campbell, and product specific training, is part of Campbell's product warranty. CAMPBELL EXPRESSLY DISCLAIMS AND EXCLUDES ANY IMPLIED WARRANTIES OF MERCHANTABILITY OR FITNESS FOR A PARTICULAR PURPOSE. Campbell is not liable for any special, indirect, incidental, and/or consequential damages.”

# Assistance

---

Products may not be returned without prior authorization. The following contact information is for US and international customers residing in countries served by Campbell Scientific, Inc. directly. Affiliate companies handle repairs for customers within their territories. Please visit [www.campbellsci.com](http://www.campbellsci.com) to determine which Campbell Scientific company serves your country.

To obtain a Returned Materials Authorization (RMA), contact CAMPBELL SCIENTIFIC, INC., phone (435) 227-2342. After an applications engineer determines the nature of the problem, an RMA number will be issued. Please write this number clearly on the outside of the shipping container. Campbell Scientific's shipping address is:

**CAMPBELL SCIENTIFIC, INC.**

RMA# \_\_\_\_\_  
815 West 1800 North  
Logan, Utah 84321-1784

For all returns, the customer must fill out a "Statement of Product Cleanliness and Decontamination" form and comply with the requirements specified in it. The form is available from our web site at [www.campbellsci.com/repair](http://www.campbellsci.com/repair). A completed form must be either emailed to [repair@campbellsci.com](mailto:repair@campbellsci.com) or faxed to (435) 227-9579. Campbell Scientific is unable to process any returns until we receive this form. If the form is not received within three days of product receipt or is incomplete, the product will be returned to the customer at the customer's expense. Campbell Scientific reserves the right to refuse service on products that were exposed to contaminants that may cause health or safety concerns for our employees.

# CS547A Probe and A547 Interface

## Table of Contents

---

*PDF viewers: These page numbers refer to the printed version of this document. Use the PDF reader bookmarks tab for links to specific sections.*

<b>1. Overview</b> .....	<b>1</b>
1.1 EC Sensor .....	1
1.2 A547 Interface .....	1
<b>2. Specifications</b> .....	<b>2</b>
2.1 CS547A Probe .....	2
2.2 A547 Interface .....	2
2.3 Temperature Sensor .....	3
<b>3. Installation</b> .....	<b>3</b>
3.1 Site Selection .....	3
3.2 Mounting .....	3
<b>4. Wiring</b> .....	<b>3</b>
<b>5. Programming</b> .....	<b>4</b>
5.1 Programming Overview.....	4
5.2 Example Measurement Programs .....	5
5.2.1 CRBasic .....	5
5.2.2 Edlog.....	7
<b>6. Calibration</b> .....	<b>12</b>
6.1 Conversion Factors .....	12
6.2 Typical Ranges .....	12
6.3 Factory Calibration .....	12
6.4 Field Calibration .....	12
6.4.1 CRBasic Calibration Program Example.....	13
6.4.2 Edlog Calibration Program Example .....	13
<b>7. Maintenance</b> .....	<b>15</b>
<b>8. Analysis of Errors</b> .....	<b>15</b>
8.1 EC Measurement Error .....	15
8.2 Temperature Measurement Error.....	17
<b>9. Deriving a Temperature Compensation Coefficient</b> .....	<b>18</b>

**10. Therm107 / P11 Instruction Details ..... 18**

**11. Electrically Noisy Environments .....20**

**12. Long Lead Lengths Temperature .....20**

**13. CS547A Schematic .....21**

**Figures**

1-1. A547 Interface and CS547A Conductivity and Temperature Probe ..... 2

4-1. CS547A wiring diagram for example below ..... 4

8.1-1. Plot of ideal and actual correction between 0 and 0.44 mS cm<sup>-1</sup> ..... 16

8.1-2. Plot of ideal and actual correction between 0.44 and 7.0 mS cm<sup>-1</sup> .... 16

8.2-1. Error produced by polynomial fit to published values ..... 17

13-1. CS547A Conductivity and Temperature circuit diagram ..... 21

13-2. A547 Interface circuit diagram ..... 22

**Tables**

8.2-1. Thermistor Interchangeability Specification Temperature ..... 17

8.2-2. Polynomial Error ..... 17

10-1. Temperature , Resistance, and Datalogger Output ..... 19

10-2. Polynomial Coefficients ..... 19

# ***CS547A Conductivity and Temperature Probe and A547 Interface***

---

## **1. Overview**

The CS547A conductivity and temperature probe, and A547 interface are designed for measuring the electrical conductivity, dissolved solids, and temperature of fresh water with Campbell Scientific dataloggers. This sensor can be used with any CSI logger that can issue a negative excitation. This includes most new CRBasic dataloggers as well as older, Edlog loggers. Exceptions include the CR200-series, the BDR301 and BDR320 loggers which did not have this feature. Use with our AM16/32(B) multiplexer is possible when needing to measure several of these probes on one datalogger.

Electrical conductivity (EC) of a solution is a simple physical property, but measurements can be difficult to interpret. This manual instructs the user how to make EC measurements with the CS547A. Accuracy specifications apply to measurements of EC in water containing KCl, Na<sub>2</sub>SO<sub>4</sub>, NaHCO<sub>3</sub>, and/or NaCl, which are typical calibration compounds, and to EC not yet compensated for temperature effects.

Statements made on methods of temperature compensation or estimating dissolved solids are included to introduce common ways of refining and interpreting data, but are not definitive. Authoritative sources to consult include the [USGS Water-Supply Paper 1473](#), [The pH and Conductivity Handbook](#) published by OMEGA Engineering, physical chemistry texts, and other sources.

### **1.1 EC Sensor**

The EC sensor consists of three stainless steel rings mounted in an epoxy tube as shown in Figure 4-1. Resistance of water in the tube is measured by excitation of the center electrode with positive and negative voltage.

This electrode configuration eliminates the ground looping problems associated with sensors in electrical contact with earth ground.

Temperature is measured with a thermistor in a three wire half bridge configuration.

### **1.2 A547 Interface**

The interface contains the completion resistors and blocking capacitors. The interface should be kept in a non-condensing environment that is maintained within the temperature range of the unit.

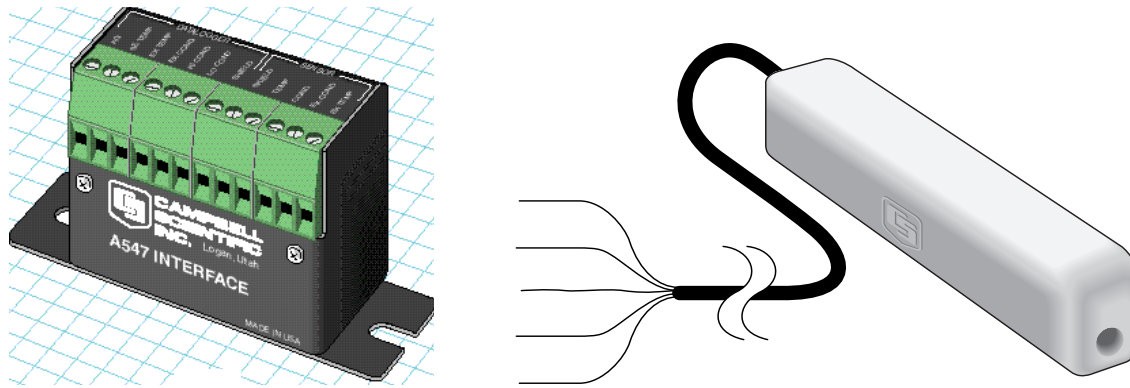

FIGURE 1-1. A547 Interface and CS547A Conductivity and Temperature Probe

## 2. Specifications

### 2.1 CS547A Probe

<b>Construction</b>	The probe housing is epoxy
<b>Size — L x W x H</b>	89 mm (3.5 in.) x 25.4 mm (1 in.) x 19 mm (0.75 in.)
<b>Minimum Pipe ID in which CS547A Fits</b>	28 mm (1.1 in.)
<b>Maximum Cable Length</b>	305 m (1000 ft). The sensor must be ordered with desired length as cable cannot be added to existing probes.
<b>Depth Rating</b>	Maximum 305 m (1000 ft)
<b>pH Range</b>	Solution pH of less than 3.0 or greater than 9.0 may damage the stainless steel housing.
<b>Electrodes</b>	Passivated 316 SS with DC isolation capacitors.
<b>Cell Constant</b>	Individually calibrated. The cell constant ( $K_c$ ) is found on a label near the termination of the cable.
<b>Temp. Range of Use</b>	0° to 50°C.
<b>EC Range</b>	Approx. 0.005 to 7.0 mS cm <sup>-1</sup> .
<b>Accuracy</b>	in KCl and Na <sub>2</sub> SO <sub>4</sub> , NaHCO <sub>3</sub> , and NaCl standards at 25°C: ±5% of reading 0.44 to 7.0 mS cm <sup>-1</sup> . ±10% of reading 0.005 to 0.44 mS cm <sup>-1</sup> .
<b>Weight with 4 ft Cable</b>	120 g (4.2 oz)

### 2.2 A547 Interface

<b>Size</b>	Dimensions: 64 mm (2.5 in.) x 46 mm (1.8 in.) x 23 mm (0.9 in.) Weight: 45 g (2 oz)
<b>Temperature Rating</b>	-15° to +50°C

## 2.3 Temperature Sensor

<b>Thermistor</b>	Betatherm 100K6A1.
<b>Range</b>	0° to 50°C.
<b>Accuracy</b>	Error ±0.4°C (See Section 8.2).

## 3. Installation

---

**CAUTION** Rapid heating and cooling of the probe, such as leaving it in the sun and then submersing it in a cold stream, may cause irreparable damage.

---

### 3.1 Site Selection

The EC sensor measures the EC of water inside the hole running through the sensor, so detection of rapid changes in EC requires that the probe be flushed continuously. This is easy to accommodate in a flowing stream by simply orienting the sensor parallel to the direction of flow. In stilling wells and ground wells, however, diffusion rate of ions limits the response time.

### 3.2 Mounting

The housing and sensor cable are made of water impervious, durable materials. Care should be taken, however, to mount the probe where contact with abrasives and moving objects will be avoided. Strain on cables can be minimized by using a split mesh strain relief sleeve on the cable, which is recommended for cables over 100 ft. The strain relief sleeve is available from Campbell Scientific as part number 7421.

Because the CS547A has a slightly positive buoyancy, we recommend securing the sensor to a fixed or retractable object or selecting the cable weight option.

The A547 is usually mounted in the datalogger enclosure.

## 4. Wiring

---

**WARNING** The voltage excitation channel used for each EC measurement must be separate from the one used for temperature or measurement errors will result. If multiple CS547A/A547s are to be wired to a single logger, each conductivity excitation must be kept on a separate, dedicated VX or EX channel, but you can combine several temperature excitations lines onto a single VX or EX port.

---

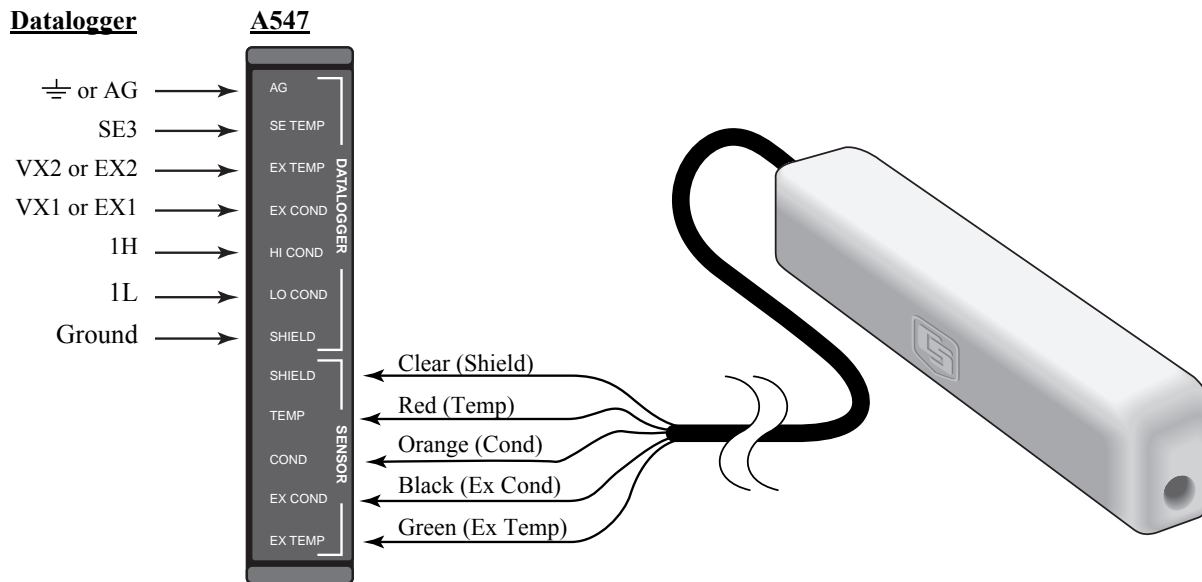

FIGURE 4-1. CS547A wiring diagram for example below

## 5. Programming

All example programs may require modification by the user to fit the specific application's wiring and programming needs. All program examples in this manual are for the CR10(X) or CR1000 and assume that datalogger is wired to the A547 interface as follows: the LO COND lead is connected to 1L, the HI COND to 1H, the EX COND to VX1 or EX1, the EX TEMP to VX2 or EX2, and the SE TEMP to SE3.

### Public Variable Declarations / Input Location Labels

Definitions for the following program:

Rs	Solution resistance
Rp	Resistance of leads/cable and blocking caps
Ct	Solution EC with no temp. correction
Temp_degC	Solution temperature in °C
C25mScm_1	EC corrected for temperature

### 5.1 Programming Overview

Typical datalogger programs to measure the CS547A consist of four parts:

1. Measurement of EC and temperature

EC: Resistance across the electrodes is computed from the results of the **BrFull** (P6) or **BrHalf** (P5) instructions (chosen automatically as part of the autoranging feature) followed by the Bridge Transformation algorithm (P59).

2. Correction of ionization errors in EC measurements

Ionization caused by the excitation of the EC sensor can cause large errors. Campbell Scientific has developed a linear correction for conductivity between 0.005 and 0.44 mS cm<sup>-1</sup>, and a quadratic correction for conductivity between 0.44 and 7.0 mS cm<sup>-1</sup>. Corrections were determined in standard salt solutions containing KCl, Na<sub>2</sub>SO<sub>4</sub>, NaHCO<sub>3</sub>, and NaCl.

3. Correction of temperature errors in EC measurements

The effect of temperature on the sample solution can cause large errors in the EC measurement. A simple method of correcting for this effect is to assume a linear relationship between temperature and EC. This method generally produces values to within 2% to 3% of a measurement made at 25°C.

The best corrections are made when the temperature coefficient is determined at a temperature near field conditions. See Section 9 for details on how to determine the temperature coefficient. If determining the temperature coefficient is not possible, use a value of 2%/°C as a rough estimate.

4. Output processing

Over large ranges, EC is not linear and is best to use the Sample instruction in CRBasic or Instruction 70 in Edlog. In limited ranges, averaging measurements over time may be acceptable; this is accomplished by using the Average instruction in CRBasic or Instruction 71 in Edlog. Convention requires that the temperature at the time of the measurement be reported.

## 5.2 Example Measurement Programs

### 5.2.1 CRBasic

```
'Program name: CS547A.CR1

'////////////////////// DECLARATIONS ////////////////////////////////////////
Public Rcable, Rp, CellConstant, TempCoef
Public Rs, Ct
Public TempDeg_C
Public C25mScm_1
Dim OneOvrRs, Ct100, A, TC_Proces

'////////////////////// OUTPUT SECTION ////////////////////////////////////////
DataTable (ECSample,True,-1)
    DataInterval (0,60,Min,10)
    Sample (1,Ct,FP2)
    Sample (1,TempDeg_C,FP2)
    Sample (1,C25mScm_1,FP2)
EndTable
```

```

"//////////////////// PROGRAM //////////////////////////////////////
BeginProg
  'evaluate and edit each of these 3 user specific values
  Rcable=25          'edit this value to the actual footage of cable on your sensor
  CellConstant=1.50 'edit this value with the Cell Constant (Kc) printed
                    'on the label of each sensor
  TempCoef=2        'see section 9 of the manual for an explanation of how
                    'to more precisely determine the value of this coefficient

  Scan(5,Sec, 3, 0)
    'make a preliminary measurement of resistance to determine best range code
    BRFull(Rs, 1, mV2500, 1, VX1, 1, 2500, True, True, 0, 250, -0.001, 1)
    Rs = 1*Rs/(1.0-Rs)
    'test the initial measurement to then make a more accurate measurement
    Select Case Rs
      Case Is < 1.8
        BRHalf(Rs, 1, mV2500, 2, VX1, 1, 2500, True, 0, 250, 1, 0)
        Rs = (Rs/(1-Rs))

      Case Is < 9.25
        BRFull(Rs, 1, mV2500, 1, VX1, 1, 2500, True, True, 0, 250, -0.001, 1)
        Rs = Rs/(1-Rs)

      Case Is < 280
        BRFull(Rs, 1, mV250, 1, VX1, 1, 2500, True, True, 0, 250, -0.001, 1)
        Rs = Rs/(1-Rs)

    EndSelect

    'Subtract resistance errors (Rp) caused by the blocking capacitors
    '(0.005Kohm and the cable length (0.000032Kohm/ft)

    Rp = -Rcable * (0.000032) - 0.005
    Rs = Rs + Rp

    'EC is then calculated by multiplying the reciprocal of the resistance,
    'which is conductance, by the cell constant

    OneOvrRs = 1 / Rs
    Ct = OneOvrRs * CellConstant

    'the following corrects for errors of ionization in the EC measurement

    If (Ct < 0.474) Then
      Ct = (Ct * 0.95031) - 0.00378
    Else
      Ct = -0.02889 + 0.98614 * Ct + 0.02846 * Ct^2
    EndIf

```

```
'correct errors in the EC measurement due to temperature

Therm107 (TempDeg_C,1,3,Vx2,0,250,1,0)
C25mScm = (Ct * 100)/(((TempDeg_C-25) * TempCoef) + 100)

'end scan loop by calling output table
CallTable ECSample

NextScan
EndProg
```

### 5.2.2 Edlog

```
*Table 1 Program
01: 5           Execution Interval (seconds)

;Make a preliminary measurement of resistance for autoranging.

1: Full Bridge (P6)
  1: 1           Reps
  2: 15          ±2500 mV Fast Range
  3: 1           DIFF Channel
  4: 1           Excite all reps w/Exchan 1
  5: 2500        mV Excitation
  6: 1           Loc [ Rs      ]
  7: -.001       Mult
  8: 1           Offset

2: BR Transform Rf [X/(1-X)] (P59)
  1: 1           Reps
  2: 1           Loc [ Rs      ]
  3: 1           Multiplier (Rf)
;
;Test the initial measurement to make a more accurate measurement.
;

3: CASE (P93)
  1: 1           Case Loc [ Rs      ]

  4: If Case Location < F (P83)
    1: 1.8       F
    2: 30        Then Do

    5: AC Half Bridge (P5)
      1: 1           Reps
      2: 15          ±2500 mV Fast Range
      3: 2           SE Channel
      4: 1           Excite all reps w/Exchan 1
      5: 2500        mV Excitation
      6: 1           Loc [ Rs      ]
      7: 1.0         Mult
      8: 0.0         Offset
```

6: BR Transform  $Rf[X/(1-X)]$  (P59)

- 1: 1           Reps
- 2: 1           Loc [ Rs    ]
- 3: 1           Multiplier (Rf)

7: End (P95)

8: If Case Location < F (P83)

- 1: 9.25        F
- 2: 30          Then Do

9: Full Bridge (P6)

- 1: 1           Reps
- 2: 15          ±2500 mV Fast Range
- 3: 1           DIFF Channel
- 4: 1           Excite all reps w/Exchan 1
- 5: 2500        mV Excitation
- 6: 1           Loc [ Rs    ]
- 7: -.001       Mult
- 8: 1           Offset

10: BR Transform  $Rf[X/(1-X)]$  (P59)

- 1: 1           Reps
- 2: 1           Loc [ Rs    ]
- 3: 1           Multiplier (Rf)

11: End (P95)

12: If Case Location < F (P83)

- 1: 280         F
- 2: 30          Then Do

13: Full Bridge (P6)

- 1: 1           Reps
- 2: 14          ±250 mV Fast Range
- 3: 1           DIFF Channel
- 4: 1           Excite all reps w/Exchan 1
- 5: 2500        mV Excitation
- 6: 1           Loc [ Rs    ]
- 7: -.001       Mult
- 8: 1           Offset

14: BR Transform  $Rf[X/(1-X)]$  (P59)

- 1: 1           Reps
- 2: 1           Loc [ Rs    ]
- 3: 1           Multiplier (Rf)

15: End (P95)

16: End (P95)

```

;
;Subtract resistance errors (Rp) caused by the blocking capacitors
;(0.005Kohm) and the cable length (0.000032kohm/ft). Enter cable lead
;length in nnn below.
;

```

```

17: Z=F (P30)
1: nnn      F                      Enter cable length in feet.
2: 00      Exponent of 10
3: 5       Z Loc [ Rp    ]

```

```

18: Z=X*F (P37)
1: 5       X Loc [ Rp    ]
2: .00032  F
3: 5       Z Loc [ Rp    ]

```

```

19: Z=X*F (P37)
1: 5       X Loc [ Rp    ]
2: -.1     F
3: 5       Z Loc [ Rp    ]

```

```

20: Z=X+F (P34)
1: 5       X Loc [ Rp    ]
2: -.005   F
3: 5       Z Loc [ Rp    ]

```

```

21: Z=X+Y (P33)
1: 1       X Loc [ Rs    ]
2: 5       Y Loc [ Rp    ]
3: 1       Z Loc [ Rs    ]

```

```

;EC is then calculated by multiplying the reciprocal of resistance,
;which is conductance, by the cell constant.

```

**NOTE:** The cell constant (Kc) is printed on the label of each sensor or it can be calculated (see Section 6.4). It is entered in place of nnn below.

```

22: Z=1/X (P42)
1: 1       X Loc [ Rs    ]
2: 2       Z Loc [ one_ovrRs ]

```

```

23: Z=X*F (P37)
1: 2       X Loc [ one_ovrRs ]
2: nnn     F                      Enter cell constant.
3: 3       Z Loc [ Ct    ]

```

```

;
;The following program set corrects for errors of ionization in the EC
;measurement.
;

```

```

24: IF (X<=>F) (P89)
1: 3      X Loc [ Ct    ]
2: 4      <
3: .474   F
4: 30     Then Do

25: Z=X*F (P37)
1: 3      X Loc [ Ct    ]
2: .95031 F
3: 3      Z Loc [ Ct    ]

26: Z=X+F (P34)
1: 3      X Loc [ Ct    ]
2: -.00378 F
3: 3      Z Loc [ Ct    ]

27: Else (P94)

28: Polynomial (P55)
1: 1      Reps
2: 3      X Loc [ Ct    ]
3: 3      F(X) Loc [ Ct    ]
4: -.02889 C0
5: .98614 C1
6: .02846 C2
7: .000000 C3
8: .000000 C4
9: .000000 C5

29: End (P95)

;This next program set will correct errors in the EC measurement resulting
;from temperature differences.
;

30: Temp (107) (P11)
1: 1      Reps
2: 3      SE Channel
3: 2      Excite all reps w/E2
4: 4      Loc [ Temp_degC ]
5: 1.0    Mult
6: 0.0    Offset

31: Z=X+F (P34)
1: 4      X Loc [ Temp_degC ]
2: -25    F
3: 6      Z Loc [ A      ]

32: Z=X*F (P37)
1: 3      X Loc [ Ct    ]
2: 100    F
3: 7      Z Loc [ Ct100 ]
    
```

```

33: Z=X*F (P37)
   1: 6          X Loc [ A      ]
   2: nnn        F
   3: 8Z Loc [ TC_Proces ]
                                     Enter TC (%/°C) to correct cond. reading.

34: Z=X+F (P34)
   1: 8          X Loc [ TC_Proces ]
   2: 100        F
   3: 8          Z Loc [ TC_Proces ]

35: Z=X/Y (P38)
   1: 7          X Loc [ Ct100  ]
   2: 8          Y Loc [ TC_Proces ]
   3: 9          Z Loc [ C25mScm_1 ]
                                     EC corrected for temperature.

;Output processing, convention states that the temperature be reported
;with the EC measurement.
;

36: Do (P86)
   1: 10         Set Output Flag High (Flag 0)

37: Sample (P70)
   1: 1          Reps
   2: 3          Loc [ Ct      ]

38: Sample (P70)
   1: 1          Reps
   2: 4          Loc [ Temp_degC ]

39: Sample (P70)
   1: 1          Reps
   2: 9          Loc [ C25mScm_1 ]

*Table 2 Program
  02: 0.0        Execution Interval (seconds)

*Table 3 Subroutines

End Program

```

## 6. Calibration

### 6.1 Conversion Factors

1 S (Siemens) = 1 mho = 1/ohm

Although  $\text{mS}\cdot\text{cm}^{-1}$  and  $\mu\text{S}\cdot\text{cm}^{-1}$  are the commonly used units of EC, the SI base unit is  $\text{S}\cdot\text{m}^{-1}$ . The result of the example programs is  $\text{mS}\cdot\text{cm}^{-1}$

EC measurements can be used to estimate dissolved solids. For high accuracy, calibration to the specific stream is required. However, for rough estimates, values between 550 and 750  $\text{mg}\cdot\text{l}^{-1}$  /  $\text{mS}\cdot\text{cm}^{-1}$  are typical with the higher values generally being associated with waters high in sulfate concentration (USGS Water-Supply Paper #1473, p. 99). A common practice is to multiply the EC in  $\text{mS}\cdot\text{cm}^{-1}$  by 500 to produce ppm or  $\text{mg}\cdot\text{l}^{-1}$ .

### 6.2 Typical Ranges

Single distilled water will have an EC of at least  $0.001 \text{ mS}\cdot\text{cm}^{-1}$ . ECs of melted snow usually range from  $0.002$  to  $0.042 \text{ mS}\cdot\text{cm}^{-1}$ . ECs of stream water usually range from  $0.05$  to  $50.0 \text{ mS}\cdot\text{cm}^{-1}$ , the higher value being close to the EC of sea water (USGS Water-Supply Paper 1473, p. 102).

### 6.3 Factory Calibration

The CS547A is shipped with a cell constant calibrated in a 0.01 molal KCl solution at  $25.0^\circ\text{C} \pm 0.05^\circ\text{C}$ . The solution has an EC of  $1.408 \text{ mS}\cdot\text{cm}^{-1}$ .

### 6.4 Field Calibration

The cell constant is a dimensional number expressed in units of  $\text{cm}^{-1}$ . The unit  $\text{cm}^{-1}$  is slightly easier to understand when expressed as  $\text{cm}\cdot\text{cm}^{-2}$ . Because it is dimensional, the cell constant as determined at any one standard, will change only if the physical dimensions inside the CS547A probe change. Error due to thermal expansion and contraction is negligible. Corrosion and abrasion, however, have the potential of causing significant errors.

A field calibration of the CS547A cell constant can be accomplished as follows:

1. Make a 0.01 molal KCL solution by dissolving 0.7456 g of reagent grade KCl in 1000 g of distilled water, or purchase a calibration solution.
2. Clean the probe thoroughly with the black nylon brush shipped with the CS547A and a small amount of soapy water. Rinse thoroughly with distilled water, dry thoroughly, and place in the KCl solution.
3. Connect the CS547A and A547 or probe and interface to the datalogger using the wiring described in Section 4. Program the datalogger to make the field calibration (see Section 6.4.1 if you have CRBasic datalogger or Section 6.4.2 if you have an Edlog datalogger).

The calibration solution temperature must be between 1°C and 35°C; a polynomial is used to correct for temperature errors within this range. The solution constant of 1.408 mS cm<sup>-1</sup> (for prepared solution mentioned above), is valid only for a 0.01 molal KCl solution.

#### 6.4.1 CRBasic Calibration Program Example

```
'CR1000 Datalogger
'Field Calibration program to determine new Cell Constant (Kc) for CS547A conductivity probe
Public Rs, Rp, T
Dim T_25, f_of_T
Public Conductivity, Kc
Const CalSolution = 1.408           'for 0.01 molal KCL solution
'Data Table not required for Field Calibration – monitor “Kc” in Public table
'Main Program
BeginProg
'edit cable length (Rp) to reflect footage of actual lead length
  Rp = 25 'feet
  Scan (10,Sec,0,0)
    BrHalf(Rs, 1, mV2500, 2, VX1, 1, 2500, True, 0, 250, 1, 0)
    Rs =(Rs/(1-Rs))
    'correct for resistance of cabling
    Rs = Rs + (((Rp*.00032)* -0.1) - 0.005)
    'compensate for temperature effects
    Therm107 (T,1,3,Vx2,0,_60Hz,1.0,0)
    T_25 = (T-25) * 0.01
    f_of_T = 0.99124 - (1.8817*T_25) + (3.4789*T_25^2) - (3.51*T_25^3) - (1.2*T_25^4)
      - (43*T_25^5)
    Conductivity = (1/f_of_T)*CalSolution
    Kc = Conductivity * Rs
  NextScan
EndProg
```

#### 6.4.2 Edlog Calibration Program Example

In step 11, the polynomial instruction (P58) is used to correct for temperature errors within the 1°C to 35°C range. In step 13, the solution constant of 1.408 mS cm<sup>-1</sup> is entered by using P37. Location 8 [Kc(cm<sup>-1</sup>)], generated by Step 14 will contain the resultant cell constant.

```
1: AC Half Bridge (P5)
  1: 1      Rep
  2: 15     2500 mV fast Range (5000 mV fast for 21X)
  3: 2      IN Chan
  4: 1      Excite all reps w/EXchan 1
  5: 2500   mV Excitation (5000 mV for 21X)
  6: 1      Loc [Rs  ]
  7: 1      Mult
  8: 0      Offset
```

2: BR Transform $Rf[X/(1-X)]$ (P59)		
1:	1	Rep
2:	1	Loc [Rs ]
3:	1	Multiplier (Rf)
3: Z=F (P30)		
1:	nmn	F <i>Enter Cable Length in Feet</i>
2:	00	Exponent of 10
3:	5	Loc [Rp ]
4: Z=X*F (P37)		
1:	5	Loc [Rp ]
2:	.00032	F
3:	5	Loc [Rp ]
5: Z=X*F (P37)		
1:	5	Loc [Rp ]
2:	-.1	F
3:	5	Loc [Rp ]
6: Z=X+F (P34)		
1:	5	Loc [Rp ]
2:	-.005	
3:	5	Loc [Rp ]
7: Z=X+Y (P33)		
1:	1	X Loc [Rs ]
2:	5	Y Loc [Rp ]
3:	1	Z Loc [Rs ]
8: Temp 107 Probe (P11)		
1:	1	Rep
2:	3	IN Chan
3:	2	Excite all reps w/EXchan 2
4:	2	Loc [t ]
5:	1	Mult
6:	0	Offset
9: Z=X+F (P34)		
1:	2	X Loc [t ]
2:	-25	F
3:	3	Z Loc [T25_01]
10: Z=X*F (P37)		
1:	3	X Loc [T25_01]
2:	.01	F
3:	3	Z Loc [T25_01]

```

11: Polynomial (P55)
  1: 1      Rep
  2: 3      X Loc [T25_01]
  3: 4      F(X) Loc [f_of_T  ]
  4: .99124 C0
  5: -1.8817 C1
  6: 3.4789 C2
  7: -3.51  C3
  8: -1.2   C4
  9: -43    C5

12: Z=1/X (P42)
  1: 4      X Loc [f_of_T  ]
  2: 6      Z Loc [one_ovrfT  ]

13: Z=X*F (P37)
  1: 6      X Loc [one_ovrfT  ]
  2: 1.408  F
  3: 7      Z Loc [Conductiv]
                                     EC of calibration solution

14: Z=X*Y (P36)
  1: 7      X Loc [Conductiv]
  2: 1      Y Loc [Rs  ]
  3: 8      Z Loc [Kc  ]

End

```

## 7. Maintenance

Routine maintenance includes thoroughly cleaning the orifice of the CS547A probe with the black nylon brush provided and a little soapy water. Rinse thoroughly.

## 8. Analysis of Errors

### 8.1 EC Measurement Error

1. Bridge Measurement Error: < 1.0%
2. Calibration Error:  
bridge measurement: < 0.5%  
calibration solution: < 1.0%
3. Ionization Error of KCl and Na<sup>+</sup> Solutions After Correction:  
< 2.0%, 0.45 to 7.0 mS cm<sup>-1</sup>  
< 8.0%, 0.005 to 0.45 mS cm<sup>-1</sup>

**Correction of Ionization Errors:** Figures 8.1-1 and 8.1-2 show the amount of correction applied by the example program to compensate for ionization effects on the measurements. Also shown is an ideal correction. Factors were

derived by measuring the standard solutions described in Section 2.2 with values of 0.0234, 0.07, 0.4471, 0.7, 1.413, 2.070, 3.920, and 7.0 mS cm<sup>-1</sup>.

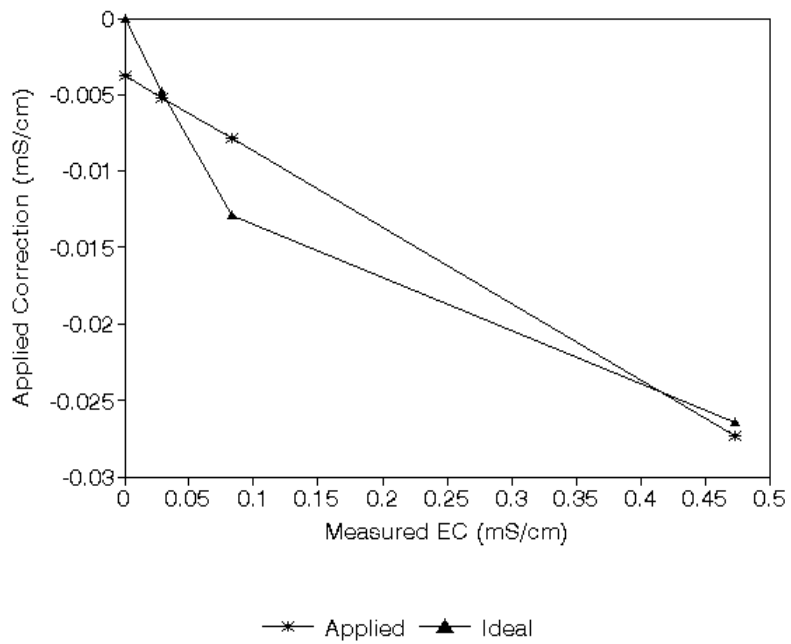

FIGURE 8.1-1. Plot of ideal and actual correction between 0 and 0.44 mS cm<sup>-1</sup>

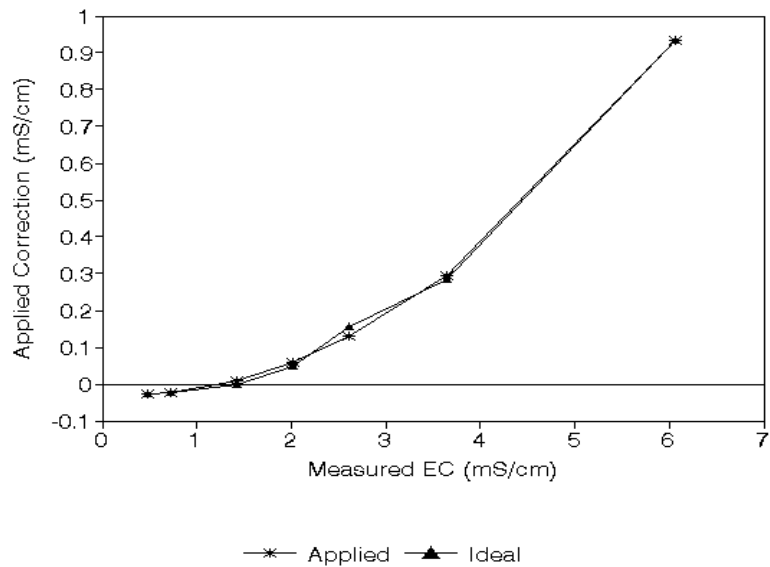

FIGURE 8.1-2. Plot of ideal and actual correction between 0.44 and 7.0 mS cm<sup>-1</sup>

## 8.2 Temperature Measurement Error

The overall probe accuracy is a combination of the thermistor's interchangeability specification, the precision of the bridge resistors, and the polynomial error. In a "worst case" all errors add to an accuracy of  $\pm 0.4^{\circ}\text{C}$  over the range of  $-24^{\circ}$  to  $48^{\circ}\text{C}$  and  $\pm 0.9^{\circ}\text{C}$  over the range of  $-38^{\circ}\text{C}$  to  $53^{\circ}\text{C}$ . The major error component is the interchangeability specification of the thermistor, tabulated in Table 8.2-1. For the range of  $0^{\circ}$  to  $50^{\circ}\text{C}$  the interchangeability error is predominantly offset and can be determined with a single point calibration. Compensation can then be done with an offset entered in the measurement instruction. The bridge resistors are 0.1% tolerance with a 10 ppm temperature coefficient. Polynomial errors are tabulated in Table 8.2-2 and plotted in Figure 8.2-1.

TABLE 8.2-1. Thermistor Interchangeability Specification Temperature	
Temperature ( $^{\circ}\text{C}$ )	Tolerance ( $\pm^{\circ}\text{C}$ )
-40	0.40
-30	0.40
-20	0.32
-10	0.25
0 to +50	0.20

TABLE 8.2-2. Polynomial Error	
-40 to +56	$<\pm 1.0^{\circ}\text{C}$
-38 to +53	$<\pm 0.5^{\circ}\text{C}$
-24 to +48	$<\pm 0.1^{\circ}\text{C}$

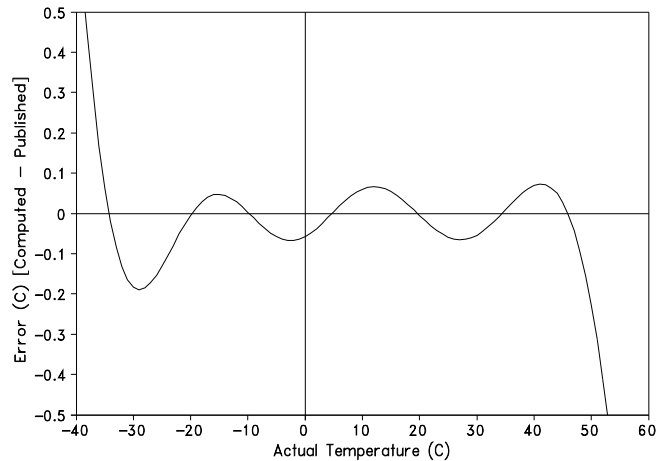

FIGURE 8.2-1. Error produced by polynomial fit to published values

## 9. Deriving a Temperature Compensation Coefficient

1. Place the CS547A in a sample of the solution to be measured. Bring the sample and the probe to 25°C.
2. Enter the example program from Section 5.2 in the datalogger and record  $C_1$  at 25°C from Location 3. This number will be  $C_{25}$  in the formula in Step 4.
3. Bring the solution and the probe to a temperature (t) near the temperature at which field measurements will be made. This temperature will be t (in °C) in the formula. Record  $C_1$  at the new temperature from Location 3. This number will be C in the formula in Step 4.
4. Calculate the temperature coefficient (TC) using the following formula.

$$TC = 100 * \frac{(C - C_{25})}{(t - 25) * C_{25}} = \% / ^\circ C$$

Enter TC in the appropriate location (*nnn*) as shown in the program segment in Section 5.2 .

## 10. Therm107 / P11 Instruction Details

Understanding the details in this section is not necessary for general operation of the CS547A probe with CSI's dataloggers.

The **Therm107** instruction (or P11 in Edlog) outputs a precise 2 VAC excitation (4 V with the 21X) and measures the voltage drop due to the sensor resistance. The thermistor resistance changes with temperature. The instruction calculates the ratio of voltage measured to excitation voltage ( $V_s/V_x$ ) which is related to resistance, as shown below:

$$V_s/V_x = 1000 / (R_s + 249000 + 1000)$$

where  $R_s$  is the resistance of the thermistor.

See the measurement section of the datalogger manual for more information on bridge measurements.

Temperature is calculated using a fifth order polynomial equation correlating  $V_s/V_x$  with temperature. The polynomial coefficients are given in Table 10-2. The polynomial input is  $(V_s/V_x) * 800$ . Resistance and datalogger output at several temperatures are shown in Table 10-1.

Temperature (°C)	Resistance (Ω)	Temperature (°C)
0.00	351017	-0.06
2.00	315288	1.96
4.00	283558	3.99
6.00	255337	6.02
8.00	230210	8.04
10.00	207807	10.06
12.00	187803	12.07
14.00	169924	14.06
16.00	153923	16.05
18.00	139588	18.02
20.00	126729	19.99
22.00	115179	21.97
24.00	104796	23.95
26.00	95449	25.94
28.00	87026	27.93
30.00	79428	29.95
32.00	72567	31.97
34.00	66365	33.99
36.00	60752	36.02
38.00	55668	38.05
40.00	51058	40.07
42.00	46873	42.07
44.00	43071	44.05
46.00	39613	46.00
48.00	36465	47.91
50.00	33598	49.77
52.00	30983	51.59
54.00	28595	53.35
56.00	26413	55.05
58.00	24419	56.70
60.00	22593	58.28

COEFFICIENT	VALUE
C0	-53.4601
C1	9.08067
C2	-8.32569 x 10 <sup>-01</sup>
C3	5.22829 x 10 <sup>-02</sup>
C4	-1.67234 x 10 <sup>-03</sup>
C5	2.21098 x 10 <sup>-05</sup>

## 11. Electrically Noisy Environments

AC power lines can be the source of electrical noise. If the datalogger is in an electronically noisy environment, the 107 temperature measurement should be measured with longer integration periods than 250 $\mu$ Sec. For CRBasic loggers, the **Therm107** Integration parameter has options for 60 Hz rejection that impose a long 3mSec integration. Sixty and 50 Hz rejection is also available as an option in the Excitation Channel parameter of Instruction 11 for the CR10X, CR510, and CR23X dataloggers. For the CR10, CR21X and CR7, the 107 should be measured with the AC half bridge (Instruction 5).

### Example 11-1, CR1000 measurement instruction with 60 Hz rejection:

```
Therm107(TempDeg_C,1,3,2,0,_60Hz,1.0,0.0)
```

### Example 11-2. Sample CR10(X) Instructions Using AC Half Bridge

1: AC Half Bridge (P5)	
1: 1	Rep
2: 22**	7.5 mV 60 Hz rejection Range
3: 3*	IN Chan
4: 2*	Excite all reps w/EXchan 2
5: 2000**	mV Excitation
6: 11*	Loc [ Air_Temp ]
7: 800	Mult
8: 0	Offset
2: Polynomial (P55)	
1: 1	Rep
2: 11*	X Loc [ Air_Temp ]
3: 11*	F(X) Loc [ Air_Temp ]
4: -53.46	C0
5: 90.807	C1
6: -83.257	C2
7: 52.283	C3
8: -16.723	C4
9: 2.211	C5
* Proper entries will vary with program and datalogger channel and input location assignments.	
** On the 21X and CR7 use the 15 mV input range and 4000 mV excitation.	

## 12. Long Lead Lengths Temperature

If the CS547A has lead lengths of more than 300 feet, use the DC Half Bridge instruction (Instruction 4) with a 2 millisecond delay to measure temperature. The delay provides a longer settling time before the measurement is made. Do not use the CS547A with long lead lengths in an electrically noisy environment.

For all CRBasic loggers, as well as CR10X, CR510 and CR23X that have 60 and 50 Hz integration options, this forces a 3 mSec settling time, which accommodates long lead lengths. Longer settling times can be entered into the Settling Time parameter.

**Example 12-1. CR1000 measurement instruction with 20 mSec (20000 uSec) delay:**

Therm107(TempDeg\_C,1,3,2,20000,\_60Hz,1.0,0.0)

**Example 12-2. Sample Program CR10 Using DC Half Bridge with Delay**

```

1: Excite, Delay, Volt(SE) (P4)
  1: 1      Rep
  2: 2**    7.5 mV slow range
  3: 3*     IN Chan
  4: 2*     Excite all reps w/EXchan 2
  5: 2      Delay (units .01sec)
  6: 2000** mV Excitation
  7: 11*    Loc [ Temp_C ]
  8: .4***  Mult
  9: 0      Offset

2: Polynomial (P55)
  1: 1      Rep
  2: 11*    X Loc Temp_C
  3: 11*    F(X) Loc [ Temp_C ]
  4: -53.46 C0
  5: 90.807 C1
  6: -83.257 C2
  7: 52.283 C3
  8: -16.723 C4
  9: 2.211 C5

*   Proper entries will vary with program and datalogger channel and input location assignments.
**  On the 21X and CR7 use the 15 mV input range and 4000 mV excitation.
*** Use a multiplier of 0.2 with a 21X and CR7.
    
```

### 13. CS547A Schematic

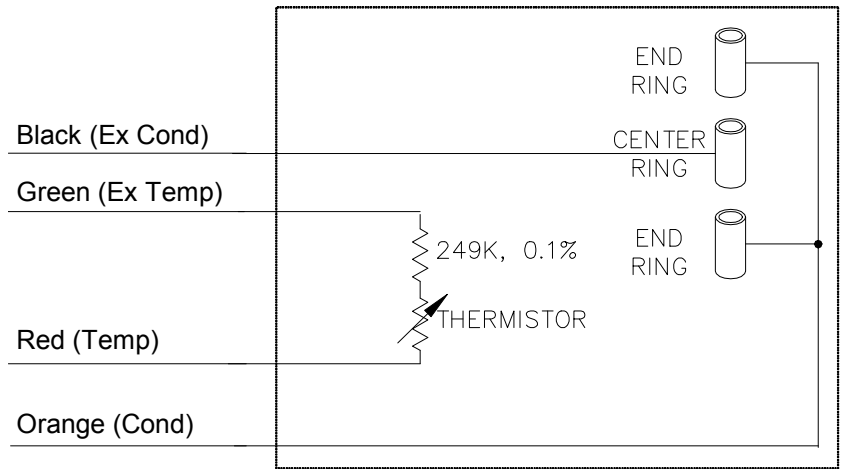

FIGURE 13-1. CS547A Conductivity and Temperature circuit diagram

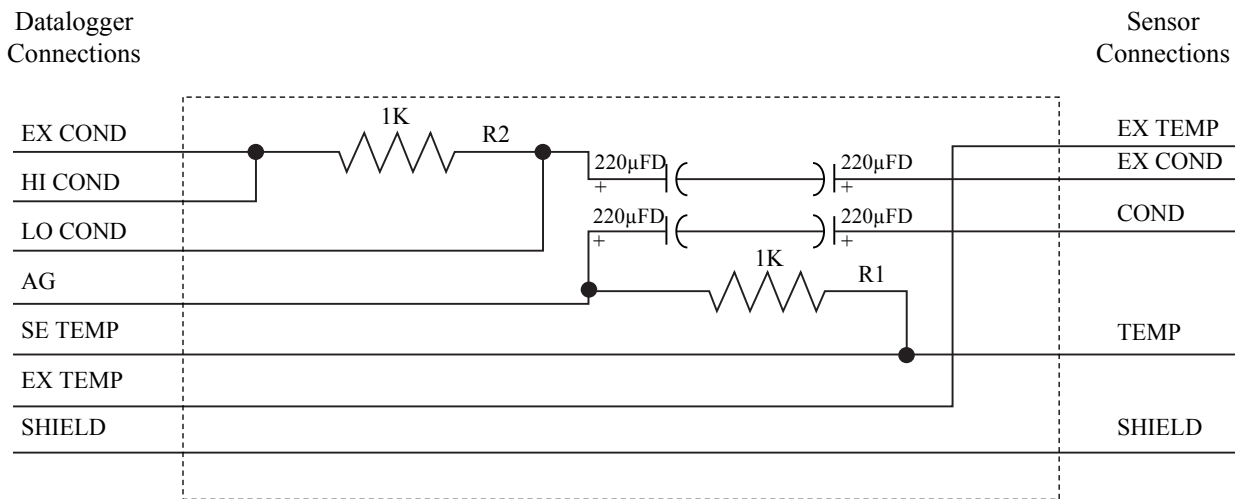

FIGURE 13-2. A547 Interface circuit diagram



## **Campbell Scientific Companies**

---

**Campbell Scientific, Inc. (CSI)**

815 West 1800 North  
Logan, Utah 84321  
UNITED STATES  
www.campbellsci.com • info@campbellsci.com

**Campbell Scientific Africa Pty. Ltd. (CSAf)**

PO Box 2450  
Somerset West 7129  
SOUTH AFRICA  
www.csafrica.co.za • cleroux@csafrica.co.za

**Campbell Scientific Australia Pty. Ltd. (CSA)**

PO Box 444  
Thuringowa Central  
QLD 4812 AUSTRALIA  
www.campbellsci.com.au • info@campbellsci.com.au

**Campbell Scientific do Brazil Ltda. (CSB)**

Rua Luisa Crapsi Orsi, 15 Butantã  
CEP: 005543-000 São Paulo SP BRAZIL  
www.campbellsci.com.br • suporte@campbellsci.com.br

**Campbell Scientific Canada Corp. (CSC)**

11564 - 149th Street NW  
Edmonton, Alberta T5M 1W7  
CANADA  
www.campbellsci.ca • dataloggers@campbellsci.ca

**Campbell Scientific Centro Caribe S.A. (CSCC)**

300 N Cementerio, Edificio Breller  
Santo Domingo, Heredia 40305  
COSTA RICA  
www.campbellsci.cc • info@campbellsci.cc

**Campbell Scientific Ltd. (CSL)**

Campbell Park  
80 Hathern Road  
Shepshed, Loughborough LE12 9GX  
UNITED KINGDOM  
www.campbellsci.co.uk • sales@campbellsci.co.uk

**Campbell Scientific Ltd. (France)**

3 Avenue de la Division Leclerc  
92160 ANTONY  
FRANCE  
www.campbellsci.fr • info@campbellsci.fr

**Campbell Scientific Spain, S. L.**

Avda. Pompeu Fabra 7-9, local 1  
08024 Barcelona  
SPAIN  
www.campbellsci.es • info@campbellsci.es

*Please visit [www.campbellsci.com](http://www.campbellsci.com) to obtain contact information for your local US or International representative.*