



# RV50(X)

Sierra Wireless AirLink®  
4G LTE Cellular Modem



# Table of contents

---

<b>1. Introduction</b> .....	<b>1</b>
<b>2. Precautions</b> .....	<b>2</b>
<b>3. Initial inspection</b> .....	<b>3</b>
<b>4. Pre-installation</b> .....	<b>4</b>
4.1 Establish cellular service .....	4
4.1.1 Campbell Scientific cellular data service .....	4
4.1.2 Other service providers .....	4
4.2 Install the SIM card .....	5
4.3 Konect PakBus Router setup .....	6
4.3.1 Get started .....	6
4.3.2 Set up Konect PakBus Router .....	7
<b>5. QuickStart</b> .....	<b>9</b>
5.1 Modules using Konect PakBus Router (private dynamic IP) .....	11
5.1.1 Configure RV50(X) .....	11
5.1.2 Enabling PPP mode .....	14
5.1.3 Set up LoggerNet .....	16
5.1.4 Test the connection .....	19
5.2 Modules using a public static IP .....	19
5.2.1 Configure RV50(X) .....	19
5.2.2 Additional security (optional but recommended) .....	22
5.2.3 Enabling PPP mode .....	23
5.2.4 Set up LoggerNet .....	24
5.2.5 Test the connection .....	27
<b>6. Specifications</b> .....	<b>27</b>
<b>7. Installation</b> .....	<b>29</b>
7.1 Base station requirements .....	29
7.2 Data logger site equipment .....	29
7.2.1 RV50(X) mounting kit .....	32
7.2.1.1 Mounting the RV50(X) flat on the backplate .....	32
7.2.1.2 Mounting the RV50(X) on edge to the backplate .....	32

7.3 Wiring and connections .....	33
7.3.1 Module communications connections .....	33
7.3.2 Module power connections .....	34
7.3.3 Antenna connections .....	35
7.4 Hardware and software setup .....	36
<b>8. Operation and maintenance .....</b>	<b>37</b>
8.1 Ports .....	37
8.2 LED indicator lights .....	37
8.3 Signal strength and quality .....	39
8.3.1 Signal strength .....	40
8.3.2 Signal quality .....	40
8.4 Rebooting the RV50(X) .....	41
8.5 Reset the RV50(X) to factory default settings .....	41
8.6 Recovery mode .....	41
<b>9. Attributions .....</b>	<b>42</b>
<b>Appendix A. ACESManager and template files .....</b>	<b>43</b>
A.1 Additional security (optional but recommended) .....	46
<b>Appendix B. Controlling power to the RV50(X) .....</b>	<b>48</b>
<b>Appendix C. Using the RV50(X) Ethernet port .....</b>	<b>50</b>
<b>Appendix D. Verizon Wireless and AT&amp;T .....</b>	<b>52</b>
D.1 Verizon Wireless .....	52
D.2 AT&T .....	53
<b>Appendix E. Regulatory information .....</b>	<b>54</b>
E.1 Important information for North American users .....	54
E.2 RF exposure .....	54
E.3 EU .....	55
E.4 Declaration of conformity .....	55
E.5 RoHS compliance .....	56

# 1. Introduction

---

This manual provides information for interfacing the RV50(X) Sierra Wireless AirLink® 4G LTE Cellular Modem to Campbell Scientific dataloggers.

The RV50(X) digital cellular modem is manufactured by Sierra Wireless® and supports network operator switching based on the SIM(s) for use on GSM (Global System for Mobile Communications) and CDMA (Code Division Multiple Access) networks. The modem is accessed through the Internet using TCP/IP communications protocol.

Use of the RV50(X) requires a VerizonLTE or AT&T® HSPA+/LTE business account or an equivalent account from Campbell Scientific or another service provider. For more information, see [Establish cellular service](#) (p. 4)

## NOTE:

The RV50 also supports Verizon® CDMA/1xRTT/EVDO and AT&T® HSPA+/LTE accounts.

For additional information on the RV50(X) module, see the Support section of the Sierra Wireless website.

Before using the RV50(X), please study:

- [Safety](#) (p. 59)
- [Initial inspection](#) (p. 3)
- [Pre-installation](#) (p. 4)
- [QuickStart](#) (p. 9)

The RV50(X) module may be configured in one of two ways, depending on the communications type and needs of the user. **ACEmanager**, a web based configuration tool is hosted by the RV50 (X). It can be accessed using a web browser over the cellular WAN or locally over Ethernet. A number of templates will be provided for download to make most configurations very simple once connected to **ACEmanager**.

For many applications, the preferred module setup is Point-to-Point Protocol (PPP) mode. In this mode, the module simply passes IP communications directly to the data logger. This enables features such as FTP, HTTP, and emailing. [QuickStart](#) (p. 9) describes setting up the module for PPP mode. See the [EmailRelay\(\) paper](#) and [Blog article with example programs](#) for more information on emailing.

Alternatively, for applications that just need a connection for data collection and data logger maintenance or monitoring, setup as a serial server is sufficient. In this mode, the module

receives IP communications over the cellular network and converts those to serial (RS-232) communications to pass on to the data logger. From the data logger perspective, this is no different than a serial cable connecting it to a computer. For information on configuring the RV50(X) in serial-server mode, see [ACEManager and template files](#) (p. 43)

## 2. Precautions

---

READ AND UNDERSTAND the [Safety](#) (p. 59) section at the front of this manual.

### CAUTION:

This device uses considerably more power than the data logger, see [Specifications](#) (p. 27). It may require a larger power supply, switching power with the data logger, or a combination of these to ensure the battery is not drained. See [Controlling power to the RV50\(X\)](#) (p. 48) for program examples of using switched 12V to control power to the RV50(X).

We strongly recommend changing the default RV50(X) *ACEManager* password to prevent unauthorized access and the potential of malware infection. The password can be changed from the *ACEManager Admin* tab.

### WARNING:

Failure to set a strong password in the RV50(X) may result in misuse of the modem by malware or hackers. Significant data overage charges may apply.

To prevent unwanted data usage when using a public static IP, consider doing the following:

- Limit open ports – Limit the number of configured ports that the RV50(X) is listening on. Open ports increase the chance of unwanted exploitation resulting in higher data usage and possible equipment misuse.

The *ACEManager* template provided by Campbell Scientific limits these ports for you. Only the ports needed for communications with your data logger are opened. It is important to load the template prior to adding or deleting any additional ports.

- Set Trusted IPs – The RV50(X) Trusted IP list limits devices that the RV50(X) will respond to. This requires entering the public IP address of each computer that will connect with or through the RV50(X). Each computer must have an unchanging public IP address set in *ACEManager* on the **Security** tab in the **Trusted IPs - Inbound (Friends)** field.

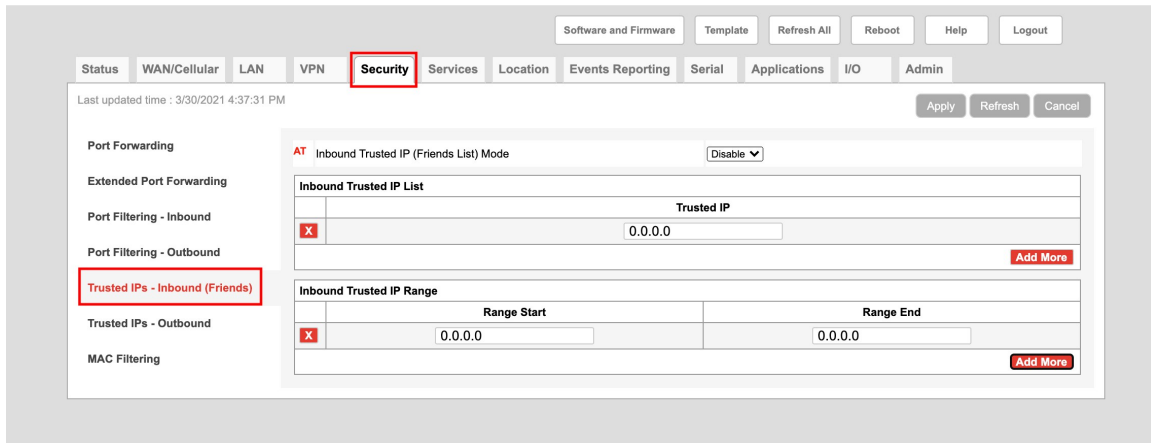

### CAUTION:

Only set a Trusted IP address if you are familiar with the use of IP addresses. Consult your IT department or Campbell Scientific for assistance.

### NOTE:

This setting does not affect outbound connections, only incoming connections.

## 3. Initial inspection

The RV50(X) ships with the following items:

- (1) gray power cable (from original manufacturer)
- (4) screws and washers (from original manufacturer)
- (1) 2 ft Ethernet cable
- (1) Quick Deploy Guide for private dynamic IP addresses
- (1) Quick Deploy Guide for public static IP addresses

Upon receipt of the RV50(X), inspect the package and contents for damage. File any damage claims with the shipping company.

Immediately check package contents against the shipping documentation. Contact Campbell Scientific about any discrepancies.

# 4. Pre-installation

---

**TIP:**

Check [www.campbellsci.com](http://www.campbellsci.com)  to ensure you are using the latest data logger support software and data logger operating system (OS).

Updating the OS during system setup and testing, or onsite is recommended. Sending an OS to a remote data logger will interrupt the data logger program. If you have questions, contact Campbell Scientific for assistance (<https://www.campbellsci.com/support> .

## 4.1 Establish cellular service

For better security, we recommend using Konect PakBus® Router with a private dynamic IP address. This method allows only incoming PakBus communication. No other incoming communication is supported. However, all forms of outbound communication from the data logger are supported, including but not limited to PakBus, email, and FTP.

A public static IP address can also be used. This provides more incoming communication functionality, but is less secure and more vulnerable to unsolicited traffic.

**NOTE:**

A public static IP account must be used when the module is set up in serial server mode. Private dynamic IP accounts do not support the serial server mode.

### 4.1.1 Campbell Scientific cellular data service

Campbell Scientific can provide subscriptions to cellular service through Verizon, AT&T, T-Mobile, Vodafone, Telstra, and over 600 other providers worldwide. When this cellular service is purchased with the module, the module will come pre-provisioned with the required SIM card and APN. If you have already purchased the RV50(X), call Campbell Scientific to set up service.

### 4.1.2 Other service providers

While using Campbell Scientific is the simplest way to obtain cellular data service for your module, you can go directly to a provider. For more information on obtaining service directly from Verizon and AT&T, see [Verizon Wireless and AT&T](#) (p. 52).

**TIP:**

Prepaid cellular data plans may experience service slow downs when data limits are reached. If file transfer from a cellular-connected data logger works initially, but later has problems, check for data coverage on the cellular plan.

This does not apply to Campbell Scientific cellular data services.

## 4.2 Install the SIM card

**NOTE:**

If you purchased cellular service from Campbell Scientific with the module, it will come with the SIM (Subscriber Identity Module) card already installed. Proceed to [Konect PakBus Router setup](#) (p. 6)

The RV50(X) requires a Mini-SIM (2FF); a smartcard that securely stores the key identifying a mobile subscriber. You should only need to install the SIM once in the life of the module.

To install the SIM card:

1. Remove the SIM card cover.
2. Note the location of the notched corner for correct alignment. The gold contact points of the SIM face down when inserting the SIM card as shown in the following figure. **Gently** slide the card into the slot until it stops and locks into place. To eject the SIM card, press it in slightly and release.
3. Replace the SIM card cover.



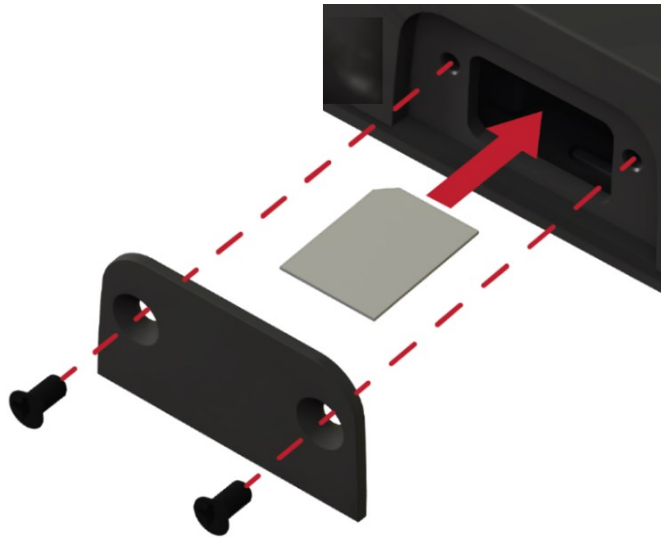



FIGURE 4-1. SIM card installation

## 4.3 Konect PakBus Router setup

For better security, we recommend using Konect PakBus® Router with a private dynamic IP address. This method allows only incoming PakBus communication. No other incoming communication is supported. However, all forms of outbound communication from the data logger are supported, including but not limited to PakBus, email, and FTP.

### 4.3.1 Get started

You will need the Konect PakBus Router redemption code that came on a card with the RV50(X).



**Konect**  
Data Services from Campbell Scientific

*Safe, secure routing for access to your IP-connected datalogger*

**Important Information! Do not discard!**  
Activate a Complimentary PakBus® Router on Campbell Scientific's Konect PakBus Routing Service. See the Getting Started Guide at:  
**<http://campbellsci.com/start/pbrouter>**

REDEMPTION CODE [REDACTED]

Open a web browser and go to [www.konectgds.com](http://www.konectgds.com) .

First-time users need to create a **free account**. After you submit your information, you will receive two emails up to five minutes apart. One email will contain a Passport ID and the other your Password. If emails are not received, check your email junk folder.



### 4.3.2 Set up Konec PakBus Router

1. Sign in to [www.konecogs.com](http://www.konecogs.com) using your Passport ID and Password found in the two received emails. Once logged in, you will be at the Welcome page.

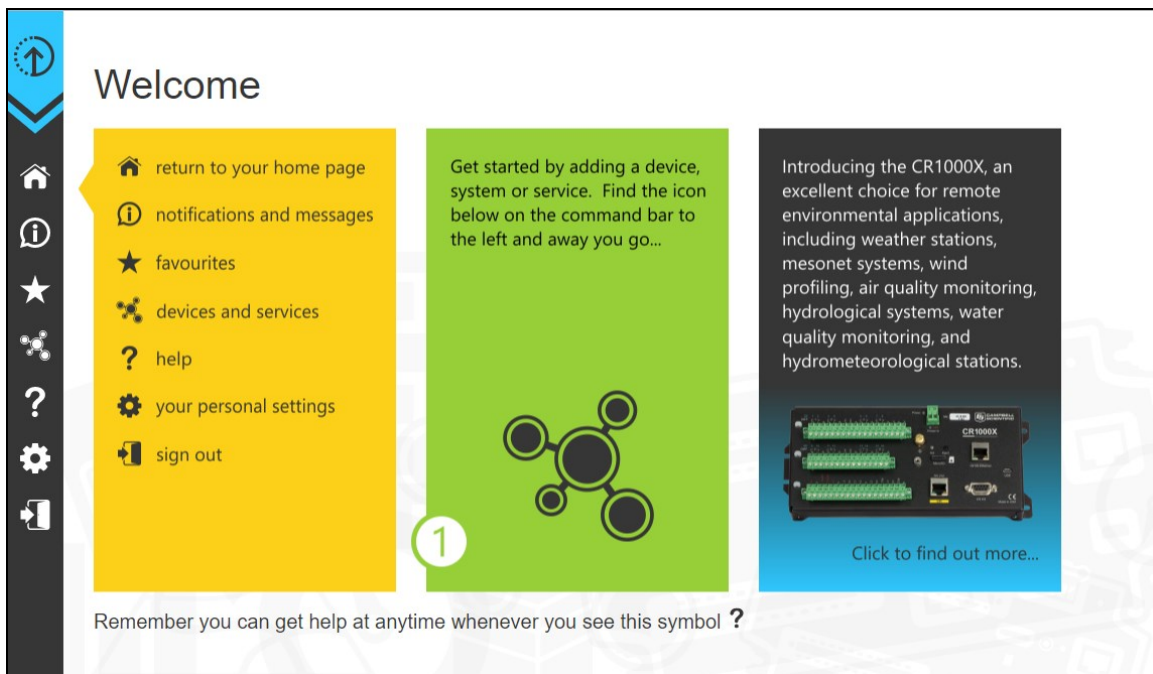

2. Click **Devices and services**  on the command bar to the left and select **Redeem PakBus Router Code**. Enter your complimentary Router Code found on the included card with your cellular-enabled device and click **Submit**.

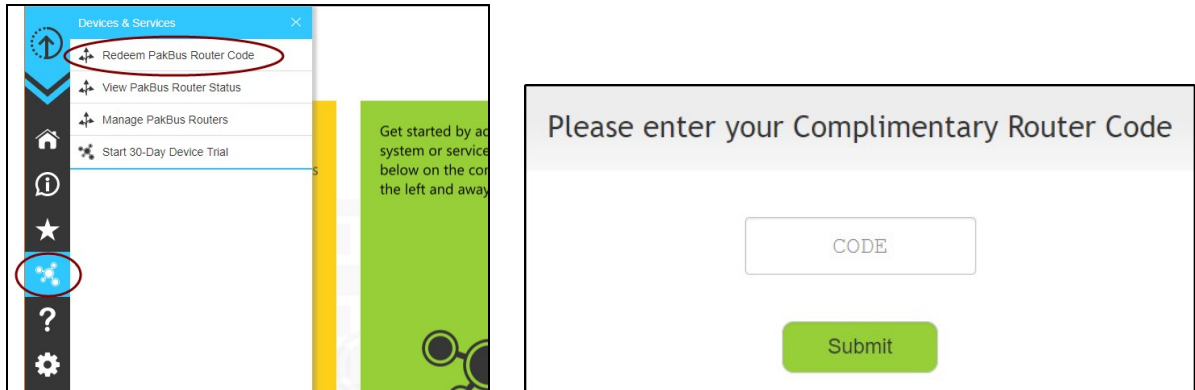

3. The next screen shows the assigned **DNS** address and **Port** for the router. Enter a **TCP Password** and select a unique **PakBus Address** for your data logger.

**TIP:**  
**Make note of this information;** it will be required for data logger configuration as well as LoggerNet setup. Please note your **DNS, Port, TCP Password** and **PakBus address;** you will need them later.

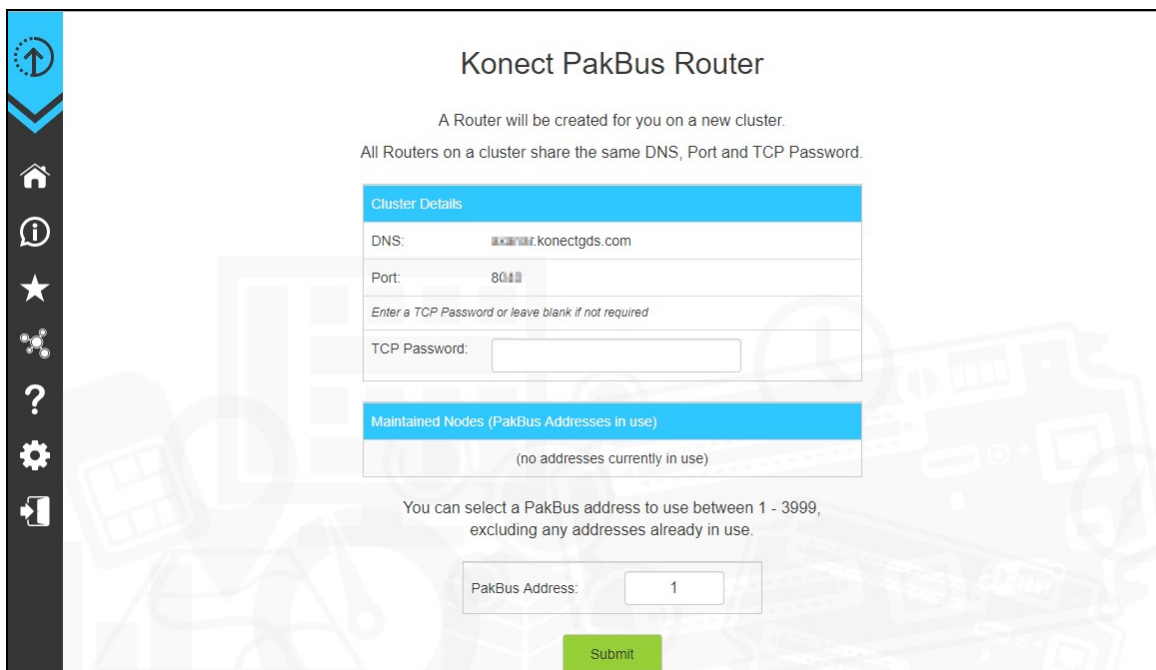

4. Click **Submit**.

5. To edit settings at a later date, click **devices and services**  on the command bar and select **Manage PakBus Routers**.

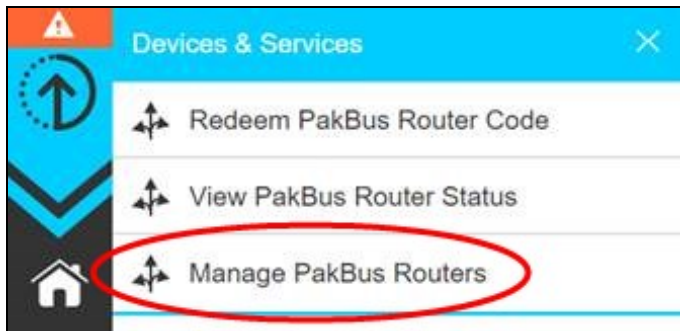

**NOTE:**

The DNS address and **Port** number, assigned when your account was setup, cannot be edited.

## 5. QuickStart

---

The Provisioning Report received with your Cellular Data Service shows whether the module was configured with a private dynamic or public static IP address. See the following figures for examples of Campbell Scientific Provisioning Reports. Other cellular providers should provide similar information.



### Cellular Data Service Provisioning Report

The following device has been provisioned for Campbell Scientific Cellular Data Service.

Sales Order #	12/31/1969	Sales Order Due Date	12/31/1969
Sales Order Date	12/31/1969	Date Provisioned	11/06/2018
Company	Campbell Scientific Inc Marketing	Customer ID	10000
Address	2000 875 W 1900 N	Contact	
City	Logan	Phone	435 227 9600
State	UT	Email	www@campbellsci.com
Country	United States		
Postal Code	84301-1704		
Hardware Model #	9900-17	Datalogger (-40 to +70C) -CELL210 w4G LTE CAT1 VZ -VS Verizon US Static IP	
Serial #	9900-CELL210-VS	Static IP	
Provision Code	9900-17	CR300-CELL210-VS	Datalogger (-40 to +70C) -CELL210 w4G LTE CAT1 VZ -VS Verizon US Static IP
Data Plan	9900-14	CELLDATA-VS-A250	Campbell Scientific Cellular Data Service Subscription -VS Verizon US Static IP - A250 250MB/Mon for 1 Yr
Data Limit	10000	Network	Verizon
ICCID	89010000000000000000000000000000	IP Address	166.167
MSISDN	001-435-2278	KonecT Pak Bus Rol	IP Address 166.167
IMEI	89010000000000000000000000000000	Redemption Code	
Renewal Due Date	2019-09-22	Service Period	11/15/2018 to 12/14/2019

FIGURE 5-1. Static IP provisioning report

### Cellular Data Service Provisioning Report

The following device has been provisioned for Campbell Scientific Cellular Data Service.

Sales Order #	329081	Sales Order Due Date	03/23/2018
Sales Order Date	03/23/2018	Date Provisioned	03/23/2018
Company	Campbell Scientific Inc Marketing	Customer ID	10000
Address	2000 875 W 1900 N	Contact	
City	Logan	Phone	435 227 9600
State	UT	Email	www@campbellsci.com
Country	United States		
Postal Code	84301-1704		
Hardware Model #	9900-18	Datalogger (-40 to +70C) -CELL200 w9G GSM -IT1B International 1B	
Serial #	9900-CELL200-IT1B		
Provision Code	9900-18	CELLPROV-IT1B	Cellular Data Modem Provisioning for User Supplied modem -IT1B International 1B
Data Plan	9900-18	CELLDATA-IT1B-A25	Campbell Scientific Cellular Data Service Subscription -IT1B International 1B -A25 25MB/Mon for 1 Yr
Data Limit	10000	Network	International 1B
ICCID	89010000000000000000000000000000	IP Address	Private Dynamic
MSISDN	001-435-2278	KonecT Pak Bus Rol	IP Address Private Dynamic
IMEI	89010000000000000000000000000000	Redemption Code	
Renewal Due Date		Service Period	04/01/2018 to 03/31/2019

FIGURE 5-2. Private dynamic IP provisioning report

Additionally, Campbell Scientific cellular modules configured with a public static IP address will have two stickers on the module. One sticker will show the module phone number and data plan. The second sticker will show the static IP address. Campbell Scientific cellular modules configured with a private dynamic IP address will have one sticker on the module. It will show the module phone number and data plan.

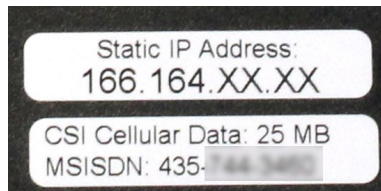

FIGURE 5-3. Module with public static IP address

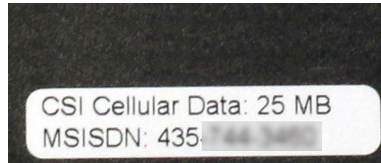

FIGURE 5-4. Module with private dynamic IP address

## 5.1 Modules using Konect PakBus Router (private dynamic IP)

### 5.1.1 Configure RV50(X)

1. Download the collection of RV50(X) configuration templates from [www.campbellsci.com/downloads](http://www.campbellsci.com/downloads) and run the executable downloaded.
2. Connect the **Cellular** antenna.
3. Connect the **Diversity** antenna, if used. Use of a diversity antenna is recommended, it can improve system performance. It is required in 4G networks, but not 2G or 3G. Note: If a **Diversity** antenna is not used on a 2G or 3G cellular network, use **ACEmanager** to disable **WAN/Cellular > Network Credentials > RX Diversity**.
4. Connect the power cable wires to a power supply.

Wire Color	Function	Connect To
Black	Ground	G
White	Enable (On/Off)	12V or SW12V or control port
Red	Power (7 to 36 V)	12V

5. Connect the power cable to the RV50(X) **DC Power** input. When the RV50(X) is properly set up and powered, the status LEDs will turn on. The RV50(X) will begin the activation/provisioning process and attempt to connect to the mobile network. This process typically takes 5 to 10 minutes. A successful connection is indicated by a solid green or solid amber **Network** LED.

**NOTE:**

If Campbell Scientific did not provision the RV50(X) or it does not automatically connect to the network, you may need to confirm or enter your APN information. Follow steps 6 through 8 to **WAN/Cellular > SIM Slot 1 Configuration > Network Credentials > User Entered APN**.

6. Connect your Windows® computer to the RV50(X) using the supplied Ethernet cable.

**CAUTION:**

Your computer may use the RV50(X) as a network interface while connected resulting in cellular data usage. Campbell Scientific recommends disconnecting the computer from the RV50(X) as soon as configuration is complete.

7. Launch a web browser, and enter <https://192.168.13.31:9443> into the address bar. The *ACEmanager* login screen should appear in your browser.

**NOTE:**

RV50(X)s running OS version 4.13 and older had both HTTP port 9191 and HTTPS port 9443 enabled by default. When using HTTP (not HTTPS) with these older OS versions, enter the IP address using port number 9191, for example, <http://192.168.13.31:9191>.

8. Look for a sticker on the bottom of your modem with the manufacturer-generated default password. Log in using **User Name** = user and that **Password**. If there is no sticker try 12345 for the password. Make note of the password used so it can be easily referenced when off site. Remote access to the modem interface will require the password.

**TIP:**

We strongly recommend changing the default password to prevent unauthorized access and the potential of malware infection. The password can be changed from the **Admin** tab.

**WARNING:**

Failure to set a strong password in the RV50(X) may result in misuse of the modem by malware or hackers. Significant data overage charges may apply.

- Once logged in, check the **Status > Home > Network State** field. It should read Network Ready, indicating the RV50(X) is connected to the cellular network. You can easily test the RV50(X) connection to the Internet by selecting the **Admin > Advanced** tab and using the PING tool to ping an Internet server, such as [www.campbellsci.com](http://www.campbellsci.com).

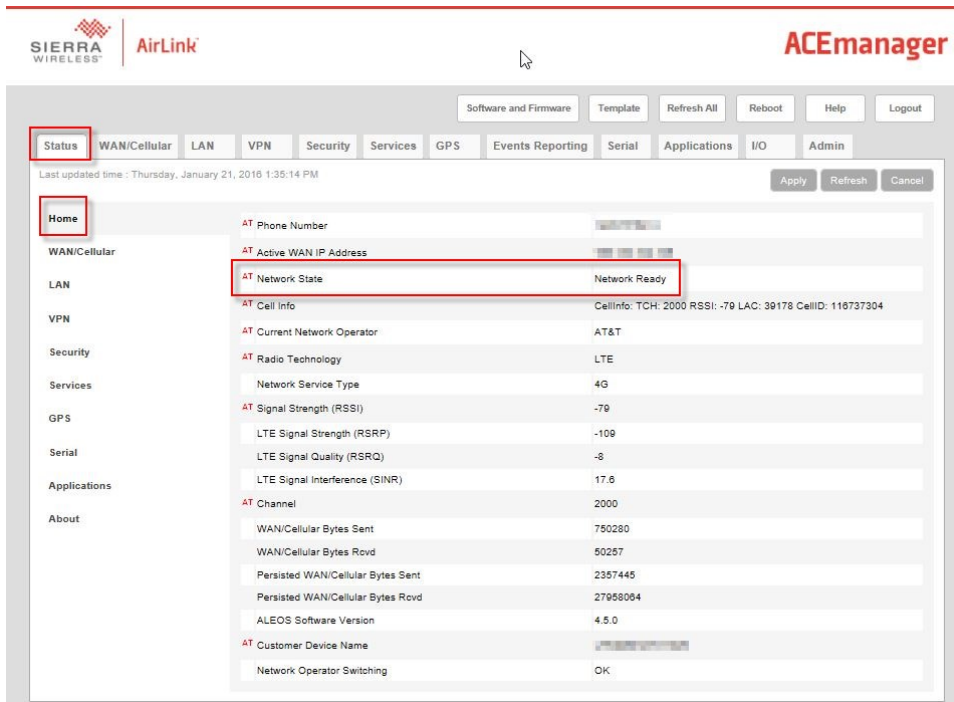

- Click the Template button in the **ACEmanager** toolbar. A template application window will appear. Browse to and upload one of the configuration templates downloaded from Campbell Scientific.

Template Files	
Template File Name	Description
RV50_115200.xml	Default configuration with RS-232 at 115200 baud and Ethernet communication enabled. <sup>1</sup>
RV50_9600.xml	Default configuration with RS-232 at 9600 baud and Ethernet communication enabled. <sup>2</sup>
<sup>1</sup> CR1000X series, CR300 series, CR6 series, CR1000, CR3000, CR800 series, CR5000, and GRANITE 6/9/10	
<sup>2</sup> CR10X, CR10X-PB, CR510, CR510-PB, CR23X, CR23X-PB, and CR200(X) series data loggers	

- Reboot the RV50(X) after successfully applying the configuration template. You can do this by clicking the Reboot button on the **ACEmanager** toolbar, by momentarily pressing the Reset button (2 sec), or by temporarily removing power from the RV50(X).



## 5.1.2 Enabling PPP mode

Launch the Device Configuration Utility . All tabs are within the **Deployment** category.

On the **Datalogger** tab, change the data logger **PakBus Address** and **PakBus/TCP Password** to match the values entered in the [Set up Konect PakBus Router](#) (p. 7) step.



The screenshot shows the 'Datalogger' configuration window. The 'Datalogger' tab is selected. The 'PakBus Address' is set to 101. The 'PakBus Security' section is expanded, showing 'Security Code 1', 'Security Code 2', and 'Security Code 3' all set to 0. The 'PakBus/TCP Password' and 'Confirm PakBus/TCP Password' fields are highlighted with a red box.

On the **Com Ports Settings** tab, select the **COMPort** where the module is connected; this is generally RS-232. Change the **Baud Rate** to **115200 Fixed**.

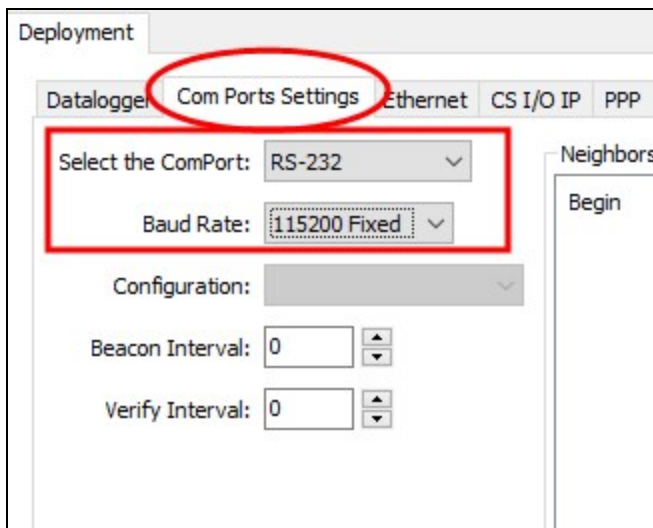

The screenshot shows the 'Com Ports Settings' configuration window. The 'Com Ports Settings' tab is selected. The 'Select the ComPort' is set to RS-232. The 'Baud Rate' is set to 115200 Fixed. The 'Neighbors' section is visible on the right.

On the **PPP** tab select the **Config/Port Used** where the modem is connected. This is the same as was selected on the **Com Ports Settings** tab. Set **Modem Dial String** to `ATH;AT\APPP`.

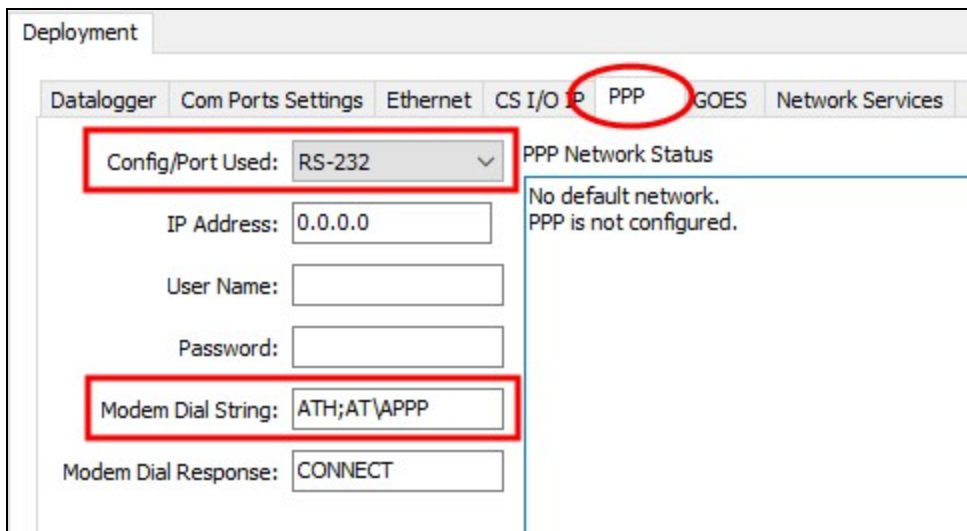

On the **Network Services** tab, in the **PakBus/TCP Clients** box, type the DNS address and Port number noted during the [Set up Konect PakBus Router](#) (p. 7) step.

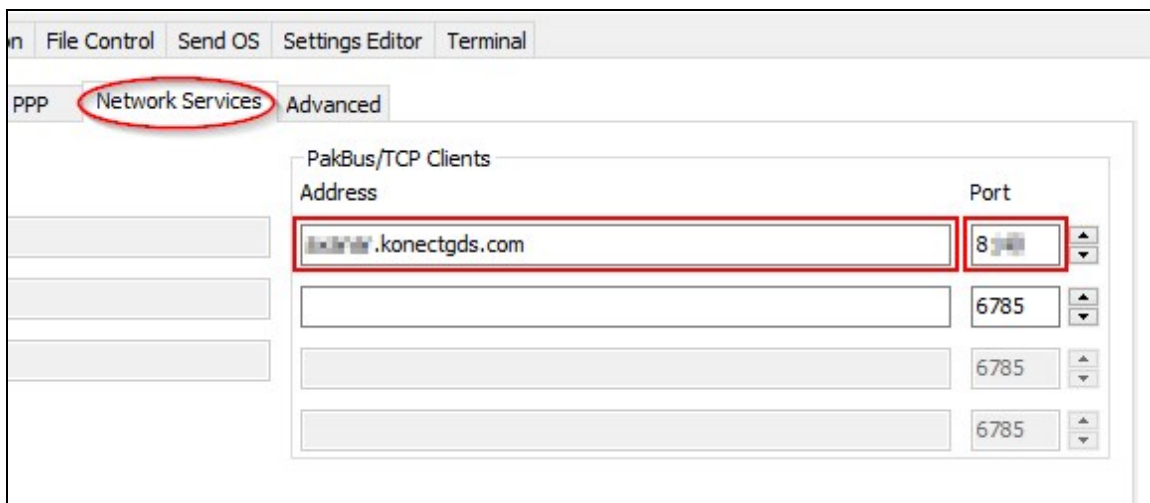

**Apply** to save your changes.

Disconnect the Ethernet cable between the RV50(X) and computer.

## 5.1.3 Set up LoggerNet

The LoggerNet Network Map is configured from the **LoggerNet Setup** screen.

### NOTE:

Setup has two options, EZ (simplified) and Standard. Click on the **View** menu at the top of the **Setup** screen, and select **Standard** view.

From the LoggerNet toolbar, click **Main > Setup** and configure the Network Map as described in the following steps:

1. Select **Add Root > IPPort**.
2. Select **PakBusPort** and **pbRouter** for PakBus data loggers such as the CR6 or CR1000X.

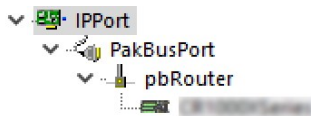

### NOTE:

PakBus data loggers include the following models: GRANITE-series, CR6, CR3000, CR1000X, CR800-series, CR300-series, CR1000, and CR200(X)-series.

3. Add a data logger to the **pbRouter**.
4. From the Entire Network, on the left side, select the **IPPort**. Enter the Konect PakBus Router DNS address and port number as noted in the Konect PakBus Router setup ([Set up Konect PakBus Router](#) (p. 7)). Enter them into the **Internet IP Address** field in the format DNS:Port with a colon separating DNS and Port. For example, axanar.konectgds.com:pppp where pppp is the port number.

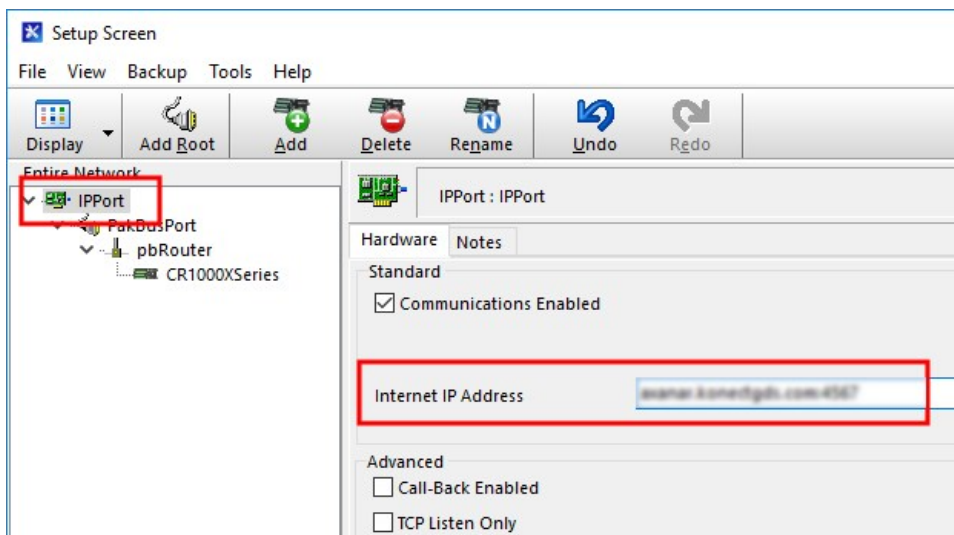

5. Leave the default settings for the **PakBusPort**. **PakBus Port Always Open** should **not** be checked. In the **TCP Password** field enter the TCP Password; this must match the value entered in the Konect PakBus Router setup and LoggerNet setup.

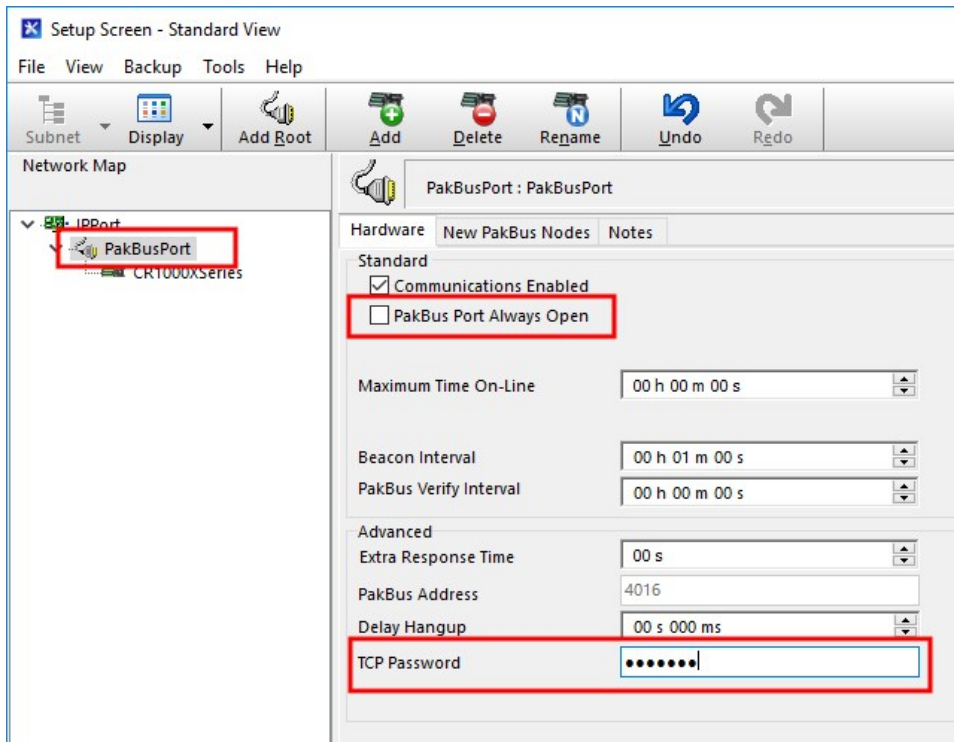

- For PakBus data loggers, select the pbRouter in the Network Map and set the **PakBus Address** to 4070.

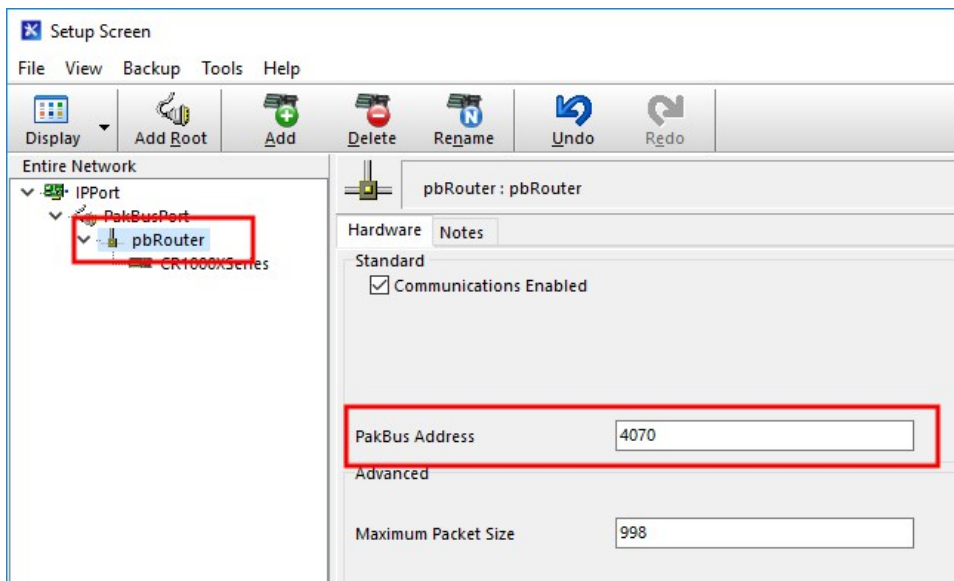

- For PakBus data loggers, select the data logger in the Network Map and set the **PakBus Address** to match that of the data logger (default address in the data logger is 1). If a **PakBus Encryption Key** was entered during data logger setup, also enter it here. Click **Apply** to save the changes.

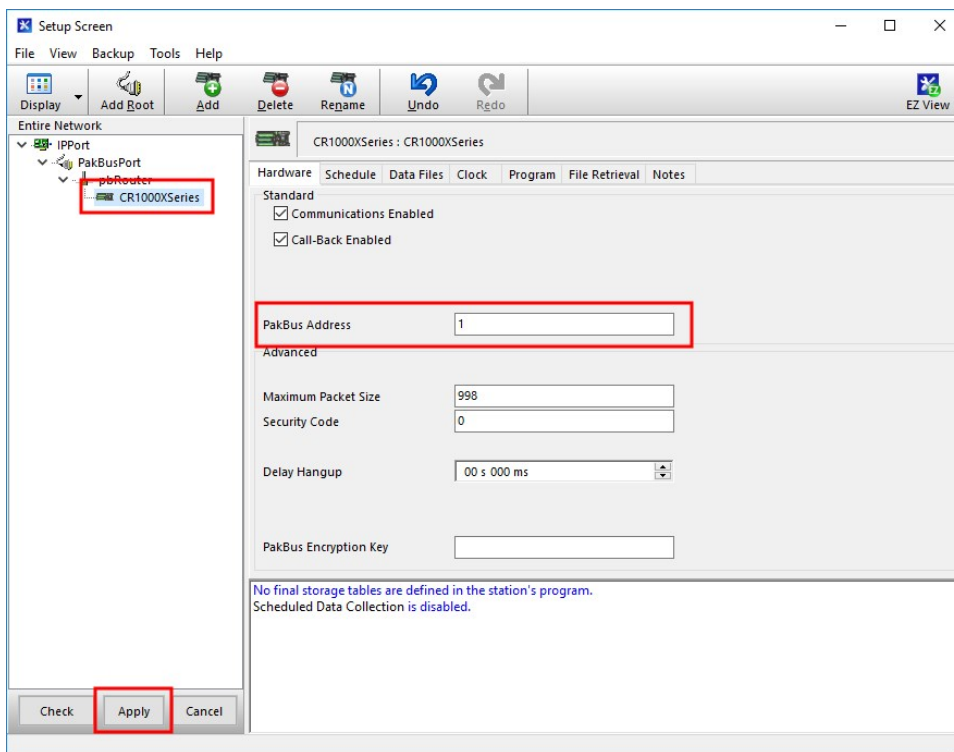

## 5.1.4 Test the connection

After the Network Map has been configured, test the cellular connection by using the **Connect** screen as shown in the following image. Click on the appropriate station and click **Connect** to initiate a call to the data logger.

### TIP:

The connection time is subject to many external factors. It is often less than 30 seconds but could be up to 15 minutes. Be patient.

If the connection is successful, the connectors at the bottom of the screen will come together and clock information from the data logger will be displayed in the **Station Date/Time** field. If the connection fails, a **Communications Failure** message will be displayed.

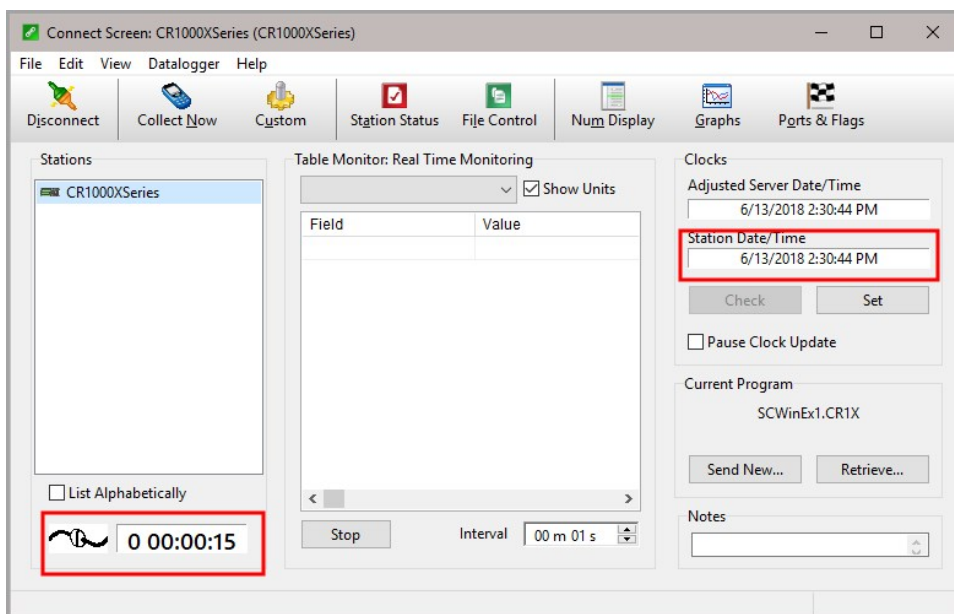

## 5.2 Modules using a public static IP

### 5.2.1 Configure RV50(X)

1. Download the collection of RV50(X) configuration templates from [www.campbellsci.com/downloads](http://www.campbellsci.com/downloads) and run the executable downloaded.
2. Connect the **Cellular** antenna.

3. Connect the **Diversity** antenna, if used. Use of a diversity antenna is recommended, it can improve system performance. It is required in 4G networks, but not 2G or 3G. Note: If a **Diversity** antenna is not used on a 2G or 3G cellular network, use **ACEmanager** to disable **WAN/Cellular > Network Credentials > RX Diversity**.
4. Connect the power cable wires to a power supply.

Wire Color	Function	Connect To
Black	Ground	G
White	Enable (On/Off)	12V or SW12V or control port
Red	Power (7 to 36 V)	12V

5. Connect the power cable to the RV50(X) **DC Power** input. When the RV50(X) is properly set up and powered, the status LEDs will turn on. The RV50(X) will begin the activation/provisioning process and attempt to connect to the mobile network. This process typically takes 5 to 10 minutes. A successful connection is indicated by a solid green or solid amber **Network** LED.

**NOTE:**

If Campbell Scientific did not provision the RV50(X) or it does not automatically connect to the network, you may need to confirm or enter your APN information. Follow steps 6 through 8 to **WAN/Cellular > SIM Slot 1 Configuration > Network Credentials > User Entered APN**.

6. Connect your Windows® computer to the RV50(X) using the supplied Ethernet cable.

**CAUTION:**

Your computer may use the RV50(X) as a network interface while connected resulting in cellular data usage. Campbell Scientific recommends disconnecting the computer from the RV50(X) as soon as configuration is complete.

7. Launch a web browser, and enter <https://192.168.13.31:9443> into the address bar. The **ACEmanager** login screen should appear in your browser.

**NOTE:**

RV50(X)s running OS version 4.13 and older had both HTTP port 9191 and HTTPS port 9443 enabled by default. When using HTTP (not HTTPS) with these older OS versions, enter the IP address using port number 9191, for example, <http://192.168.13.31:9191>.

8. Look for a sticker on the bottom of your modem with the manufacturer-generated default password. Log in using **User Name** = user and that **Password**. If there is no sticker try 12345 for the password. Make note of the password used so it can be easily referenced when off site. Remote access to the modem interface will require the password.

**TIP:**

We strongly recommend changing the default password to prevent unauthorized access and the potential of malware infection. The password can be changed from the **Admin** tab.

**WARNING:**

Failure to set a strong password in the RV50(X) may result in misuse of the modem by malware or hackers. Significant data overage charges may apply.

9. Once logged in, check the **Status > Home > Network State** field. It should read Network Ready, indicating the RV50(X) is connected to the cellular network. You can easily test the RV50(X) connection to the Internet by selecting the **Admin > Advanced** tab and using the PING tool to ping an Internet server, such as www.campbellsci.com.

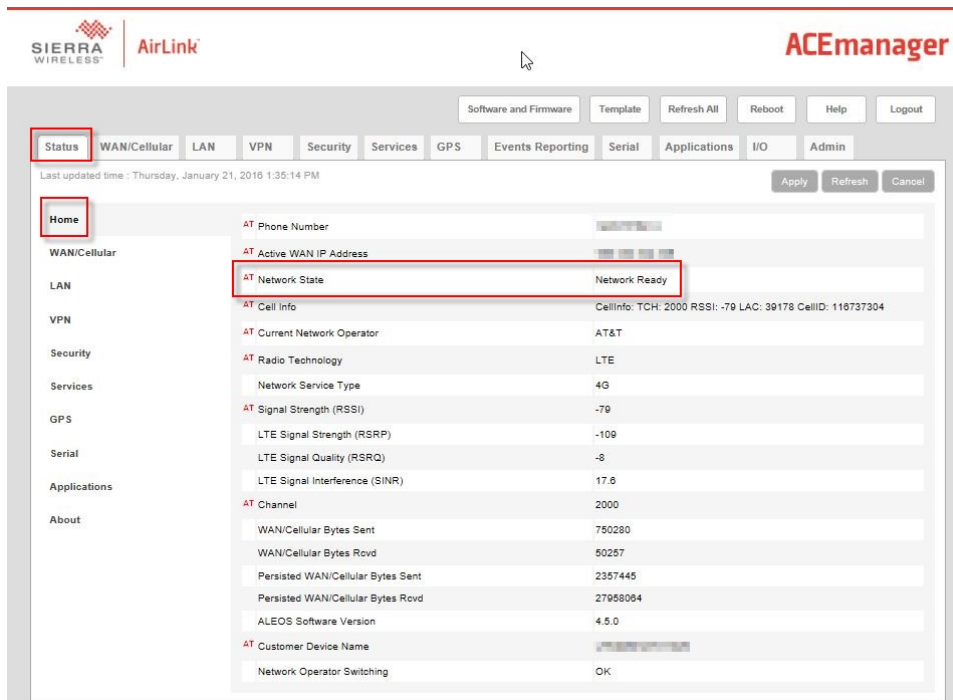



- Click the Template button in the **ACEManager** toolbar. A template application window will appear. Browse to and upload one of the configuration templates downloaded from Campbell Scientific.

Template Files	
Template File Name	Description
RV50_115200.xml	Default configuration with RS-232 at 115200 baud and Ethernet communication enabled. <sup>1</sup>
RV50_9600.xml	Default configuration with RS-232 at 9600 baud and Ethernet communication enabled. <sup>2</sup>
<sup>1</sup> CR1000X series, CR300 series, CR6 series, CR1000, CR3000, CR800 series, CR5000, and GRANITE 6/9/10	
<sup>2</sup> CR10X, CR10X-PB, CR510, CR510-PB, CR23X, CR23X-PB, and CR200(X) series data loggers	

- Reboot the RV50(X) after successfully applying the configuration template. You can do this by clicking the Reboot button on the **ACEManager** toolbar, by momentarily pressing the Reset button (2 sec), or by temporarily removing power from the RV50(X).

## 5.2.2 Additional security (optional but recommended)

To prevent unwanted data usage when using a public static IP, consider doing the following:

- Limit open ports – Limit the number of configured ports that the RV50(X) is listening on. Open ports increase the chance of unwanted exploitation resulting in higher data usage and possible equipment misuse.

The **ACEManager** template provided by Campbell Scientific limits these ports for you. Only the ports needed for communications with your data logger are opened. It is important to load the template prior to adding or deleting any additional ports.

- Set Trusted IPs – The RV50(X) Trusted IP list limits devices that the RV50(X) will respond to. This requires entering the public IP address of each computer that will connect with or through the RV50(X). Each computer must have an unchanging public IP address set in **ACEManager** on the **Security** tab in the **Trusted IPs - Inbound (Friends)** field.

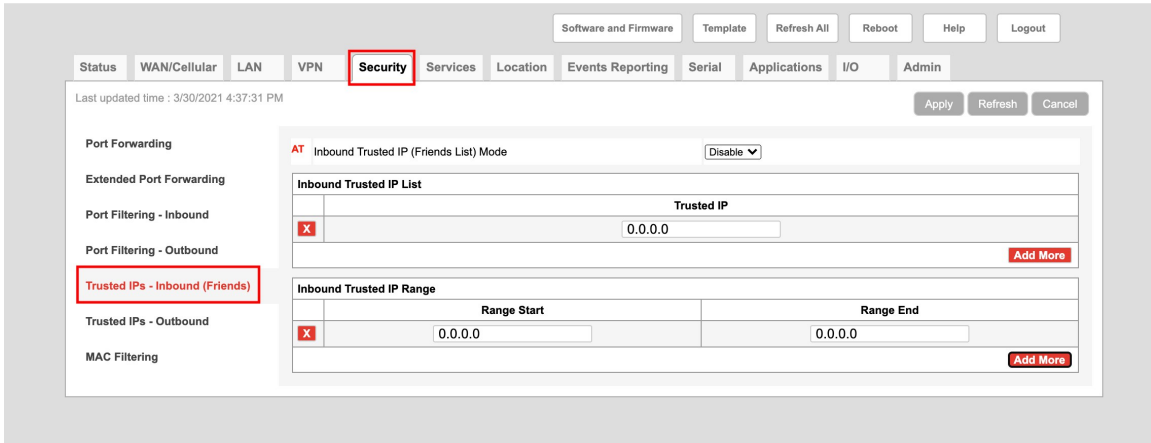

**CAUTION:**

Only set a Trusted IP address if you are familiar with the use of IP addresses. Consult your IT department or Campbell Scientific for assistance.

**NOTE:**

This setting does not affect outbound connections, only incoming connections.

### 5.2.3 Enabling PPP mode

Launch the Device Configuration Utility . All tabs are within the **Deployment** category. On the **Datalogger** tab, make note of the data logger **PakBus Address** (default address is 1).

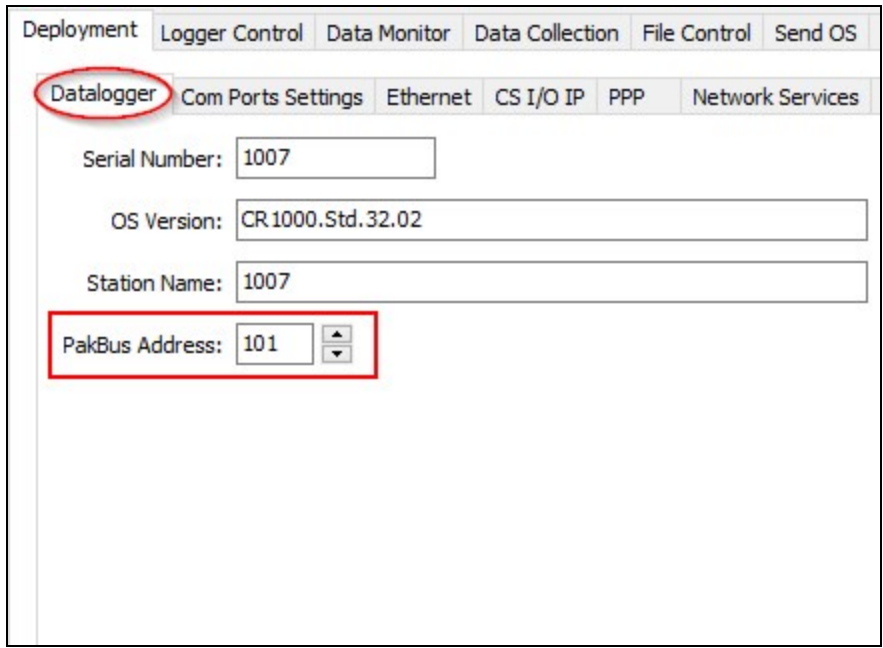

On the **Com Ports Settings** tab, select the **COMPort** where the module is connected; this is generally RS-232. Change the **Baud Rate** to **115200 Fixed**.

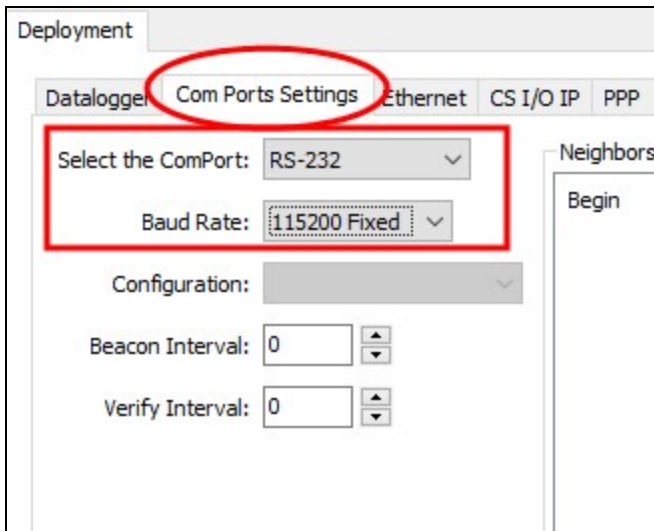

On the **PPP** tab select the **Config/Port Used** where the modem is connected. This is the same as was selected on the **Com Ports Settings** tab. Set **Modem Dial String** to **ATH;AT\APPP**.

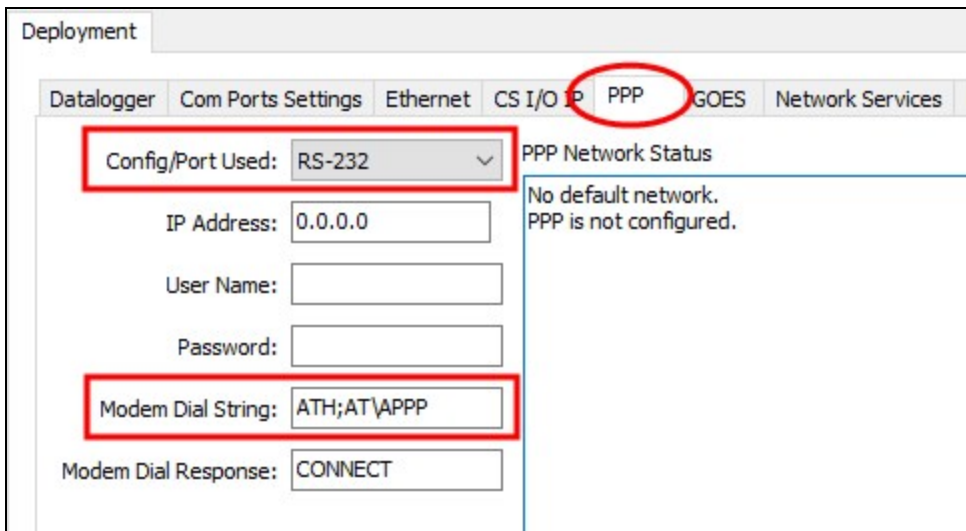

**Apply** to save your changes.

Disconnect the Ethernet cable between the RV50(X) and computer.

## 5.2.4 Set up LoggerNet

The LoggerNet Network Map is configured from the **LoggerNet Setup** screen.

**NOTE:**

Setup has two options, EZ (simplified) and Standard. Click on the **View** menu at the top of the **Setup** screen, and select **Standard** view.

From the LoggerNet toolbar, click **Main > Setup** and configure the Network Map as described in the following steps:

1. Select **Add Root > IPPort**.
2. Select **PakBusPort**
3. Add a data logger to the **PakBusPort**.
4. Select the **IPPort** in the Network Map. Enter the RV50(X) IP address and port number. The IP address and port number are input in the **Internet IP Address** field separated by a colon. Preceding zeros are not entered in the **Internet IP Address** (for example, 070.218.074.247 is entered as 70.218.74.247). The default port number is 6785.

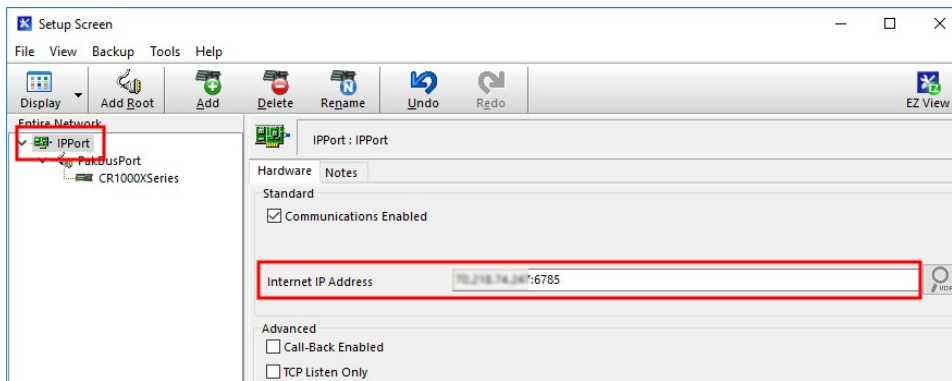

- For PakBus data loggers, leave the default settings for the **PakBusPort**. **PakBus Port Always Open** should **not** be checked. If used, enter the **TCP Password**.

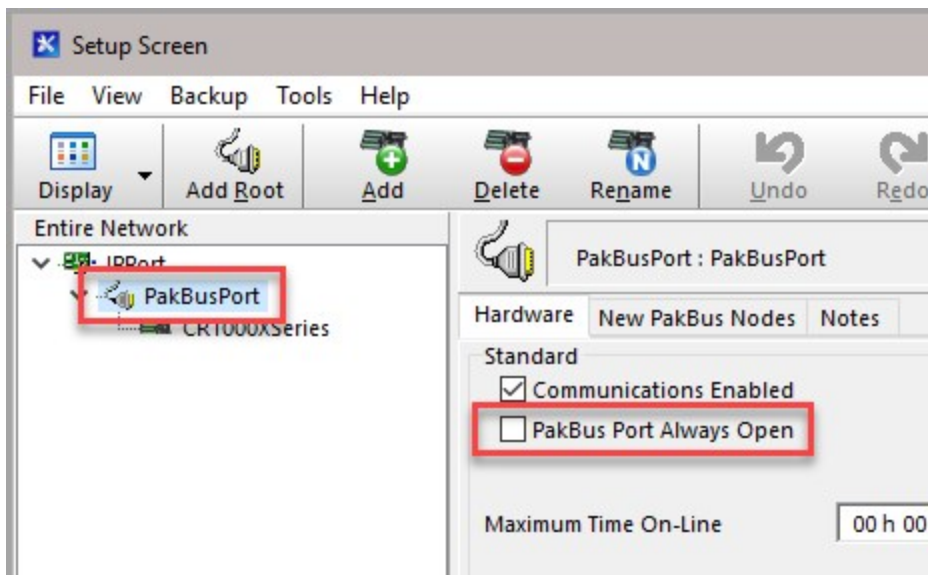

- For PakBus data loggers, select the data logger in the Network Map and set the **PakBus Address** to match that of the data logger (default address in the data logger is 1). If a **PakBus Encryption Key** was entered during data logger setup, also enter it here. Click **Apply** to save the changes.

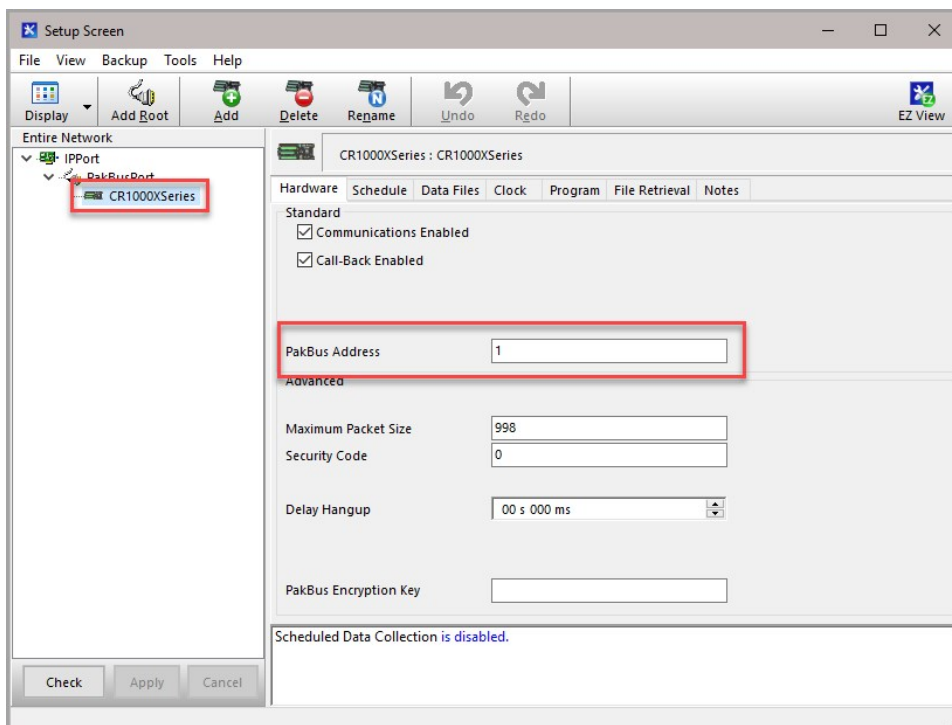

## 5.2.5 Test the connection

After the Network Map has been configured, test the cellular connection by using the **Connect** screen as shown in the following image. Click on the appropriate station and click **Connect** to initiate a call to the data logger.

### TIP:

The connection time is subject to many external factors. It is often less than 30 seconds but could be up to 15 minutes. Be patient.

If the connection is successful, the connectors at the bottom of the screen will come together and clock information from the data logger will be displayed in the **Station Date/Time** field. If the connection fails, a **Communications Failure** message will be displayed.

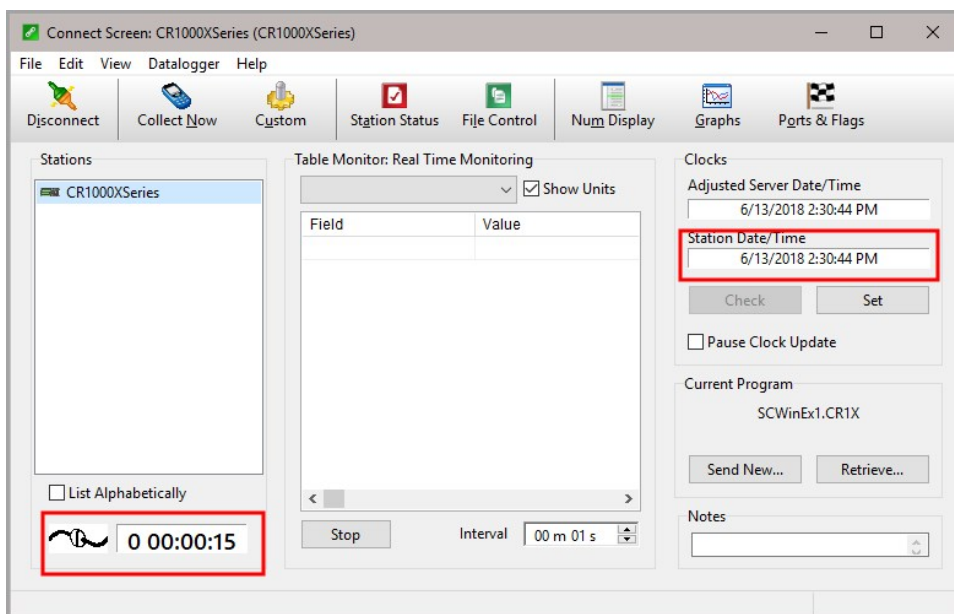

## 6. Specifications

Sierra Wireless® AirLink® RV50 (MC7355 radio module) and RV50X (MC7455 radio module) cellular modules

### Cellular WAN

- Network Technology: 4G with automatic fallback to 3G and 2G (RV50 only)
- See [https://s.campbellsci.com/documents/us/miscellaneous/Cellular Modem Frequency Bands.pdf](https://s.campbellsci.com/documents/us/miscellaneous/Cellular%20Modem%20Frequency%20Bands.pdf) for a complete list of supported frequency bands.

## Host Interfaces

- 10/100/1000 Ethernet RJ45
- RS-232 serial port, DB9 female
- USB version 2.0 with micro-B connector

## RF Connectors

- 3 SMA antenna connectors (primary, diversity & GPS)
- Active antenna support

## Power

- Operating Voltage: 7 to 36 Vdc
- Typical Enable/Ignition Sense Line Low: 1 mA @ 12V
- Typical Idle: 65 to 95 mA @ 12V, depending on configuration
- Typical Active: 250 to 300 mA @ 12V, depending on configuration

## Size

- Dimensions: 119 x 34 x 94 mm (4.69 x 1.34 x 3.7 in)
- Weight: 320 g (11.3 oz)

## Environmental

- Operating Temperature Range: –30 to 70 °C (–22 to 158 °F)
- Storage Temperature: –40 to 85 °C (–40 to 185 °F)
- Humidity: 90% @ 60 °C
- Military Specification: MIL-STD-810G conformance to shock, vibration, thermal shock, and humidity
- IP64 rated ingress protection

## Industry Certifications

- Safety: IECEE Certification Bodies Scheme (CB Scheme), UL60950
- Vehicle Usage: E-Mark (UN ECE Regulation 10.04), ISO7637-2, SAE J1455 (Shock & Vibration)
- Hazardous Environments: Class 1 Div 2
- Environmental: RoHS, REACH, WEEE

# 7. Installation

---

7.1 Base station requirements .....	29
7.2 Data logger site equipment .....	29
7.2.1 RV50(X) mounting kit .....	32
7.3 Wiring and connections .....	33
7.3.1 Module communications connections .....	33
7.3.2 Module power connections .....	34
7.3.3 Antenna connections .....	35
7.4 Hardware and software setup .....	36

## 7.1 Base station requirements

A computer running Campbell Scientific LoggerNet software with access to the Internet is needed.

## 7.2 Data logger site equipment

- RV50(X) module with power cable (included with module)
- Data logger — CR1000X series, CR300 series, CR6 series, CR1000, CR3000, CR800 series, CR5000, and GRANITE 6/9/10
- Module Interface, see [Module communications connections](#) (p. 33)
- Environmental Enclosure — ENC10/12, ENC12/14, ENC14/16 or ENC16/18

### If connecting to CS I/O port:

SC105 Interface — connects the module to any data logger with a CS I/O port. It must be configured using Device Configuration Utility. Settings should be:

- CS I/O Mode: SDC Address 8
- CS I/O ME Baud Rate: 115.2k
- RS-232 Mode: Modem (default)



- Baud Rate:
  - 115.2k fixed for CR1000X series, CR6 series, CR1000, CR3000, CR800 series, CR5000, and GRANITE 6/9/10 data loggers
  - 9600 for CR10X, CR10X-PB, CR510, CR510-PB, CR23X, and CR23X-PB data loggers
- 8 data bits, 1 stop bit, no parity

#### If connecting to RS-232 port:

Null Modem Cable (9 pin, male-to-male) — connects the module to the CR300 series, CR1000, CR3000, CR800 series, and CR200(X) series **RS-232** port.

CPI/RS-232 RJ45 to DB9 Cable — connects the module to the CR6 series or CR1000X series **CPI/RS-232** port.

#### If connecting to Ethernet port:

Ethernet cable - connects the module to CR6 or NLxxx.

- Antenna — the following antennas are available from Campbell Scientific. Contact Campbell Scientific for help in determining the best antennas for your application.
  - 2 dBd 4G/3G Omnidirectional Antenna: An omnidirectional antenna with mounting bracket that is ideally suited for use with 4G and 3G cellular gateways. The mounting bracket attaches to a mast or crossarm, and it serves as the antenna ground plane. The antenna has an N type (female) threaded permanent stud for easy mounting to the included bracket or through an enclosure wall. A coaxial cable, sold separately, is required to connect this antenna to the inline surge suppression or module antenna jack. The antenna includes a mount/U-bolt assembly for attaching the antenna to a mast, post, or crossarm up to 3.8 cm (1.5 in) in diameter.



- 8 dBd Yagi Wideband Antenna: A higher gain antenna that should be “aimed” at the service provider antenna. It covers both the 800-MHz band and the 1.9-GHz band. The antenna comes with bracket/U-bolt assembly for attaching the antenna to a mast or post. A coaxial cable, sold separately, is required to connect this antenna to the inline surge suppression or module antenna jack. This antenna is recommended

for areas that require a higher gain antenna.



- 4G/3G Cellular Whip Antenna with SMA Connector: A wideband termination antenna with SMA connector and articulating base. This antenna is intended for short-term testing use only. It is not intended for long-term use. Campbell Scientific recommends that customers use external antennas for the best reception and transmission of cellular signals.



**NOTE:**

When antennas are located away from the RV50(X), keep the cables as short as possible to prevent the loss of antenna gain. Route the cables to protect them from damage and so they will not be snagged or pulled on. Avoid binding or sharp corners in the cable routing. Bundle and tie off excess cable. Make sure the cables are secured so their weight will not loosen the connector from the RV50(X) over time.

**TIP:**

Cellular phone apps, such as OpenSignal (<https://opensignal.com/>), show the direction to point an antenna to get the best signal strength.

## 7.2.1 RV50(X) mounting kit

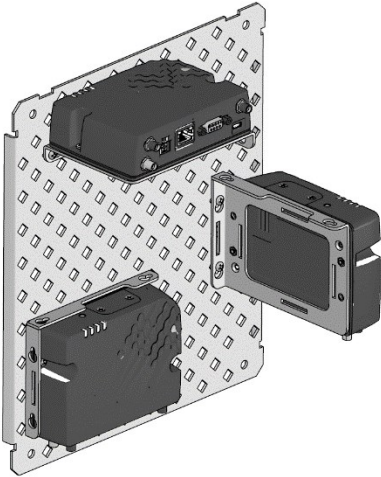

### 7.2.1.1 Mounting the RV50(X) flat on the backplate

Use the two included flat-head Phillips screws to mount the bracket to the backplate first. Then use two of the included pan-head Phillips screws to mount the RV50(X) to the bracket.

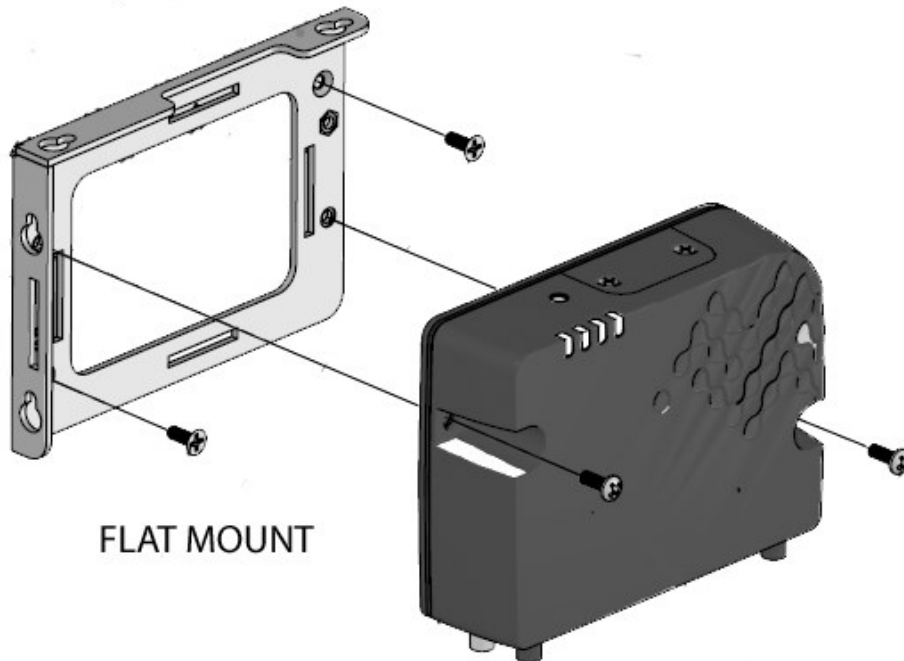

### 7.2.1.2 Mounting the RV50(X) on edge to the backplate

Use two of the included pan-head Phillips screws to mount the RV50(X) to the bracket. Then use two of the included pan-head Phillips screws to mount the bracket to the backplate.

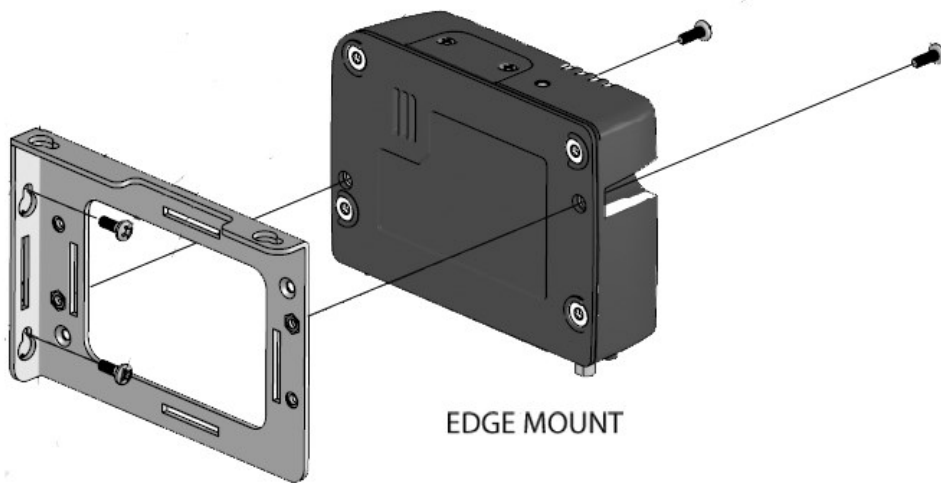

## 7.3 Wiring and connections

This section explains how to connect the module for different communications methods. It also describes how to power the module and connect an antenna.

### 7.3.1 Module communications connections

#### RS-232 connection using a null module cable

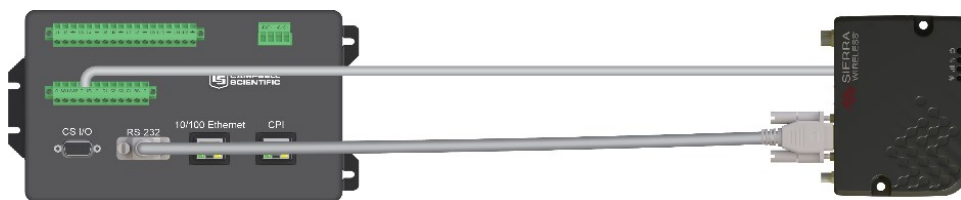

Null module Cable, is used to connect the module to the CR3000, CR800 series, CR2XX, CR300 series, CR1000, CR1000X series or CR5000 **RS-232** port.

#### RS-232 connection using a CPI/RS-232 cable



RS-232/CPI RJ45 to DB9 Male DTE, is used to connect the module to the CR6 or GRANITE 6/9/10.

## Ethernet connection

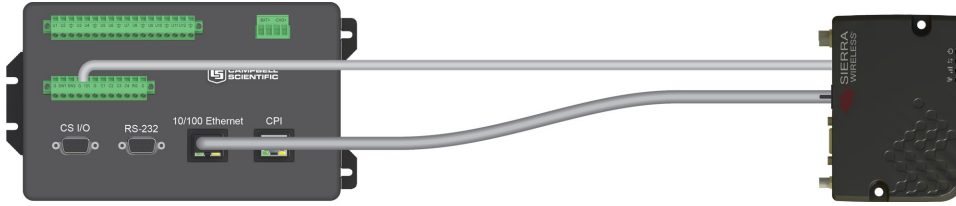

An Ethernet cable is used to connect the module to the **Ethernet** port of the data logger, NL1XX, or NL2XX.

## CS I/O connection using an SC105

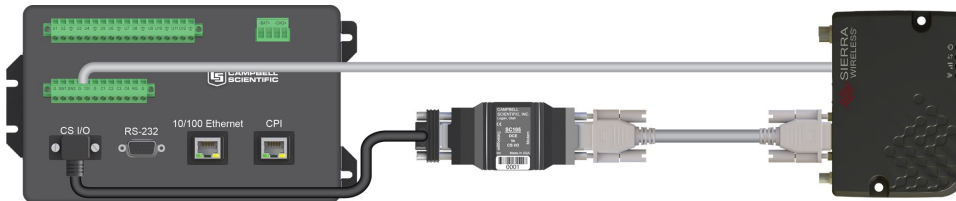

The SC105 interface is used to connect the module to a data logger **CS I/O** port. The SC105 can be connected directly to the module **RS-232** port. Alternatively, it can be connected to the module using the serial cable supplied with the SC105. The SC105 is attached to the data logger **CS I/O port** using the SC12 cable supplied with the SC105.

## 7.3.2 Module power connections

Connect the power cable to a power supply.

Wire Color	Function	Connect To
Black	Ground	G
White	Enable (On/Off)	12V or SW12V or control port
Red	Power (7 to 36 V)	12V

Connect the power cable to the RV50(X) **DC Power** input. When the RV50(X) is properly set up and powered, the status LEDs will turn on. The RV50(X) will begin the activation/provisioning process and attempt to connect to the mobile network. This process typically takes 5 to 10 minutes. A successful connection is indicated by a solid green or solid amber **Network** LED.

[Controlling power to the RV50\(X\)](#) (p. 48) provides an example CRBasic program using the **SW12()** instruction.

The **USB** port provides power for module configuration, but is not sufficient for normal operation.

### 7.3.3 Antenna connections



FIGURE 7-1. Antenna connections

1. Connect the cellular antenna to the **Cellular** antenna connector. Mount the cellular antenna so there is at least 20 cm between the antenna and the user or any bystander.
2. Connect a second antenna to the **Diversity** antenna connector.

Antenna diversity, also called space diversity, is a scheme that uses two or more antennas to improve the quality and reliability of a wireless link. Often, especially in urban and indoor environments, there is no clear line of sight between transmitter and receiver. Instead, the signal is reflected along multiple paths before finally being received. Each bounce can introduce phase shifts, time delays, attenuations, and distortions that can destructively interfere with one another at the aperture of the receiving antenna. Diversity-antenna-capable devices support multiple antennas (usually two) in order to combat this phenomenon and minimize its effects.

Diversity antennas are not required for 2G/3G connections; however, they are highly recommended in order to get the most reliable connection, especially in areas of low coverage. Identical or very similar antennas should also be used for the best results.

For 4G networks, the second antenna operates as a MIMO (multiple input, multiple output) antenna, providing a second receive path. This connection is required for operation on 4G/LTE networks.

Service	Frequency (MHz)	Wavelength ( $\lambda$ ) (mm)	Best antenna separation (mm) ( $1/2 \lambda$ )	Good antenna separation (mm) ( $1/4 \lambda$ )
LTE	700	428	214	107
LTE	800	375	187	94
LTE	900	333	167	83

**Table 7-1: Recommended antenna separation**

Service	Frequency (MHz)	Wavelength ( $\lambda$ ) (mm)	Best antenna separation (mm) ( $1/2 \lambda$ )	Good antenna separation (mm) ( $1/4 \lambda$ )
LTE	1800	167	83	42
LTE	2100	143	71	36
LTE	2600	115	58	29
WCDMA	850	353	176	88
WCDMA	900	333	167	83
WCDMA	1900	158	79	39
WCDMA	2100	143	71	36
CDMA/EV-DO	800	375	187	94
CDMA/EV-DO	1900	158	79	39
GSM/GPRS/EDGE	850	353	176	88
GSM/GPRS/EDGE	900	333	167	83
GSM/GPRS/EDGE	1800	167	83	42
GSM/GPRS/EDGE	1900	158	79	39

**WARNING:**

Antenna may not exceed the maximum gain specified in [RF exposure](#) (p. 54).

In more complex installations, such as those requiring long cable lengths or multiple connections, you must follow the maximum dBi gain guidelines specified by the radio communications regulations of the Federal Communications Commission (FCC), Industry Canada, ACMA in Australia, or your country's regulatory body.

## 7.4 Hardware and software setup

You will need to know how your RV50(X) was configured, either with a private dynamic or public static IP address. The Provisioning Report received from Campbell Scientific or another cellular provider should provide this information.

See [QuickStart](#) (p. 9) for more information.

# 8. Operation and maintenance

## 8.1 Ports

The **RS-232** port is the main port used with Campbell Scientific dataloggers. Its function is described throughout this manual.

The **USB** port is not used in Campbell Scientific applications.

The **Ethernet** port may be used in place of PPP Mode to get to the IP stack of the data logger. However, this method comes with higher current drain for both the module and the data logger. See [Using the RV50\(X\) Ethernet port](#) (p. 50) for more information.

## 8.2 LED indicator lights

When your RV50(X) is connected to power and an antenna, there is a specific pattern to the lights to indicate its operation mode as described in the following table:

LED	Color / Pattern	Description	LED Power Saving Mode
Power	Off	No power or input voltage $\geq 36$ VDC or $\leq 7$ VDC	
	Solid Green	Power is present.	
	Green with Amber Flash	Power is present and the modem has a GPS fix.	
	Solid Red	Standby mode	
	Flashing Green	When you press the reset button, flashing green indicates when to release the reset button to reboot the modem.	
	Flashing Red	When you press the reset button, flashing red indicates when to release the reset button to reset the modem to the factory default settings.	
	Flashing Amber	When you press the reset button for more than 20 seconds, flashing amber indicates when to release the reset button to enter Recovery mode.	



**Table 8-1: LED indicator lights**

LED	Color / Pattern	Description	LED Power Saving Mode
Signal	Solid Green	Good signal (equivalent to 4–5 bars)	Off
	Solid Amber	Fair signal (equivalent to 2–3 bars)	Off
	Flashing Amber	Poor signal (equivalent to 1 bar) If possible, Sierra Wireless® recommends moving the modem to a location with a better signal.	
	Flashing Red	Inadequate (equivalent to 0 bars) Sierra Wireless recommends moving the modem to a location with a better signal.	
<p><b>NOTE:</b> The quality of the signal strength is measured using the appropriate parameters for the radio technology in use.</p>			
Network	Solid Green	Connected to an LTE network	Off
	Solid Amber	Connected to a 3G network or 2G network (RV50 only)	Off
	Flashing Green	Connecting to the network	
	Flashing Red	No network available	
	Flashing Red / Amber	Network Operator Switching is enabled, but the modem is unable to locate the required firmware. For more information, refer to the ALEOS Software Configuration User Guide (Admin chapter) from the Sierra Wireless website.	

Table 8-1: LED indicator lights			
LED	Color / Pattern	Description	LED Power Saving Mode
Activity	Flashing Green	Traffic is being transmitted or received over the WAN interface.	
	Flashing Red	Traffic is being transmitted or received over the serial port. This behavior only appears if the RV50(X) is configured to display it. For more information, refer to the ALEOS Software Configuration Guide (Serial chapter) from the Sierra Wireless website.	
	Flashing Amber	Traffic is being transmitted or received over both the WAN interface and the serial port. This behavior only appears if the RV50(X) is configured to display it. Refer to the ALEOS Software Configuration Guide (Serial chapter) from the Sierra Wireless website.	
ALL	Green LED chase	Radio module reconfiguration/firmware update or Network Operator Switching is in progress.	
	Amber LED chase	Firmware update is in progress.	
	Solid Amber	Firmware update complete (all LEDs are amber except the Power LED)	
	Red LED chase	The modem is in Recovery mode.	

## 8.3 Signal strength and quality

Both signal strength and quality contribute to successful cellular data communications. The factors that influence signal strength and quality include but are not limited to:

- proximity to the cellular tower
- tower load
- competing signals
- physical barriers (mountains, buildings, vegetation)
- weather

Because signal strength and quality can vary due to many factors, they may not give a true indication of communications performance or range. However, they can be useful for activities such as:

- determining the optimal direction to aim a Yagi antenna
- determining the effects of antenna height and location
- trying alternate Yagi antenna (reflective) paths
- seeing the effect of vegetation and weather over time

### 8.3.1 Signal strength

Signal strength is how strong the received signal is. The closer your RV50(X) is to the cellular tower, the more signal the antenna will pick up. Signal strengths are lower the farther away from the tower the RV50(X) is.

For 3G networks, signal strength is reported as RSSI (Received Signal Strength Indicator). For 4G, it is RSRP (Reference Signal Received Power).

Signal strength units are  $-dBm$ ;  $-70$  is a stronger signal than  $-100$ .

- $-78$ : good
- $-78$  to  $-93$ : fair
- $-94$  to  $-102$ : poor
- less than  $-103$ : inadequate

### 8.3.2 Signal quality

Signal quality shows how much interference there is between the cellular tower and RV50(X), or how noisy a band is. Cellular signal noise comes from reflections, ghosting and other interference. Better signal quality is an indicator of more successful communications during precipitation events such as rain and snow.

For 3G networks, signal quality is ECIO (Energy to Interference Ratio). For 4G, this is RSRQ (Reference Signal Received Quality).

Signal quality units are  $-dBm$ ;  $0$  is a better signal than  $-10$ .

Find your module signal strength and quality through *ACEmanager*. Click **Status** > **Cellular** and look for **Signal Strength (RSSI)** and **Signal Quality (RSRQ)**.



mode.Recovery mode enables you to update the RV50(X) firmware and return it to working order.

To enter Recovery mode manually:

- Press the **Reset** button for more than 20 seconds. (Release the button when the Power LED flashes amber.)

To recover the router:

- Update the firmware using the Recovery mode interface. Once the new version is successfully uploaded and installed, the RV50(X) will reboot and exit Recovery mode. When the process is complete, the *ACEmanager* login screen will appear.

**NOTE:**

Reload the RV50(X) firmware and templates after the Recovery.

To exit Recovery mode, if it has been inadvertently entered, do one of the following:

- Press the RV50(X) **Reset** button.
- Click **Reboot** on the *ACEmanager* Recovery screen.
- Wait 10 minutes. If no action is taken within 10 minutes of the module entering Recovery mode (for example, if the Recovery screen has not been loaded by the web browser), it automatically reboots and exits Recovery mode.

## 9. Attributions

---

AirLink and Sierra Wireless are registered trademarks of Sierra Wireless.

AT&T is a trademark of AT&T Intellectual Property.

Bell is a registered trademark of Bell Canada.

PakBus is a registered trademark of Campbell Scientific, Inc.

Rogers is a trademark of Rogers Communications.

Sprint is a registered trademark of Sprint.

T-Mobile is a registered trademark of Deutsche Telekom AG.

Telus is a registered trademark of Telus Corporation.

Verizon is a registered trademark of Verizon.

All other trademarks or registered trademarks are the property of their respective owners.

# Appendix A. *ACEManager* and template files

---

*ACEManager* along with template files can be used to set up the RV50(X) in PPP or serial server mode. To enable PPP mode, see [Enabling PPP mode](#) (p. 14).

*ACEManager* is accessed via a web browser. For initial setup or troubleshooting with a direct (cabled) connection, connect a standard Ethernet (RJ45) cable between the Ethernet port on the computer and that on the module. Type **https://192.168.13.31:9443** into a web browser.

## NOTE:

RV50(X)s running OS version 4.13 and older had both HTTP port 9191 and HTTPS port 9443 enabled by default. When using HTTP (not HTTPS) with these older OS versions, enter the IP address using port number 9191, for example, <http://192.168.13.31:9191>.

Once the module is provisioned on the network, it may be accessed over the air by typing **https://** followed by the IP address of the module, followed by the port **:9443**.

The first screen is a login (shown below). Look for a sticker on the bottom of your modem with the manufacturer-generated default password. Log in using **User Name** = user and that **Password**. If there is no sticker try 12345 for the password. Make note of the password used so it can be easily referenced when off site. Remote access to the modem interface will require the password.

## TIP:

We strongly recommend changing the default password to prevent unauthorized access and the potential of malware infection. The password can be changed from the **Admin** tab.

## WARNING:

Failure to set a strong password in the RV50(X) may result in misuse of the modem by malware or hackers. Significant data overage charges may apply.

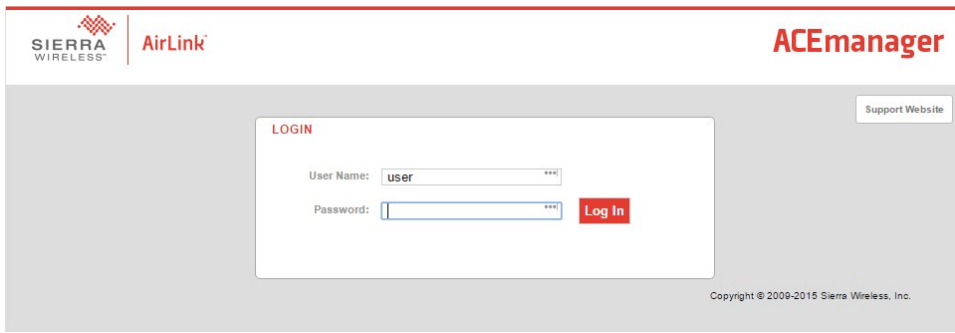

After entering the password and pressing enter (or clicking **Log In**), the following status screen is displayed:

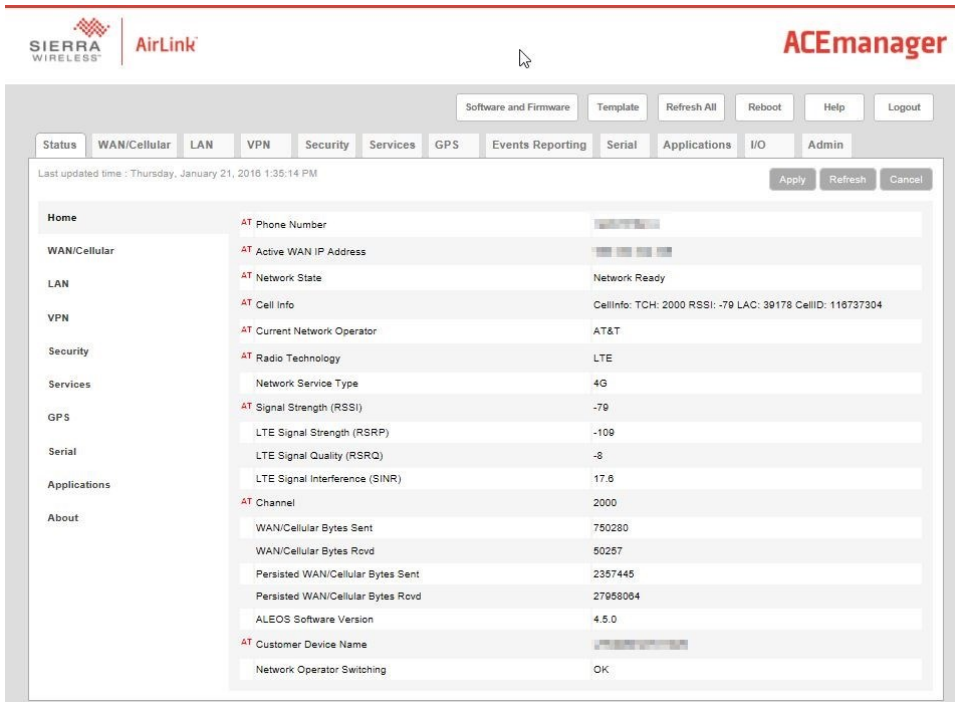

RV50 template files from the Campbell Scientific website ([www.campbellsci.com/downloads](http://www.campbellsci.com/downloads)) are used to configure the RV50(X) module using *ACEmanager*.

Template Files	
Template File Name	Description
RV50_115200.xml	Default configuration with RS-232 at 115200 baud and Ethernet communication enabled. <sup>1</sup>
RV50_9600.xml	Default configuration with RS-232 at 9600 baud and Ethernet communication enabled. <sup>2</sup>
<sup>1</sup> CR1000X series, CR300 series, CR6 series, CR1000, CR3000, CR800 series, CR5000, and GRANITE 6/9/10 <sup>2</sup> CR10X, CR10X-PB, CR510, CR510-PB, CR23X, CR23X-PB, and CR200(X) series data loggers	

Click the **Template** menu in the top right of the screen. When prompted for a template file name, select **RV50\_115200.xml** or **RV50\_9600.xml**. The following screen shows the settings under the **Serial** tab after the 115200 baud template file has been loaded.

The screenshot shows the ACEmanager interface with the **Serial** tab selected. The page title is "Port Configuration" and it includes a "MODBUS Address List" section. The main configuration area is titled "LED Indicator" and contains the following settings:

Serial Port	Enable
AT Startup Mode Default	Normal (AT command)
AT Configure Serial Port	115200,8N1
AT Flow Control	None
AT DB9 Serial Echo	Enable
AT Data Forwarding Timeout (.1 second)	1
AT Data Forwarding Character	0
AT Device Port	3001
AT Serial MTU	1304
AT Destination Port	0
AT Destination Address	0.0.0.0
AT Default Dial Mode	UDP
Host Authentication Mode	NONE
PPP User ID	
PPP Password	
[+] Advanced	
AT Assert DSR	In Data Mode
AT Assert DCD	In Data Mode
AT DTR Mode	Ignore DTR
AT Quiet Mode	Disable
AT AT Verbose Mode	Verbose

Click on **WAN/Cellular** for the following screen:

The screenshot shows the ACEmanager interface with the **WAN/Cellular** tab selected. The page title is "WAN/Cellular" and it includes a "SIM Slot 1 Configuration" section. The main configuration area is titled "Network Credentials" and contains the following settings:

APN in Use	I2GOLD
AT User Entered APN	I2GOLD
AT SIM PIN	SIM PIN
[+] Advanced	
[+] APN Backup	

Enter the APN as shown in the screen above. The example is for an **APN = I2GOLD**.

After the template file has been loaded, and the APN entered, click **Apply** to save the changes in the module.



Click **Reboot** to restart the module. Alternately, reset the module by pressing **Reset** on the front of the module or by removing power from the module.

Click **Logout** to terminate communications with the module.

**WARNING:**

Unless you Apply the commands, the changes made will not be saved in the module. For most commands, you must reboot the module for the newly written values to take effect.

The module is now set up for PPP or serial server mode.

## A.1 Additional security (optional but recommended)

To prevent unwanted data usage when using a public static IP, consider doing the following:

- Limit open ports – Limit the number of configured ports that the RV50(X) is listening on. Open ports increase the chance of unwanted exploitation resulting in higher data usage and possible equipment misuse.

The *ACEManager* template provided by Campbell Scientific limits these ports for you. Only the ports needed for communications with your data logger are opened. It is important to load the template prior to adding or deleting any additional ports.

- Set Trusted IPs – The RV50(X) Trusted IP list limits devices that the RV50(X) will respond to. This requires entering the public IP address of each computer that will connect with or through the RV50(X). Each computer must have an unchanging public IP address set in *ACEManager* on the **Security** tab in the **Trusted IPs - Inbound (Friends)** field.

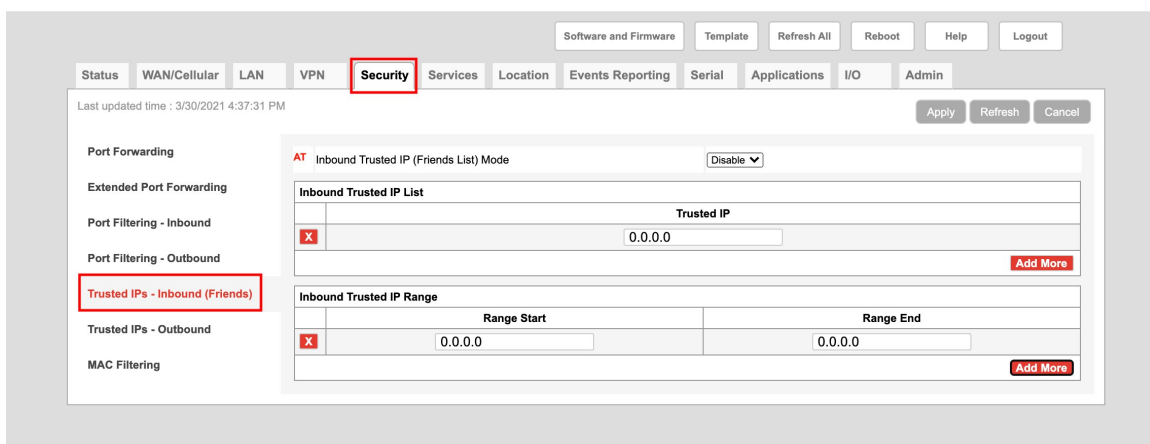

**CAUTION:**

Only set a Trusted IP address if you are familiar with the use of IP addresses. Consult your IT department or Campbell Scientific for assistance.

**NOTE:**

This setting does not affect outbound connections, only incoming connections.

# Appendix B. Controlling power to the RV50(X)

The RV50 uses considerably more power than the data logger. Therefore, it may be necessary to use the data logger to control power to the RV50. The following program examples show how to control power to the RV50 using the switched 12V (**SW12V**) terminal on the data logger.

This example shows how to control power to the RV50 by using the CRBasic [TimeIsBetween\(\)](#) instruction to turn on **SW12** for 15 minutes every 60 minutes between 9:00 a.m. and 5:00 p.m.

## NOTE:

[TimeIsBetween\(\)](#) requires operating system version 28.00 or greater in the CR1000, CR3000, or CR800. It is supported in all CR1000X, CR6, and CR300 operating systems.

### CRBasic Example 1: Turn RV50(X) ON and OFF under data logger control

```
'Declare Variables and Units
Public BattV
Public PTemp_C
Public ModuleState As Boolean

Units BattV=Volts
Units PTemp_C=Deg C

'Define Data Tables
DataTable(Daily,True,-1)
  DataInterval(0,1440,Min,10)
  Minimum(1,BattV,FP2,False,False)
EndTable

'Main Program
BeginProg
  'Main Scan
  Scan(5,Sec,1,0)
  'Default Data Logger Battery Voltage measurement 'BattV'
  Battery(BattV)
  'Default Wiring Panel Temperature measurement 'PTemp_C'
  PanelTemp(PTemp_C,60)
  'Between the hours of 9:00 and 17:00, turn the RV50(X)
  'on for 15 minutes at the start of every hour
  If TimeIsBetween(9,17,24,Hr) AND TimeIsBetween(0,15,60,Min) Then
    ModuleState=True
```

## CRBasic Example 1: Turn RV50(X) ON and OFF under data logger control

```
    PPPOpen
    SW12(1)
Else
    ModuleState=False
    PPPClose
    SW12(0)
EndIf
'Always turn OFF RV50(X) if battery drops below 11.5 volts
If BattV<11.5 Then
    'Set RV50(X) power to the state of 'ModuleState' variable
    SW12(0)
EndIf
'Call Data Tables and Store Data
CallTable Daily
NextScan
EndProg
```

# Appendix C. Using the RV50(X) Ethernet port

The RV50(X) **Ethernet** port can be used to communicate with IP-enabled devices such as data loggers and IP cameras. However, the use of Ethernet communication increases the total system current demand (the module and the device you are connecting to) by several milliamps as compared to the use of serial communications.

The following example can be used to communicate with a CR1000 / NL121 via the RV50(X) **Ethernet** port. Port forwarding in the RV50(X) must be enabled and specific ports need to be forwarded to the CR1000 (in this case ports 80 and 6785). Additional ports can be configured as needed. The host IP address 192.168.13.50 specified in the figure below is the IP address of the CR1000.

The screenshot shows the ACEmanager web interface for configuring port forwarding. The interface includes a navigation menu with tabs for Status, WAN/Cellular, LAN, VPN, Security, Services, GPS, Events Reporting, Serial, Applications, I/O, and Admin. The Security tab is selected. The Port Forwarding section is active, showing DMZ Enabled (Automatic), DMZ IP in use (192.168.13.100), and Port Forwarding (Enable). A table lists two port forwarding rules:

	Public Start Port	Public End Port	Protocol	Host IP	Private Start Port
Trusted IPs - Inbound (Friends)	80	0	TCP	192.168.13.50	80
Trusted IPs - Outbound	6785	0	TCP	192.168.13.50	6785

The table also includes an 'Add More' button at the bottom right.

For this example, a static **Ethernet IP Address**, **Default Gateway**, **Ethernet Subnet Mask**, and **Ethernet Name Servers** are configured in the CR1000 as shown in the figure below. The example CR1000 Ethernet IP address of 192.168.13.50 is the same address used in the RV50(X) port forwarding configured previously.

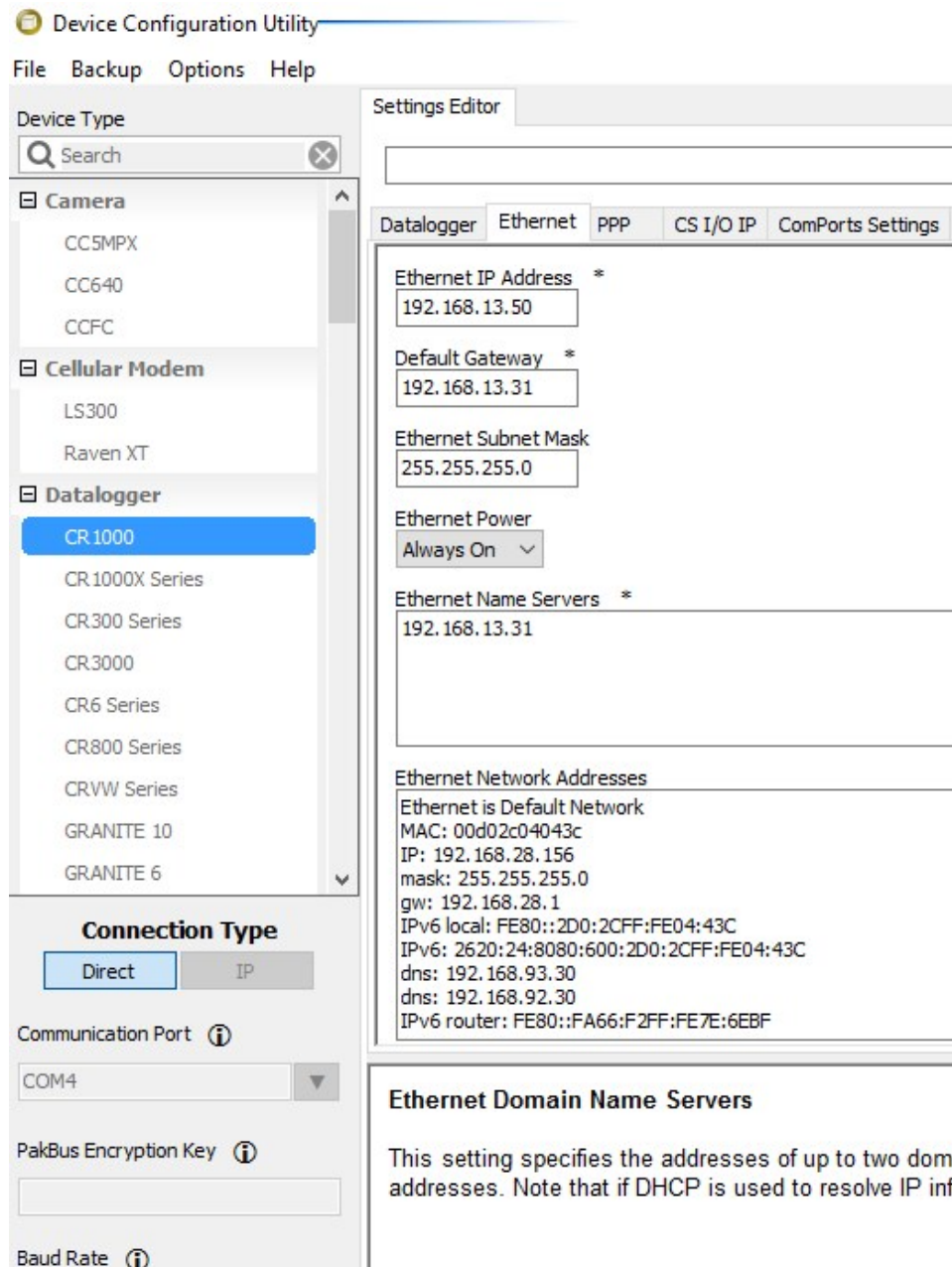

Once the RV50(X) and the CR1000 have been configured and the RV50(X) has been rebooted, you can communicate with the CR1000 via LoggerNet using the public IP address of the RV50(X) and port 6785. You can also open a web browser and enter the public IP address of the RV50(X) to see the default web page of the CR1000.

# Appendix D. Verizon Wireless and AT&T

---

## NOTE:

Campbell Scientific can provide Verizon Wireless or AT&T service. This is the simplest way to set up your module on the Verizon Wireless or AT&T network. See [Campbell Scientific cellular data service](#) (p. 4).

## D.1 Verizon Wireless

What you need:

- Verizon Wireless 4G LTE CAT-1 coverage at the data logger site. For a coverage map, refer to: [www.verizonwireless.com/landingpages/better-matters/#maps](http://www.verizonwireless.com/landingpages/better-matters/#maps) 
- Verizon Wireless 4G LTE private dynamic IP account in conjunction with Campbell Scientific Konect PakBus Router Service. (A Verizon Wireless 4G LTE static unrestricted IP account can also be used. However, Verizon generally requires new users to have 50 lines of service to obtain the static unrestricted IP account. Also, there is generally a \$500 one-time-per-customer charge to activate static IP on the account.)

To set up an account, you will need the IMEI number of the module. The IMEI number is listed on a label on the module. To set up an account with Verizon Wireless, call:

800-526-3178 for Business Sales

800-256-4646 for Personal Sales

Verizon Wireless will provide a SIM (Subscriber Identity Module) card for each module. The Mini-SIM (2FF) card must be installed inside of the module as described in [Install the SIM card](#) (p. 5). In addition to the SIM card, you should receive:

- 10-digit MSISDN number (telephone number associated with the SIM, used for billing)
- An APN (Access Point Name) for 4G LTE CAT-1 service. A common APN used for this application is: VZWINTERNET. The user must program the APN into the module.
- For static IP accounts only, an IP Address will be included.

## D.2 AT&T

What you need:

- AT&T 4G LTE CAT-1 coverage at the data logger site. For a coverage map refer to: [www.att.com/maps/wireless-coverage.html](http://www.att.com/maps/wireless-coverage.html) .
- AT&T 4G LTE private dynamic IP account in conjunction with Campbell Scientific's Konect Router Service. (An AT&T 4G LTE static unrestricted IP account can also be used. However, AT&T charges \$3/month/device for the static IP account.)

To set up an AT&T account, contact your AT&T Business Account Representative or Blu-Telecommunications.

Blu-Telecommunications is part of the Alliance Channel with AT&T and can assist any customer nationwide. Blu-Telecommunications will contact AT&T and work with an AT&T account manager to set up an account.

Contact information for Blu-Telecommunication:

Website: [www.blu-tel.com](http://www.blu-tel.com) 

Phone number: (877) 422-2616, or Email box: [i2gold@blu-tel.com](mailto:i2gold@blu-tel.com)

What to ask for: M2M Setup

Who to ask for: Carlos Morales or Andy Tran

An APN (Access Point Name) must be added onto the account to make the module accessible through the Internet. For networks with fewer than 30 modules, the standard 'I2Gold APN' can be used; networks with more than 30 modules will require a 'Custom APN'. A Custom APN has a setup fee starting at \$500 and takes a minimum of 7 to 14 business days to complete. The user must program the APN into the module.

AT&T will provide a Subscriber Identity Module (SIM) card for each module. The Mini-SIM (2FF) card must be installed inside of the module as described in [Install the SIM card](#) (p. 5). In addition to the SIM card, you should receive:

- 10-digit MSISDN number (telephone number associated with the SIM, used for billing)
- An APN (Access Point Name) for 4G LTE CAT-1 service. A common APN used for this application is: BROADBAND. The user must program the APN into the module.
- For static IP accounts only, an IP Address will be included.



# Appendix E. Regulatory information

---

This information provided by Sierra Wireless®.

## E.1 Important information for North American users

This equipment has been tested and found to comply with the limits for a Class A digital device, pursuant to part 15 of the FCC Rules. These limits are designed to provide reasonable protection against harmful interference when the equipment is operated in a commercial environment. This equipment generates, uses, and can radiate radio frequency energy and, if not installed and used in accordance with the instruction manual, may cause harmful interference to radio communications. Operation of this equipment in a residential area is likely to cause harmful interference, in which case the user will be required to correct the interference at his own expense.

Changes or modifications to this device not expressly approved by Sierra Wireless could void the user's authority to operate this equipment.

## E.2 RF exposure

In accordance with FCC/IC requirements of human exposure to radio frequency fields, the radiating element shall be installed such that a minimum separation distance of 20 cm should be maintained from the antenna and the user's body.

This product is only to be installed by qualified personnel.

To comply with FCC/IC regulations limiting both maximum RF output power and human exposure to RF radiation, the maximum antenna gain must not exceed the specifications listed below for the device used.

Device	Frequency Band	Gain
AirLink RV50 (N7NMC7355 2417C-MC7355)	Cellular Band	4.0 dBi
	PCS Band	3.0 dBi
	Band 2	3.0 dBi
	Band 4	4.0 dBi
	Band 13	4.0 dBi
	Band 17	4.0 dBi
	Band 25	3.0 dBi
AirLink RV50(X) (N7NMC7455 2417C-MC7455)	Bands 2, 4, 5, 12, 13, 25, 26	6.0 dBi
	Band 7, 41	9.0 dBi

## E.3 EU

Sierra Wireless hereby declares the AirLink RV50(X) devices is in compliance with the essential requirements and other relevant provisions of Directive 1999/5/EC.

The RV50(X) displays the CE mark.



Changes or modifications to this device not expressly approved by Sierra Wireless could void the user's authority to operate this equipment.

This product is only to be installed by qualified personnel.

## E.4 Declaration of conformity

The Declaration of Conformity made under Directive 1999/5/EC is available for viewing at:

RV50X: [https://source.sierrawireless.com/resources/airlink/certification\\_and\\_type\\_approval/rv50x\\_ce\\_declaration\\_of\\_conformity/](https://source.sierrawireless.com/resources/airlink/certification_and_type_approval/rv50x_ce_declaration_of_conformity/)

RV50: [http://source.sierrawireless.com/resources/airlink/-certification\\_and\\_type\\_approval/rv50\\_ce\\_declaration\\_of\\_conformity/](http://source.sierrawireless.com/resources/airlink/-certification_and_type_approval/rv50_ce_declaration_of_conformity/)

# E.5 RoHS compliance



Sierra Wireless SA  
24 Boulevard des Îles  
92130 Issy-les-Moulineaux  
France  
Phone +33(0) 1 46 29 08 00  
www.sierrawireless.com

## DECLARATION OF EUROPEAN UNION RoHS COMPLIANT PRODUCT

Sierra Wireless S.A. for itself and its subsidiaries (collectively, "Sierra Wireless") certifies that to the best of its knowledge the products identified below to be "RoHS Compliant":

Item	Product Description
1	RV50
2	RV50x
3	ACCESSORY, RV50, DIN MOUNT BRACKET

RoHS compliant defines that the product conforms to the requirements of the European Union's on the restriction of the use of certain hazardous substances in electrical and electronics equipments directive, 2011/65/EU ("RoHS directive"), including directive 2015/863 amending annex II. The RoHS directive is with respect to any homogenous components used in the product as shipped by Sierra Wireless, in its entirety.

### **ROHS - Exemptions according to annex III**

- No exemption
- Exemption 6(b): Lead as an alloying element in aluminum containing up to 0.4 % lead by weight
- Exemption 6(c): Copper alloy containing up to 4 % lead by weight
- Exemption 7(a): Lead in high melting temperature type solder (ie lead-based alloys containing 85% by weight or more lead)
- Exemption 7(c)-I: Electrical and electronic components containing lead in a glass or ceramic other than dielectric ceramic in capacitors, eg piezoelectric devices, or in a glass or ceramic matrix compound
- Exemption 7(c)-II: Lead in dielectric ceramic in capacitors for a rated voltage of 125 V AC or 250 V DC or higher
- Exemption 15: Lead in solders to complete a viable electrical connection between semiconductor die and carrier with integrated circuit flip chip packages.
- Other exemption than above.

Sierra Wireless has reach its conclusion that the products listed above are RoHS compliant based on its knowledge and belief via internal design controls, analytical test data and information provided by its component suppliers. However, Sierra Wireless makes no representation or warranty as to the accuracy of such third party information.

Sierra Wireless, S.A.

Name: Rafet Lakhdar  
Title: Director Global Customer Quality  
Date: January 10th, 2018

# Limited warranty

---

Products manufactured by Campbell Scientific are warranted by Campbell Scientific to be free from defects in materials and workmanship under normal use and service for twelve months from the date of shipment unless otherwise specified on the corresponding product webpage. See Product Details on the Ordering Information pages at [www.campbellsci.com](http://www.campbellsci.com)<sup>↗</sup>. Other manufacturer's products, that are resold by Campbell Scientific, are warranted only to the limits extended by the original manufacturer.

Refer to [www.campbellsci.com/terms#warranty](http://www.campbellsci.com/terms#warranty)<sup>↗</sup> for more information.

**CAMPBELL SCIENTIFIC EXPRESSLY DISCLAIMS AND EXCLUDES ANY IMPLIED WARRANTIES OF MERCHANTABILITY OR FITNESS FOR A PARTICULAR PURPOSE.** Campbell Scientific hereby disclaims, to the fullest extent allowed by applicable law, any and all warranties and conditions with respect to the Products, whether express, implied or statutory, other than those expressly provided herein.

# Assistance

---

Products may not be returned without prior authorization.

Products shipped to Campbell Scientific require a Returned Materials Authorization (RMA) or Repair Reference number and must be clean and uncontaminated by harmful substances, such as hazardous materials, chemicals, insects, and pests. Please complete the required forms prior to shipping equipment.

Campbell Scientific regional offices handle repairs for customers within their territories. Please see the back page for the Global Sales and Support Network or visit [www.campbellsci.com/contact](http://www.campbellsci.com/contact)  to determine which Campbell Scientific office serves your country.

To obtain a Returned Materials Authorization or Repair Reference number, contact your CAMPBELL SCIENTIFIC regional office. Please write the issued number clearly on the outside of the shipping container and ship as directed.

For all returns, the customer must provide a "Statement of Product Cleanliness and Decontamination" or "Declaration of Hazardous Material and Decontamination" form and comply with the requirements specified in it. The form is available from your CAMPBELL SCIENTIFIC regional office. Campbell Scientific is unable to process any returns until we receive this statement. If the statement is not received within three days of product receipt or is incomplete, the product will be returned to the customer at the customer's expense. Campbell Scientific reserves the right to refuse service on products that were exposed to contaminants that may cause health or safety concerns for our employees.

# Safety

---

**DANGER** — MANY HAZARDS ARE ASSOCIATED WITH INSTALLING, USING, MAINTAINING, AND WORKING ON OR AROUND **TRIPODS, TOWERS, AND ANY ATTACHMENTS TO TRIPODS AND TOWERS SUCH AS SENSORS, CROSSARMS, ENCLOSURES, ANTENNAS, ETC.** FAILURE TO PROPERLY AND COMPLETELY ASSEMBLE, INSTALL, OPERATE, USE, AND MAINTAIN TRIPODS, TOWERS, AND ATTACHMENTS, AND FAILURE TO HEED WARNINGS, INCREASES THE RISK OF DEATH, ACCIDENT, SERIOUS INJURY, PROPERTY DAMAGE, AND PRODUCT FAILURE. TAKE ALL REASONABLE PRECAUTIONS TO AVOID THESE HAZARDS. CHECK WITH YOUR ORGANIZATION'S SAFETY COORDINATOR (OR POLICY) FOR PROCEDURES AND REQUIRED PROTECTIVE EQUIPMENT PRIOR TO PERFORMING ANY WORK.

Use tripods, towers, and attachments to tripods and towers only for purposes for which they are designed. Do not exceed design limits. Be familiar and comply with all instructions provided in product manuals. Manuals are available at [www.campbellsci.com](http://www.campbellsci.com). You are responsible for conformance with governing codes and regulations, including safety regulations, and the integrity and location of structures or land to which towers, tripods, and any attachments are attached. Installation sites should be evaluated and approved by a qualified engineer. If questions or concerns arise regarding installation, use, or maintenance of tripods, towers, attachments, or electrical connections, consult with a licensed and qualified engineer or electrician.

## General

- Protect from over-voltage.
- Protect electrical equipment from water.
- Protect from electrostatic discharge (ESD).
- Protect from lightning.
- Prior to performing site or installation work, obtain required approvals and permits. Comply with all governing structure-height regulations.
- Use only qualified personnel for installation, use, and maintenance of tripods and towers, and any attachments to tripods and towers. The use of licensed and qualified contractors is highly recommended.
- Read all applicable instructions carefully and understand procedures thoroughly before beginning work.
- Wear a **hardhat** and **eye protection**, and take **other appropriate safety precautions** while working on or around tripods and towers.
- **Do not climb** tripods or towers at any time, and prohibit climbing by other persons. Take reasonable precautions to secure tripod and tower sites from trespassers.
- Use only manufacturer recommended parts, materials, and tools.

## Utility and Electrical

- **You can be killed** or sustain serious bodily injury if the tripod, tower, or attachments you are installing, constructing, using, or maintaining, or a tool, stake, or anchor, come in **contact with overhead or underground utility lines**.
- Maintain a distance of at least one-and-one-half times structure height, 6 meters (20 feet), or the distance required by applicable law, **whichever is greater**, between overhead utility lines and the structure (tripod, tower, attachments, or tools).
- Prior to performing site or installation work, inform all utility companies and have all underground utilities marked.
- Comply with all electrical codes. Electrical equipment and related grounding devices should be installed by a licensed and qualified electrician.
- Only use power sources approved for use in the country of installation to power Campbell Scientific devices.

## Elevated Work and Weather

- Exercise extreme caution when performing elevated work.
- Use appropriate equipment and safety practices.
- During installation and maintenance, keep tower and tripod sites clear of un-trained or non-essential personnel. Take precautions to prevent elevated tools and objects from dropping.
- Do not perform any work in inclement weather, including wind, rain, snow, lightning, etc.

## Maintenance

- Periodically (at least yearly) check for wear and damage, including corrosion, stress cracks, frayed cables, loose cable clamps, cable tightness, etc. and take necessary corrective actions.
- Periodically (at least yearly) check electrical ground connections.

## Internal Battery

- Be aware of fire, explosion, and severe-burn hazards.
- Misuse or improper installation of the internal lithium battery can cause severe injury.
- Do not recharge, disassemble, heat above 100 °C (212 °F), solder directly to the cell, incinerate, or expose contents to water. Dispose of spent batteries properly.

WHILE EVERY ATTEMPT IS MADE TO EMBODY THE HIGHEST DEGREE OF SAFETY IN ALL CAMPBELL SCIENTIFIC PRODUCTS, THE CUSTOMER ASSUMES ALL RISK FROM ANY INJURY RESULTING FROM IMPROPER INSTALLATION, USE, OR MAINTENANCE OF TRIPODS, TOWERS, OR ATTACHMENTS TO TRIPODS AND TOWERS SUCH AS SENSORS, CROSSARMS, ENCLOSURES, ANTENNAS, ETC.



## Global Sales & Support Network

A worldwide network to help meet your needs



### Campbell Scientific regional offices

#### Australia

**Location:** Garbutt, QLD Australia  
**Phone:** 61.7.4401.7700  
**Email:** [info@campbellsci.com.au](mailto:info@campbellsci.com.au)  
**Website:** [www.campbellsci.com.au](http://www.campbellsci.com.au)

#### Brazil

**Location:** São Paulo, SP Brazil  
**Phone:** 11.3732.3399  
**Email:** [vendas@campbellsci.com.br](mailto:vendas@campbellsci.com.br)  
**Website:** [www.campbellsci.com.br](http://www.campbellsci.com.br)

#### Canada

**Location:** Edmonton, AB Canada  
**Phone:** 780.454.2505  
**Email:** [dataloggers@campbellsci.ca](mailto:dataloggers@campbellsci.ca)  
**Website:** [www.campbellsci.ca](http://www.campbellsci.ca)

#### China

**Location:** Beijing, P. R. China  
**Phone:** 86.10.6561.0080  
**Email:** [info@campbellsci.com.cn](mailto:info@campbellsci.com.cn)  
**Website:** [www.campbellsci.com.cn](http://www.campbellsci.com.cn)

#### Costa Rica

**Location:** San Pedro, Costa Rica  
**Phone:** 506.2280.1564  
**Email:** [info@campbellsci.com](mailto:info@campbellsci.com)  
**Website:** [www.campbellsci.com](http://www.campbellsci.com)

#### France

**Location:** Vincennes, France  
**Phone:** 0033.0.1.56.45.15.20  
**Email:** [info@campbellsci.fr](mailto:info@campbellsci.fr)  
**Website:** [www.campbellsci.fr](http://www.campbellsci.fr)

#### Germany

**Location:** Bremen, Germany  
**Phone:** 49.0.421.460974.0  
**Email:** [info@campbellsci.de](mailto:info@campbellsci.de)  
**Website:** [www.campbellsci.de](http://www.campbellsci.de)

#### India

**Location:** New Delhi, DL India  
**Phone:** 91.11.46500481.482  
**Email:** [info@campbellsci.in](mailto:info@campbellsci.in)  
**Website:** [www.campbellsci.in](http://www.campbellsci.in)

#### South Africa

**Location:** Stellenbosch, South Africa  
**Phone:** 27.21.8809960  
**Email:** [sales@campbellsci.co.za](mailto:sales@campbellsci.co.za)  
**Website:** [www.campbellsci.co.za](http://www.campbellsci.co.za)

#### Spain

**Location:** Barcelona, Spain  
**Phone:** 34.93.2323938  
**Email:** [info@campbellsci.es](mailto:info@campbellsci.es)  
**Website:** [www.campbellsci.es](http://www.campbellsci.es)

#### Thailand

**Location:** Bangkok, Thailand  
**Phone:** 66.2.719.3399  
**Email:** [info@campbellsci.asia](mailto:info@campbellsci.asia)  
**Website:** [www.campbellsci.asia](http://www.campbellsci.asia)

#### UK

**Location:** Shepshed, Loughborough, UK  
**Phone:** 44.0.1509.601141  
**Email:** [sales@campbellsci.co.uk](mailto:sales@campbellsci.co.uk)  
**Website:** [www.campbellsci.co.uk](http://www.campbellsci.co.uk)

#### USA

**Location:** Logan, UT USA  
**Phone:** 435.227.9120  
**Email:** [info@campbellsci.com](mailto:info@campbellsci.com)  
**Website:** [www.campbellsci.com](http://www.campbellsci.com)