

# OPERATOR'S MANUAL



## **OBS500 Smart Turbidity Meter** **with ClearSensor® Technology**

Revision: 1/16



Copyright © 2008-2016  
Campbell Scientific, Inc.



# Guarantee

---

This equipment is guaranteed against defects in materials and workmanship. We will repair or replace products which prove to be defective during the guarantee period as detailed on your invoice, provided they are returned to us prepaid. The guarantee will not apply to:

- Equipment which has been modified or altered in any way without the written permission of Campbell Scientific
- Batteries
- Any product which has been subjected to misuse, neglect, acts of God or damage in transit.

Campbell Scientific will return guaranteed equipment by surface carrier prepaid. Campbell Scientific will not reimburse the claimant for costs incurred in removing and/or reinstalling equipment. This guarantee and the Company's obligation thereunder is in lieu of all other guarantees, expressed or implied, including those of suitability and fitness for a particular purpose. Campbell Scientific is not liable for consequential damage.

Please inform us before returning equipment and obtain a Repair Reference Number whether the repair is under guarantee or not. Please state the faults as clearly as possible, and if the product is out of the guarantee period it should be accompanied by a purchase order. Quotations for repairs can be given on request. It is the policy of Campbell Scientific to protect the health of its employees and provide a safe working environment, in support of this policy a "Declaration of Hazardous Material and Decontamination" form will be issued for completion.

When returning equipment, the Repair Reference Number must be clearly marked on the outside of the package. Complete the "Declaration of Hazardous Material and Decontamination" form and ensure a completed copy is returned with your goods. Please note your Repair may not be processed if you do not include a copy of this form and Campbell Scientific Ltd reserves the right to return goods at the customers' expense.

Note that goods sent air freight are subject to Customs clearance fees which Campbell Scientific will charge to customers. In many cases, these charges are greater than the cost of the repair.



Campbell Scientific Ltd,  
80 Hathern Road,  
Shepshed, Loughborough, LE12 9GX, UK  
Tel: +44 (0) 1509 601141  
Fax: +44 (0) 1509 601091  
Email: [support@campbellsci.co.uk](mailto:support@campbellsci.co.uk)  
[www.campbellsci.co.uk](http://www.campbellsci.co.uk)

# PLEASE READ FIRST

---

## About this manual

Please note that this manual was originally produced by Campbell Scientific Inc. primarily for the North American market. Some spellings, weights and measures may reflect this origin.

Some useful conversion factors:

<b>Area:</b> 1 in <sup>2</sup> (square inch) = 645 mm <sup>2</sup>	<b>Mass:</b> 1 oz. (ounce) = 28.35 g 1 lb (pound weight) = 0.454 kg
<b>Length:</b> 1 in. (inch) = 25.4 mm 1 ft (foot) = 304.8 mm 1 yard = 0.914 m 1 mile = 1.609 km	<b>Pressure:</b> 1 psi (lb/in <sup>2</sup> ) = 68.95 mb
	<b>Volume:</b> 1 UK pint = 568.3 ml 1 UK gallon = 4.546 litres 1 US gallon = 3.785 litres

In addition, while most of the information in the manual is correct for all countries, certain information is specific to the North American market and so may not be applicable to European users.

Differences include the U.S standard external power supply details where some information (for example the AC transformer input voltage) will not be applicable for British/European use. *Please note, however, that when a power supply adapter is ordered it will be suitable for use in your country.*

Reference to some radio transmitters, digital cell phones and aerials may also not be applicable according to your locality.

Some brackets, shields and enclosure options, including wiring, are not sold as standard items in the European market; in some cases alternatives are offered. Details of the alternatives will be covered in separate manuals.

Part numbers prefixed with a “#” symbol are special order parts for use with non-EU variants or for special installations. Please quote the full part number with the # when ordering.

## Recycling information



At the end of this product's life it should not be put in commercial or domestic refuse but sent for recycling. Any batteries contained within the product or used during the products life should be removed from the product and also be sent to an appropriate recycling facility.

Campbell Scientific Ltd can advise on the recycling of the equipment and in some cases arrange collection and the correct disposal of it, although charges may apply for some items or territories.

For further advice or support, please contact Campbell Scientific Ltd, or your local agent.



Campbell Scientific Ltd, 80 Hathern Road, Shepshed, Loughborough, LE12 9GX, UK  
Tel: +44 (0) 1509 601141 Fax: +44 (0) 1509 601091  
Email: [support@campbellsci.co.uk](mailto:support@campbellsci.co.uk)  
[www.campbellsci.co.uk](http://www.campbellsci.co.uk)

# Precautions

---

DANGER — MANY HAZARDS ARE ASSOCIATED WITH INSTALLING, USING, MAINTAINING, AND WORKING ON OR AROUND **TRIPODS, TOWERS, AND ANY ATTACHMENTS TO TRIPODS AND TOWERS SUCH AS SENSORS, CROSSARMS, ENCLOSURES, ANTENNAS, ETC.** FAILURE TO PROPERLY AND COMPLETELY ASSEMBLE, INSTALL, OPERATE, USE, AND MAINTAIN TRIPODS, TOWERS, AND ATTACHMENTS, AND FAILURE TO HEED WARNINGS, INCREASES THE RISK OF DEATH, ACCIDENT, SERIOUS INJURY, PROPERTY DAMAGE, AND PRODUCT FAILURE. TAKE ALL REASONABLE PRECAUTIONS TO AVOID THESE HAZARDS. CHECK WITH YOUR ORGANIZATION'S SAFETY COORDINATOR (OR POLICY) FOR PROCEDURES AND REQUIRED PROTECTIVE EQUIPMENT PRIOR TO PERFORMING ANY WORK.

Use tripods, towers, and attachments to tripods and towers only for purposes for which they are designed. Do not exceed design limits. Be familiar and comply with all instructions provided in product manuals. Manuals are available at [www.campbellsci.eu](http://www.campbellsci.eu) or by telephoning +44(0) 1509 828 888 (UK). You are responsible for conformance with governing codes and regulations, including safety regulations, and the integrity and location of structures or land to which towers, tripods, and any attachments are attached. Installation sites should be evaluated and approved by a qualified engineer. If questions or concerns arise regarding installation, use, or maintenance of tripods, towers, attachments, or electrical connections, consult with a licensed and qualified engineer or electrician.

## General

- Prior to performing site or installation work, obtain required approvals and permits. Comply with all governing structure-height regulations, such as those of the FAA in the USA.
- Use only qualified personnel for installation, use, and maintenance of tripods and towers, and any attachments to tripods and towers. The use of licensed and qualified contractors is highly recommended.
- Read all applicable instructions carefully and understand procedures thoroughly before beginning work.
- Wear a **hardhat** and **eye protection**, and take **other appropriate safety precautions** while working on or around tripods and towers.
- **Do not climb** tripods or towers at any time, and prohibit climbing by other persons. Take reasonable precautions to secure tripod and tower sites from trespassers.
- Use only manufacturer recommended parts, materials, and tools.

## Utility and Electrical

- **You can be killed** or sustain serious bodily injury if the tripod, tower, or attachments you are installing, constructing, using, or maintaining, or a tool, stake, or anchor, come in **contact with overhead or underground utility lines**.
- Maintain a distance of at least one-and-one-half times structure height, or 20 feet, or the distance required by applicable law, **whichever is greater**, between overhead utility lines and the structure (tripod, tower, attachments, or tools).
- Prior to performing site or installation work, inform all utility companies and have all underground utilities marked.
- Comply with all electrical codes. Electrical equipment and related grounding devices should be installed by a licensed and qualified electrician.

## Elevated Work and Weather

- Exercise extreme caution when performing elevated work.
- Use appropriate equipment and safety practices.
- During installation and maintenance, keep tower and tripod sites clear of un-trained or non-essential personnel. Take precautions to prevent elevated tools and objects from dropping.
- Do not perform any work in inclement weather, including wind, rain, snow, lightning, etc.

## Maintenance

- Periodically (at least yearly) check for wear and damage, including corrosion, stress cracks, frayed cables, loose cable clamps, cable tightness, etc. and take necessary corrective actions.
- Periodically (at least yearly) check electrical ground connections.

WHILE EVERY ATTEMPT IS MADE TO EMBODY THE HIGHEST DEGREE OF SAFETY IN ALL CAMPBELL SCIENTIFIC PRODUCTS, THE CUSTOMER ASSUMES ALL RISK FROM ANY INJURY RESULTING FROM IMPROPER INSTALLATION, USE, OR MAINTENANCE OF TRIPODS, TOWERS, OR ATTACHMENTS TO TRIPODS AND TOWERS SUCH AS SENSORS, CROSSARMS, ENCLOSURES, ANTENNAS, ETC.



# Table of Contents

---

PDF viewers: These page numbers refer to the printed version of this document. Use the PDF reader bookmarks tab for links to specific sections.

<b>1. Introduction .....</b>	<b>1</b>
<b>2. Precautions .....</b>	<b>1</b>
<b>3. Initial Inspection.....</b>	<b>2</b>
3.1 Ships With.....	2
<b>4. QuickStart.....</b>	<b>2</b>
4.1 Mounting Suggestions.....	2
4.2 Datalogger Programming and Wiring.....	6
<b>5. Overview.....</b>	<b>8</b>
5.1 Applications .....	8
5.2 Turbidity Units.....	9
5.3 Measurement Details.....	10
5.4 Vertical-Cavity Surface-Emitting Laser Diode.....	10
<b>6. Specifications.....</b>	<b>11</b>
<b>7. Installation.....</b>	<b>12</b>
7.1 Default Settings.....	12
7.2 Device Configuration Utility.....	13
7.3 Datalogger/RTU Connection .....	16
7.3.1 SDI-12 Wiring .....	17
7.3.2 RS-232 Wiring.....	17
7.3.3 Analog 0 to 5 Volt Wiring.....	18
7.4 Communication Modes .....	18
7.4.1 SDI-12.....	18
7.4.1.1 SDI-12 Addresses.....	20
7.4.1.2 SDI-12 Transparent Mode.....	20
7.4.2 RS-232.....	21
7.5 Calibration.....	22
7.5.1 Turbidity .....	22
7.5.2 Sediment .....	26
7.5.2.1 Dry-Sediment Calibration .....	26
7.5.2.2 Wet-Sediment Calibration .....	26
7.5.2.3 In situ Calibration.....	27
7.5.2.4 Performing a Dry-Sediment Calibration.....	27
7.6 Programming.....	28
7.6.1 SDI-12 Programming.....	29
7.6.2 RS-232 Programming .....	29
7.6.3 Analog Programming.....	29
7.7 Operation in High Sediment Loads and Sandy Sediments.....	29
7.7.1 Wiper Removal Procedure.....	30

**8. Factors that Affect Turbidity and Suspended-Sediment Measurements .....32**

8.1 Particle Size..... 32

8.2 Suspensions with Mud and Sand..... 34

8.3 Particle-Shape Effects ..... 34

8.4 High Sediment Concentrations..... 35

8.5 IR Reflectivity—Sediment Color ..... 35

8.6 Water Color ..... 36

8.7 Bubbles and Plankton..... 36

**9. Maintenance .....37**

**10. Troubleshooting.....38**

**11. References.....40**

**Appendices**

**A. Importing Short Cut Code Into CRBasic Editor ... A-1**

**B. Example Programs..... B-1**

B.1 CR1000 SDI-12 Program ..... B-1

B.2 CR1000 RS-232 Program..... B-2

B.3 CR1000 Analog Program ..... B-3

B.4 Examples for High Sediment Loads..... B-4

B.4.1 Normally Open CR1000 Example ..... B-4

B.4.2 Cycle Shutter/Wiper for Each Measurement CR1000 ProgramB-5

**C. OBS500 Copper Sleeve Kit Installation ..... C-1**

**D. SDI-12 and RS-232 Measurement Commands for OS Version 1 ..... D-1**

**Figures**

4-1. Use strain relief to keep stress off the cable and provide extra security..... 3

4-2. Apply tape to protect sensor..... 4

4-3. Secure with hose clamps. Do not overtighten. .... 4

4-4. Place and secure mounting fixture ..... 5

5-1. Drawing of the OBS500 sensor..... 10

5-2. Orientation of emitter cone (source beam) and OBS and sidescatter detector (acceptance) cones..... 11

7-1. Device Configuration Utility..... 13

7-2. Terminal Mode using 1 and H commands..... 14

7-3. Settings Editor screen ..... 15

7-4. Terminal Emulator ..... 21

7-5. Normalized response of OBS500 to AMCO Clear® turbidity. The inset shows the response function of a turbidity sensor to high-sediment concentrations. .... 23



7-6.	Position of OBS500 in clean tap water in big black tub.....	25
7-7.	OBS500 in 500-TU AMCO Clear® turbidity standard in 100-mm black polyethylene calibration cup .....	26
7-8.	Portable Sediment Suspender (left) and OBS beam orientation in suspender tub (right).....	27
7-9.	Remove the screw .....	31
7-10.	Insert screwdriver and rotate clockwise .....	31
7-11.	Shutter disassembled.....	31
7-12.	Shutter components.....	32
8-1.	Normalized sensitivity as a function of grain diameter.....	33
8-2.	The apparent change in turbidity resulting from disaggregation methods.....	33
8-3.	Relative scattering intensities of grain shapes.....	34
8-4.	Response of an OBS sensor to a wide range of SSC.....	35
8-5.	Infrared reflectivity of minerals as a function of 10-Munzell Value .....	36
9-1.	DevConfig, Send OS.....	38

## Tables

7-1.	Factory Settings .....	13
7-2.	RS-232 Terminal Commands.....	15
7-3.	OBS500 Connector Pin-Out.....	16
7-4.	SDI-12 Wiring .....	17
7-5.	RS-232 Wiring.....	17
7-6.	Analog 0-5 Volt Wiring .....	18
7-7.	SDI-12 and RS-232 Measurement Commands for OS Version 2 or Higher.....	19
7-8.	RS-232 Settings .....	22
7-9.	Calibration Materials and Volumes .....	23
7-10.	Change in TU value resulting from one hour of evaporation of SDVB standard, i.e., loss of water but not particles. ....	24
10-1.	Troubleshooting Chart. ....	39
D-1.	SDI-12 and RS-232 Measurement Commands .....	D-1

## CRBasic Examples

B-1.	CR1000 SDI-12 Program.....	B-1
B-2.	CR1000 RS-232 Program .....	B-2
B-3.	CR1000 Analog Program.....	B-3
B-4.	Normally Open CR1000 Example .....	B-4
B-5.	Cycle Shutter/Wiper for Each Measurement CR1000 Program.....	B-5



# ***OBS500 Smart Turbidity Meter with ClearSensor<sup>®</sup> Technology***

---

## **1. Introduction**

The OBS500 submersible turbidity meter is designed for general pressure measurements. The OBS500 uses ClearSensor<sup>®</sup> (U.S. Patent No. 8,429,952), an anti-fouling scheme that uses a shutter/wiper mechanism to protect and clean the optics and a refillable biocide chamber to allow biocide to leach out over the optics continually while in the closed position. It uses the SDI-12 or RS-232 communication protocol to communicate with an SDI-12 or RS-232 recorder simplifying installation and programming. It can also be used as an analog sensor with 0 to 5 V output.

---

### **NOTE**

This manual provides information only for CRBasic dataloggers. It is also compatible with most of our retired Edlog dataloggers. For Edlog datalogger support, see an older manual at [www.campbellsci.com/old-manuals](http://www.campbellsci.com/old-manuals) or contact a Campbell Scientific application engineer for assistance.

---

## **2. Precautions**

- READ AND UNDERSTAND the *Safety* section at the front of this manual.
- The OBS500 needs to be sent in after two years or 70,000 cycles for drive shaft seal replacement. (See **m8!** command in TABLE 7-7.)
- The sensor may be damaged if it is encased in ice.
- Damages caused by freezing conditions will not be covered by our warranty.
- Campbell Scientific recommends removing the sensor from the water for the time period that the water is likely to freeze.
- Sand grains between moving surfaces can jam the shutter/wiper. For high sediment load and large grain size installations, operate the OBS500 normally open to minimize the chance of sand grains jamming the shutter/wiper, and orient the sensor vertically facing downstream (see Section 7.7, *Operation in High Sediment Loads and Sandy Sediments* (p. 29)).
- Minimize temperature shock. For example, do not take sensor from sunny dashboard and immediately drop it in frigid water.
- Ensure that obstructions are not in the backscatter sensor's large field of view. See Section 4, *QuickStart* (p. 2), for more information.
- Maximum depth for the OBS500 is 100 meters.

- If possible orient the unit vertically and facing downstream.
- The probe must be calibrated with sediments from the waters to be monitored. The procedure for calibrating the probe is provided in Section 7.5, *Calibration* (p. 22).
- Sites with high sediment loads or large sand grains can be problematic for the shutter and its motor. Refer to Section 7.7, *Operation in High Sediment Loads and Sandy Sediments* (p. 29), for more information.
- The OBS500 will be damaged if it is encased in frozen liquid.
- Use electrical tape or neoprene to pad the parts of the OBS500 housing that will contact metal or other hard surfaces.
- Remember that although the OBS500 is designed to be a rugged and reliable device for field use, it is also a highly precise scientific instrument and should be handled as such.

### 3. Initial Inspection

- Upon receipt of the OBS500, inspect the packaging for any signs of shipping damage, and, if found, report the damage to the carrier in accordance with policy. The contents of the package should also be inspected and a claim filed if any shipping-related damage is discovered.
- When opening the package, care should be taken not to damage or cut the cable jacket. If there is any question about damage having been caused to the cable jacket, a thorough inspection is prudent.
- The model number is engraved on the housing. Check this information against the shipping documentation to ensure that the expected model number was received.
- Refer to the Ships With list to ensure that all parts are included (see Section 3.1, *Ships With* (p. 2)).

#### 3.1 Ships With

- (1) Calibration Certificate
- (1) 27752 OBS500 Spare Parts Kit
- (1) ResourceDVD

### 4. QuickStart

#### 4.1 Mounting Suggestions

Maximum depth for the OBS500 housing is 100 meters.

Schemes for mounting the OBS500 will vary with applications; however, the same basic precautions should be followed to ensure the unit is able to make a good measurement and that it is not lost or damaged.

- The most important general precaution is to **orient the unit so that the OBS sensor looks into clear water** without reflective surfaces. This includes any object such as a mounting structure, a streambed, or sidewalls. The backscatter sensor in the OBS500 can see to a distance of about 50 cm (20 in) in very clean water at angles ranging from 125° to 170°. The sidescatter (SS) sensor can only “see” to about 5 cm (2 in) at 90°.
- The sensor has ambient-light rejection features, but it is still best to orient it away from the influence of direct sunlight. Shading may be required in some installations to totally protect from sunlight interference.
- Nearly all exposed parts of the instrument are made of Delrin, a strong but soft plastic.

---

**CAUTION**

Always pad the parts of the OBS500 housing that will contact metal or other hard objects with electrical tape or neoprene.

---

- Mounting inside the end of a PVC pipe is a convenient way to provide structure and protection for deployments. The OBS500 will fit inside a 2-in. schedule 40 PVC pipe.

The most convenient means for mounting the unit to a frame or wire is to use large, high-strength nylon cable ties (7.6 mm (0.3 in) width) or stainless steel hose clamps. First cover the area(s) to be clamped with tape or 2 mm (1/16 in) neoprene sheet. Clamp the unit to the mounting frame or wire using the padded area. Do not tighten the hose clamps more than is necessary to produce a firm grip. Overtightening may crack the pressure housing and cause a leak. Use spacer blocks when necessary to prevent chafing the unit with the frame or wire.

**Mounting Example:**

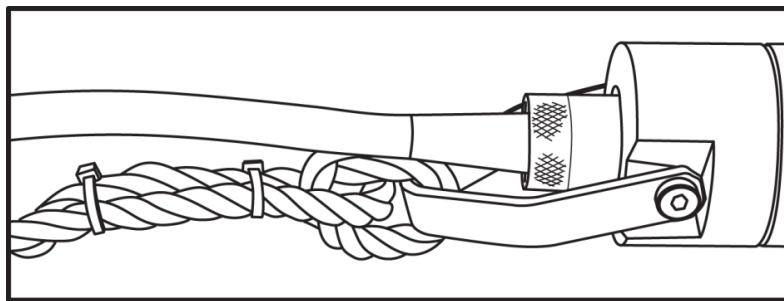

**FIGURE 4-1.** Use strain relief to keep stress off the cable and provide extra security

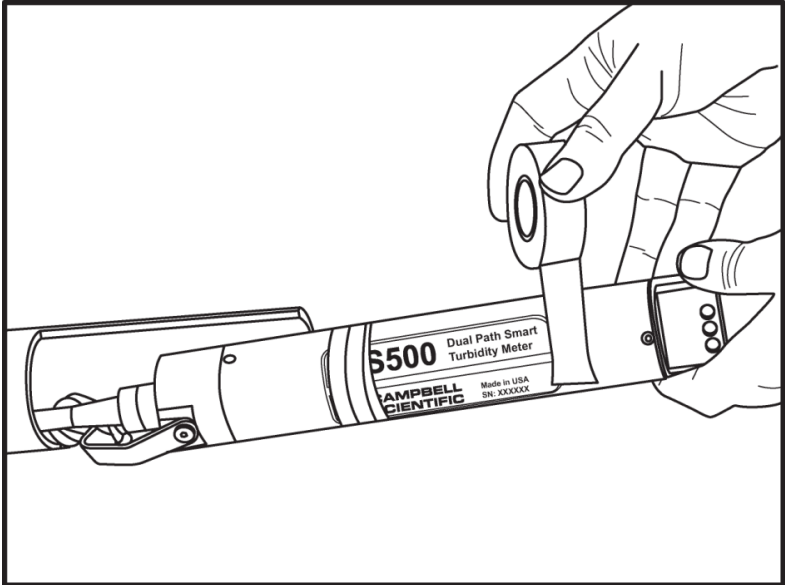

FIGURE 4-2. Apply tape to protect sensor

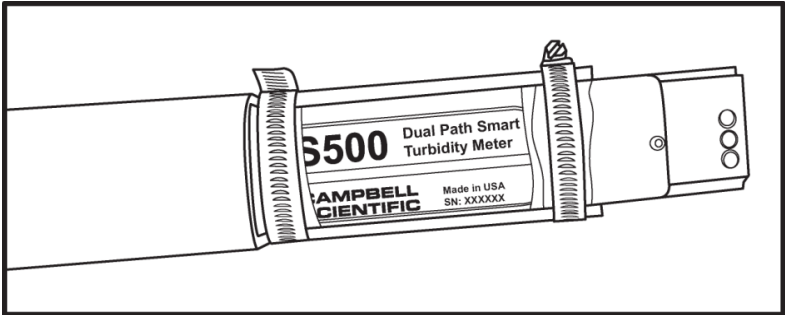

FIGURE 4-3. Secure with hose clamps. Do not overtighten.

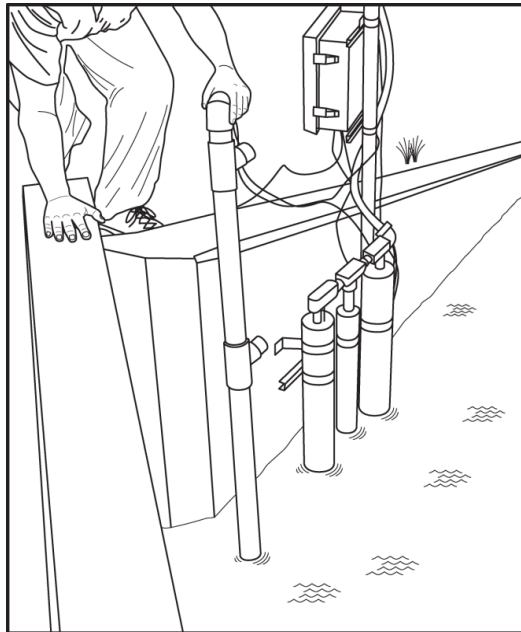
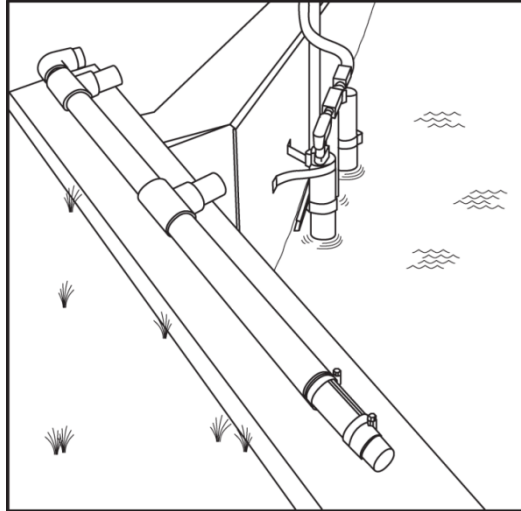

FIGURE 4-4. Place and secure mounting fixture

## 4.2 Datalogger Programming and Wiring

*Short Cut* is an easy way to program your datalogger to measure the sensor and assign datalogger wiring terminals. *Short Cut* is available as a download on [www.campbellsci.com](http://www.campbellsci.com) and the *ResourceDVD*. It is included in installations of *LoggerNet*, *PC200W*, *PC400*, or *RTDAQ*.

The following procedure shows using *Short Cut* to program the OBS500.

1. Open *Short Cut* and select **New Program**.

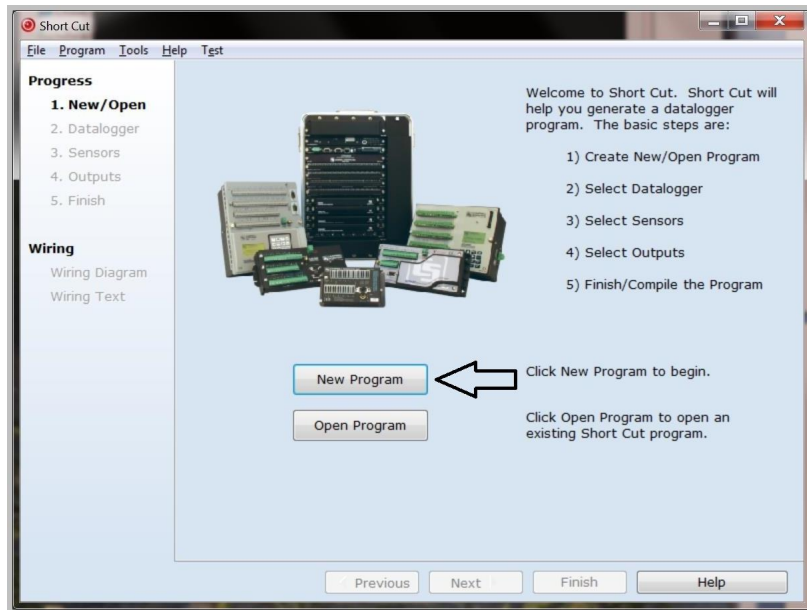

2. Select **Datalogger Model** and **Scan Interval** (default of 5 seconds is OK for most applications). Click **Next**.

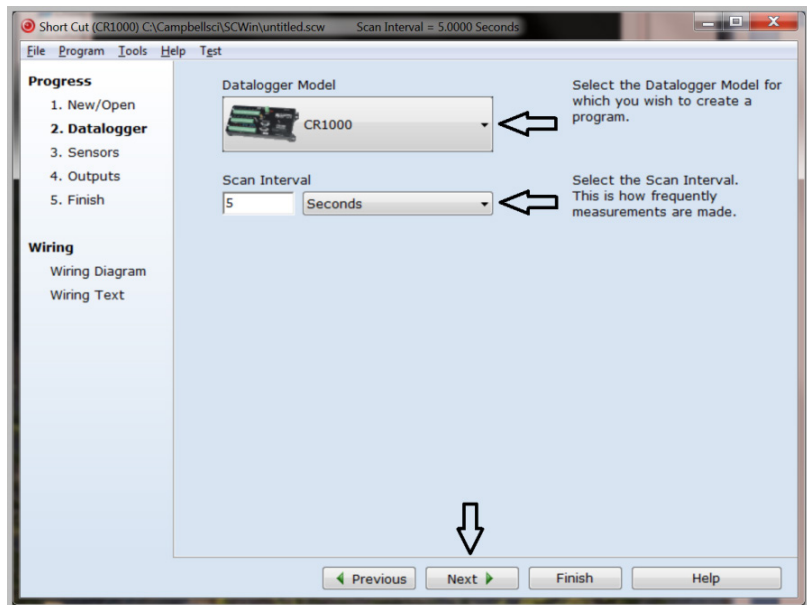



- Under the **Available Sensors and Devices** list, select the **Sensors | Water | Quality** folder. Select **OBS500 Smart Turbidity Meter**. Click  to move the selection to the **Selected** device window. Temperature defaults to degrees Celsius and the sensor is measured every scan. These can be changed by clicking the **Temperature** or **Measure Sensor** box and selecting a different option. Typically, the default SDI-12 address of 0 is used.

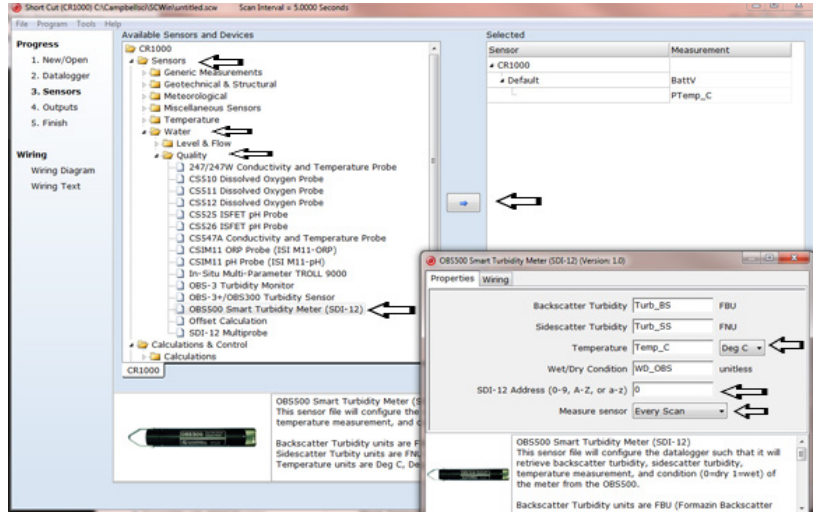

- After selecting the sensor, click **Wiring Diagram** to see how the sensor is to be wired to the datalogger. The wiring diagram can be printed now or after more sensors are added.

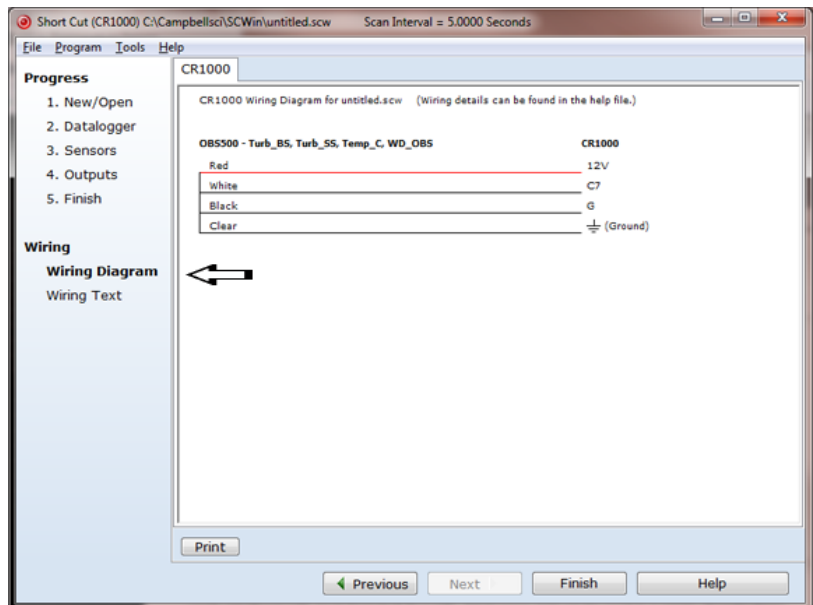

- Select any other sensors you have, then finish the remaining *Short Cut* steps to complete the program. The remaining steps are outlined in *Short Cut Help*, which is accessed by clicking on **Help | Contents | Programming Steps**.

6. If *LoggerNet*, *PC400*, or *PC200W* is running on your PC, and the PC to datalogger connection is active, you can click **Finish** in *Short Cut* and you will be prompted to send the program just created to the datalogger.
7. If the sensor is connected to the datalogger, as shown in the wiring diagram in step 4, check the output of the sensor in the datalogger support software data display to make sure it is making reasonable measurements.

## 5. Overview

The heart of the OBS500 sensor is a near-infrared (NIR) laser and two photodiodes for detecting the intensity of light scattered from suspended particles in water. One detector measures the backscatter energy, and the second is positioned at 90 degrees to the emitter to measure the sidescatter energy.

Backscatter and sidescatter sensors have unique strengths and weaknesses. Generally speaking, backscatter provides high-range (HR) measurements, and sidescatter provides low-range (LR) measurements. The OBS500 combines both in one sensor to provide unequalled performance in a field turbidity sensor. With their unique optical design (U.S. Patent No. 4,841,157), backscatter sensors perform better than most in situ turbidity monitors in the following ways:

- Measure turbidity to 4000 TU (compared to 1200 TU typically for sidescatter sensors)
- Insensitivity to bubbles and organic matter
- Ambient-light rejection
- Low temperature coefficient

Sidescatter sensors have the following advantages:

- More accurate in very clean water
- Fixed measurement volume

### 5.1 Applications

Turbidity sensors are used for a wide variety of monitoring tasks in riverine, oceanic, laboratory, and industrial settings. They can be integrated in water-quality monitoring systems, CTDs, laboratory instrumentation, and sediment-transport monitors. The electronics of the OBS500 are housed in a Delrin package, which is ideal for salt water or other harsh environments.

Applications include:

- Compliance with permits, water-quality guidelines, and regulations
- Determination of transport and fate of particles and associated contaminants in aquatic systems
- Conservation, protection, and restoration of surface waters
- Assess the effect of land-use management on water quality
- Monitor waterside construction, mining, and dredging operations
- Characterization of wastewater and energy-production effluents
- Tracking water-well completion including development and use

## 5.2 Turbidity Units

Conceptually, turbidity is a numerical expression in turbidity units (TU) of the optical properties that cause water to appear hazy or cloudy as a result of light scattering and absorption by suspended matter. Operationally, a TU value is interpolated from neighboring light-scattering measurements made on calibration standards such as Formazin, StablCal, or SDVB beads. Turbidity is caused by suspended and dissolved matter such as sediment, plankton, bacteria, viruses, and organic and inorganic dyes. In general, as the concentration of suspended matter in water increases, so will its turbidity; as the concentration of dissolved, light-absorbing matter increases, turbidity will decrease.

Descriptions of the factors that affect turbidity are given in Section 8, *Factors that Affect Turbidity and Suspended-Sediment Measurements* (p. 32). Like all other optical turbidity monitors, the response depends on the size, composition, and shape of suspended particles. For this reason, for monitoring concentrations, ***the sensor must be calibrated with suspended sediments from the waters to be monitored.*** There is no “standard” turbidimeter design or universal formula for converting TU values to physical units such as mg/l or ppm. TU values have no intrinsic physical, chemical, or biological significance. However, empirical correlations between turbidity and environmental conditions, established through field calibration, can be useful in water-quality investigations.

The USGS has an excellent chapter (6) on turbidity measurements in their “National Field Manual for the Collection of Water-Quality Data”:

[http://water.usgs.gov/owq/FieldManual/Chapter6/Section6.7\\_y2.1.pdf](http://water.usgs.gov/owq/FieldManual/Chapter6/Section6.7_y2.1.pdf)

Historically, most turbidity sensor manufacturers and sensor users labeled the units NTUs, for Nephelometric Turbidity Units. ASTM and the USGS have come up with the following unit classifications that are applicable to the OBS500:

Optical Backscatter	FBU	Formazin Backscatter Unit
Sidescatter	FNU	Formazin Nephelometric Unit
Ratio Back and Sidescatter	FNRU	Formazin Nephelometric Ratio Unit

The document “U.S. Geological Survey Implements New Turbidity Data-Reporting Procedures” details the units:

<http://water.usgs.gov/owq/turbidity/TurbidityInfoSheet.pdf>

Throughout this manual, the measurements will simply be referred to as Turbidity Units (TU).



FIGURE 5-1. Drawing of the OBS500 sensor

### 5.3 Measurement Details

The OBS500 design combines the sensor, analog measurement, and signal processing within a single housing resulting in the integration of state-of-the-art sensor and measurement technology. The 24-bit A/D has simultaneous 50/60 Hz rejection and automatic calibration for each measurement. A number of additional advanced measurement techniques are employed to harness the best possible performance available from today's state-of-the-art sensor technology. The sensor reverts to a low-power sleep state between measurements. A series of measurements is performed, yielding two turbidity and one temperature value. This measurement cycle takes about 20 seconds. The measurement cycle is activated by commands via SDI-12, RS-232 terminal commands, or a control line(s) going high (analog measurements).

The OBS500 has three communication modes: SDI-12, RS-232, or 0 to 5 V. The mode defaults to SDI-12/RS-232 but can be set in our *Device Configuration Utility (DevConfig)* to analog. As an SDI-12/RS-232 sensor, the OBS500 is shipped with an address of 0.

With SDI-12 and RS-232, the basic values output by the OBS500 are backscatter turbidity, sidescatter turbidity, and temperature. The OBS500 can also output a ratiometric measurement that combines the backscatter and sidescatter measurements. Other diagnostic information is available (see TABLE 7-7) including the raw voltage output from the backscatter and sidescatter sensors, the current to open and close the shutter, an open and close position count, total open and close cycles, and a moisture alarm. The OBS500 is shipped from the factory to output turbidity in TU and temperature in degrees Celsius. The analog output supports backscatter and/or sidescatter according to the status of a control line.

### 5.4 Vertical-Cavity Surface-Emitting Laser Diode

OBS500 sensors detect suspended matter in water and turbidity from the relative intensity of light backscattered at angles ranging from 125° to 170°,

and at 90° for the sidescatter measurement. A 3D schematic of the main components of the sensor is shown in FIGURE 5-2. The OBS500 light source is a Vertical-Cavity Surface-Emitting Laser diode (VCSEL), which converts 5 mA of electrical current to 2000  $\mu$ W of optical power. The detectors are low-drift silicon photodiodes with enhanced NIR responsivity. NIR responsivity is the ratio of electrical current produced per unit of light power in A/W. A light baffle prevents direct illumination of the detector by the light source and in-phase coupling that would otherwise produce large signal biases. A daylight-rejection filter blocks visible light in the solar spectrum and reduces ambient-light interference. In addition to the filter, a synchronous detection circuit is used to eliminate the bias caused by ambient light. The VCSEL is driven by a temperature-compensated Voltage-Controlled Current Source (VCCS).

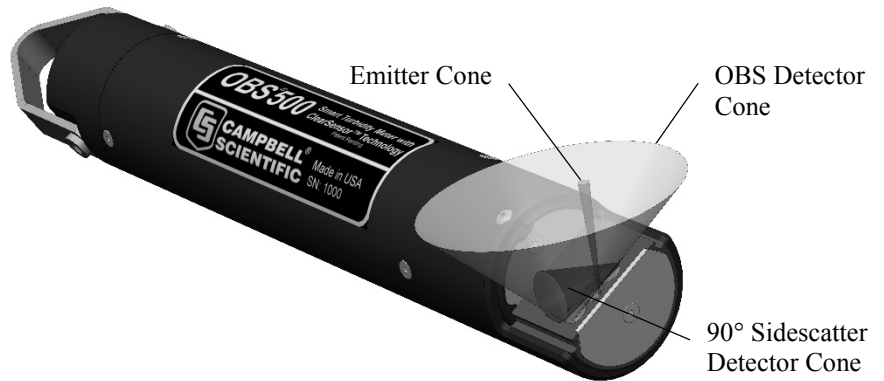

FIGURE 5-2. Orientation of emitter cone (source beam) and OBS and sidescatter detector (acceptance) cones

The beam divergence angle of the VCSEL source is 4° worst case and 2° typical (95% of the beam power is contained within a 5° cone).

## 6. Specifications

### Features:

- Dual backscatter and sidescatter sensors used to measure turbidity
- ClearSensor® antifouling method for better measurements in biologically active water
- Shutter/wiper mechanism keeps lenses clean
- Refillable biocide chamber prevents fouling
- Disposable plastic sleeve facilitates cleanup
- Optional copper sleeve for additional protection (especially for sea water) or disposable plastic sleeve facilitates easy cleanup
- Compatible with Campbell Scientific CRBasic dataloggers: CR6, CR200(X) series, CR800 series, CR1000, CR3000, and CR5000.

**Dual Probe:** Backscatter and 90-degree sidescatter

**TU Range:** 0 to 4000 TU

**Active and Passive Antifouling:** Shutter, wiper, biocide, copper, optional removable sleeve

<b>Accuracy:</b>	0.5 TU or $\pm 2\%$ of reading, whichever is greater
<b>Temperature Accuracy:</b>	$\pm 0.3$ °C, 0 to 40 °C
<b>Temperature Range:</b>	0 to 40 °C, non-freezing, ice may destroy the sensor
<b>Storage Temperature:</b>	0 to 45 °C
<b>Emitter Wavelength:</b>	850 nm
<b>Power Requirements:</b>	9.6 to 18 Vdc
<b>Power Consumption</b>	
<b>Quiescent Current:</b>	< 200 $\mu$ A
<b>Measurement/Communication Current:</b>	< 40 mA
<b>Shutter Motor Active Current:</b>	< 120 mA
<b>Maximum Peak Current:</b>	200 mA for 50 ms when shutter motor starts
<b>Cycle Time:</b>	Open, measure, close, < 25 s
<b>Measurement Time:</b>	< 2 s
<b>Outputs:</b>	SDI-12 (version 1.3) 1200 bps RS-232 9600 bps, 8 data bits, 1 stop bit, no parity, no flow control  Analog 0 to 5 Volts
<b>Submersion Depth:</b>	100 m (328 ft)
<b>Diameter:</b>	4.76 cm (1.875 in)
<b>Length:</b>	27 cm (10.625 in)
<b>Weight:</b>	0.52 kg (1.15 lb)
<b>Maximum Cable Length:</b>	460 m (1500 ft) (1 channel SDI-12 or Analog); 15 m (50 ft) (RS-232)

## 7. Installation

If you are programming your datalogger with *Short Cut*, skip Section 7.3, *Datalogger/RTU Connection* (p. 16), and Section 7.6, *Programming* (p. 28). *Short Cut* does this work for you. See Section 4, *QuickStart* (p. 2), for a *Short Cut* tutorial.

### 7.1 Default Settings

The OBS500 is configured at the factory with the default settings shown in TABLE 7-1. For most applications, the default settings are used.

SDI-12/Analog	SDI-12
SDI-12 Address	0
RS-232 Baud Rate	9600
Turbidity units	TU
Temperature units	Celsius

## 7.2 Device Configuration Utility

The *Device Configuration Utility (DevConfig)* is used to change settings, set up the analog sensor, enter RS-232 commands, and update the operating system.

Use the OBS500 test cable to connect the OBS500 to a computer running *DevConfig*. The red wire is connected to a 12 Vdc power supply and the black to ground. The datalogger power supply is a good choice to use for the power supply. *DevConfig* software is shipped on the Campbell Scientific ResourceDVD included with the OBS500.

**NOTE**

The OBS500 is supported in *DevConfig* version 1.16 or higher.

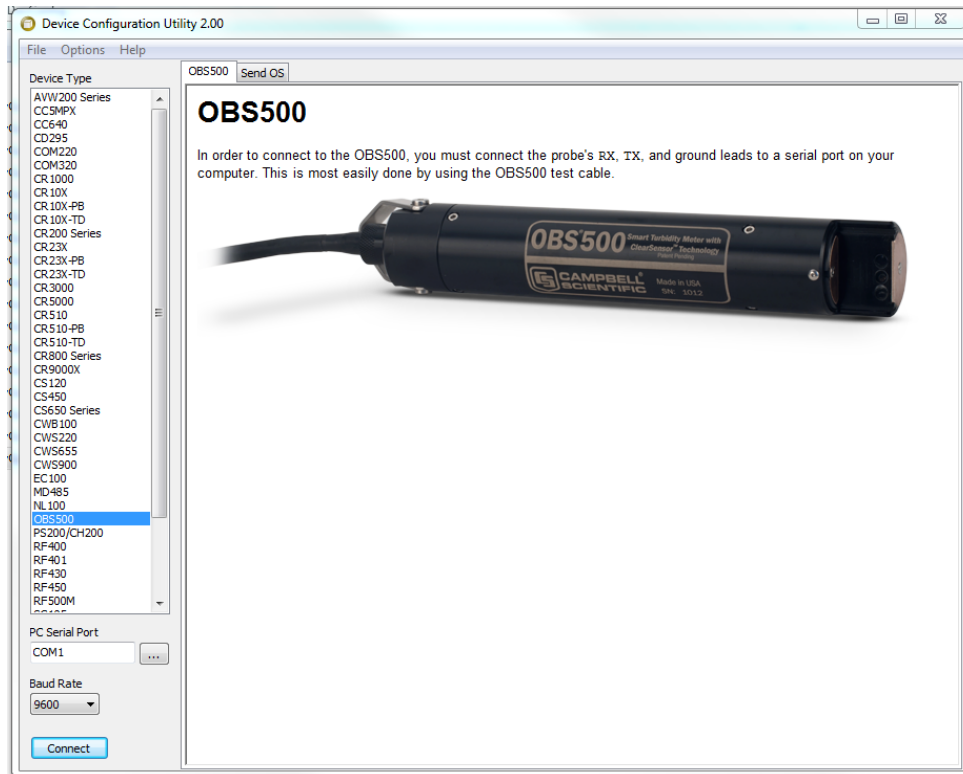

FIGURE 7-1. Device Configuration Utility

After installing *DevConfig*, select the OBS500 in the Device Type selection. Select the correct PC Serial Port and then click Connect (see FIGURE 7-1).

The Terminal tab can be used to verify the setup of the OBS500. Select the Terminal tab. Click in the Terminal window and push the Enter key several times. This will wake up the RS-232 mode of the sensor. Once successfully connected, you will see an OBS-500> prompt. FIGURE 7-2 shows *DevConfig* after pressing '1' (one) to identify the OBS500. By default, the OBS500 is in the SDI-12 mode for communication. Once in the RS-232 mode, if there is no communication for 20 seconds, the sensor will return to the SDI-12 mode.

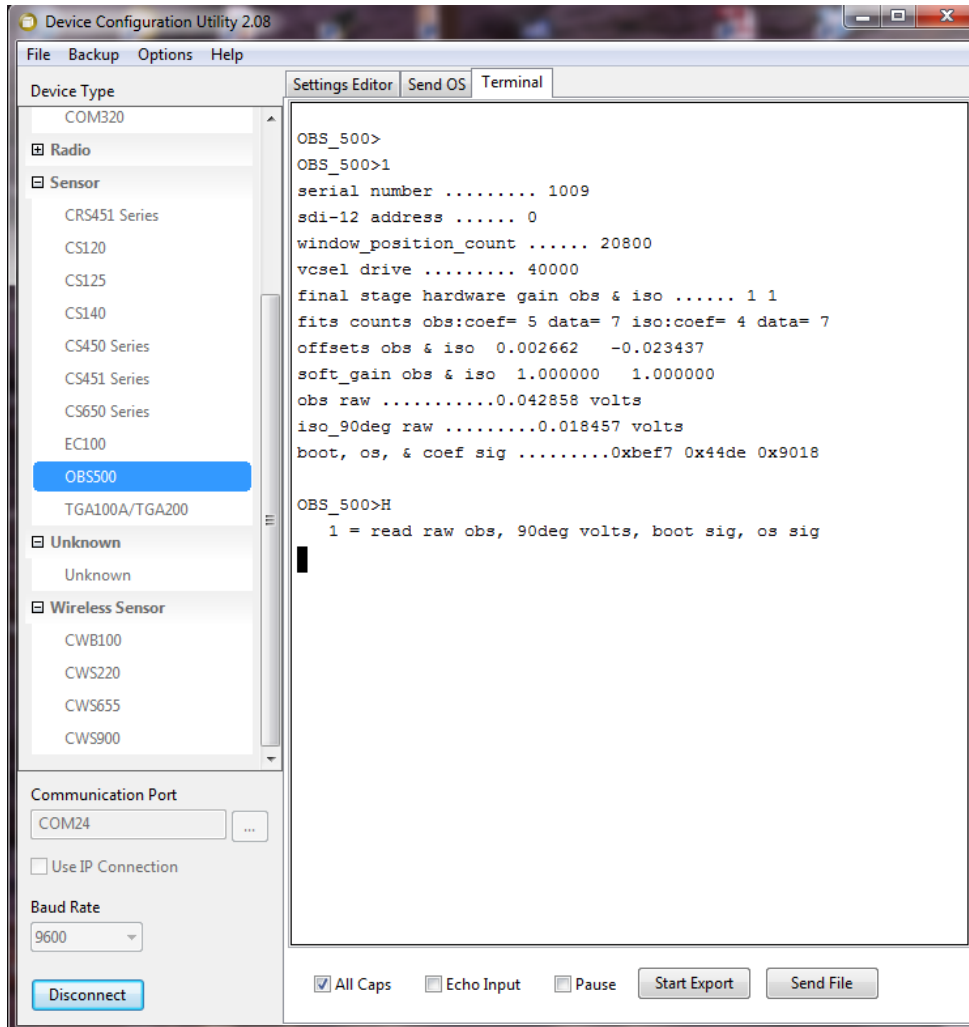

FIGURE 7-2. Terminal Mode using 1 and H commands



TABLE 7-2. RS-232 Terminal Commands	
Terminal Commands	Values Returned
1 Identify	Serial Number, SDI-12 address, etc.
2 Open Wiper	Command to open wiper started – please wait Wiper now open – average current was xxx mA
3 Close Wiper	Command to close wiper started – please wait Wiper now closed – average current was xxx mA
H or h	Help menu

DevConfig allows you to change the configuration of the OBS500.

Select the Settings Editor tab.

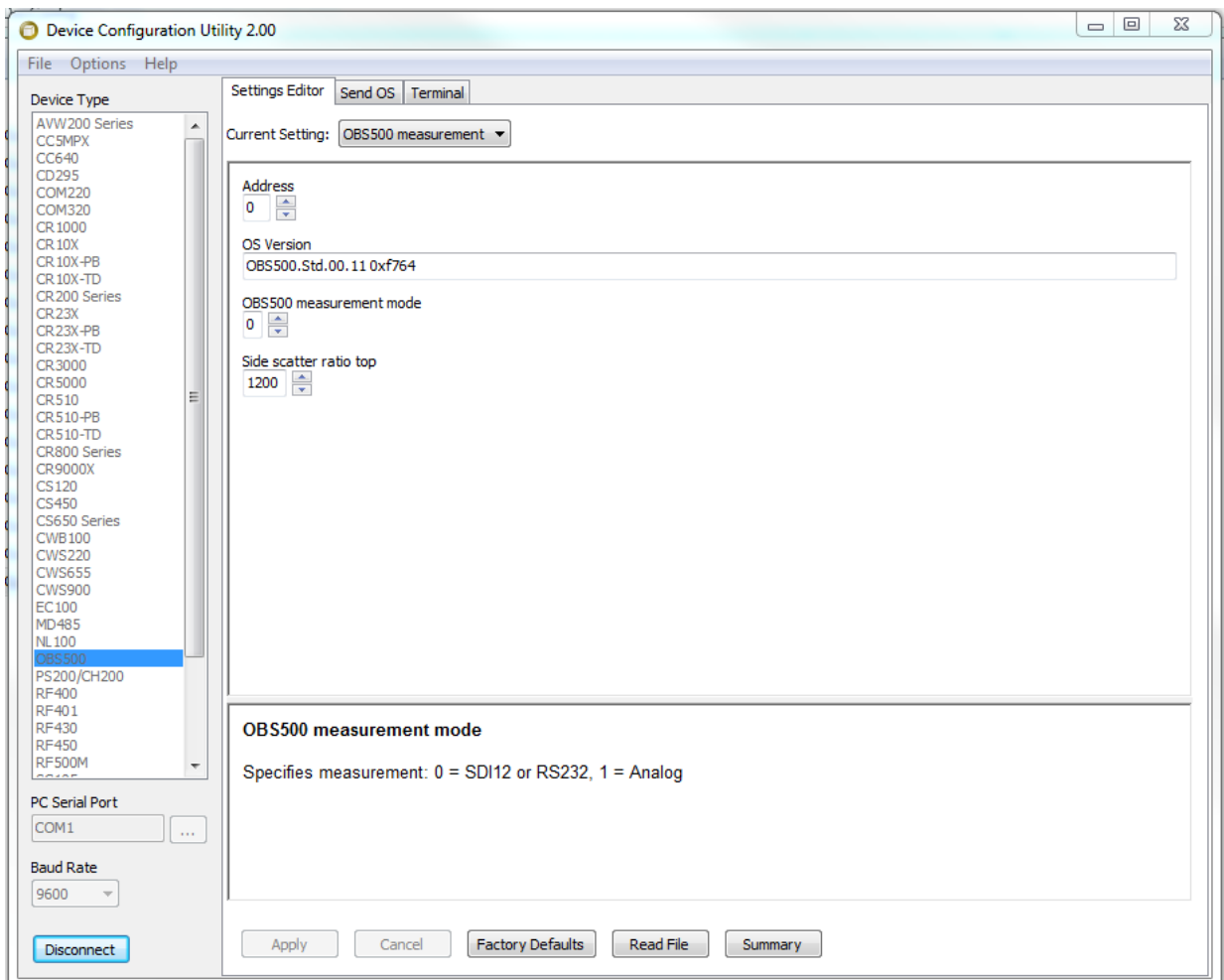

FIGURE 7-3. Settings Editor screen

There are three settings that can be changed: SDI-12 address, measurement mode, and sidescatter ratio top. Select the desired values and press the Apply button.

---

**NOTE** The SDI-12 address is not used while in analog mode.

---

### 7.3 Datalogger/RTU Connection

The OBS500 field cable is typically used to connect to a datalogger or RTU. The field cable is a molded-cable assembly that terminates with an MCIL wet pluggable underwater terminator. TABLE 7-3 shows the contact numbers for the MCIL/MCBH-8 connectors and the electrical functions and wire colors.

TABLE 7-3. OBS500 Connector Pin-Out		
MCIL-8-MP/MCBH-8-FS Contact Number	Electrical Function	Wire Color
1	Power Ground	Black
2	SDI-12/RS232 TX/Analog SS-BS Control	White
3	Power (9.6 to 15 V)	Red
4	Analog Signal	Green
5	RS-232 RX/Shutter Open	Blue
6	NC	
7	Analog Ground	Brown
8	NC	
No Connection		Clear/Braid

This document provides the recommended wiring configuration for connecting the OBS500 field cable to a Campbell Scientific datalogger. Wiring to dataloggers or RTUs manufactured by other companies is similar.

---

**NOTE** Campbell Scientific recommends powering down the system before wiring the OBS500. The shield wire plays an important role in noise emissions and susceptibility as well as transient protection.

---

### 7.3.1 SDI-12 Wiring

TABLE 7-4. SDI-12 Wiring				
Color	Description	CR800 CR5000 CR3000 CR1000	CR200X Series	CR6
Red	Power	12V	Battery+	12V
Black	Power Ground	G	G	G
White	SDI-12 Signal	Control Port <sup>1</sup>	C1/ SDI-12	Control Port <sup>1</sup> or Universal Channel <sup>1</sup>
Brown	not used	not used	not used	not used
Blue	not used	not used	not used	not used
Green	not used	not used	not used	not used
Clear	Shield	G	G	G
<sup>1</sup> Only odd control ports or universal channels can be used for SDI-12 (for example, C1, C3...)				

### 7.3.2 RS-232 Wiring

Our CR800, CR850, CR1000, and CR3000 dataloggers have COM ports (control port Tx/Rx pairs) that can be used to measure RS-232 sensors. Both the C and U terminals can be configured as Tx/Rx pairs for measuring RS-232 sensors.

TABLE 7-5. RS-232 Wiring			
Color	OBS500 Function	Connection	RS-232 9-pin / Datalogger Control Port
Red	+12VDC	Power Source	
Black	Power Ground	Power Ground	
White	RS-232 Tx (Output)	Transmit	Pin 2 Rx (Input)/ Control Port Rx
Blue	RS-232 Rx (Input)	Receive	Pin 3 Tx (Output)/ Control Port Tx
Brown			
Green			
Clear	Shield GND	Ground	

### 7.3.3 Analog 0 to 5 Volt Wiring

Color	Description	CR6, CR800, CR850, CR1000, CR3000, CR5000
Blue	Shutter Open - Control High	Control Port
White	Backscatter (Low) or Sidescatter (High) Control	Control Port
Green	Signal	Differential High or Single-Ended Input
Brown	Analog Ground	Differential Low or Analog Ground
Black	Power Ground	G
Red	Power	SW12V
Clear	Shield	G

The measurement sequence is to raise the blue wire from ground to 5 volts to open the shutter, delay 6 seconds, and then measure the backscatter analog output on the green wire. If sidescatter is desired, then raise the white wire from ground to 5 volts, delay 3 seconds, and then measure the sidescatter analog output on the green wire. In either case, lower the blue wire to ground to close the shutter. Note that measurements can be differential or single-ended. Differential measurements are recommended.

The output is scaled as 1 mV per TU. For example, 100 mV = 100 TU, 4000 mV = 4000 TU.

## 7.4 Communication Modes

### 7.4.1 SDI-12

The OBS500 uses an SDI-12-compatible hardware interface and supports a subset of the SDI-12 commands. The most commonly used command is the **aM!** command, issued by the datalogger. Here, *a* represents the sensor address (0 to 9). The communication sequence begins with the datalogger waking the sensor and issuing the **aM!** command. The sensor responds to the datalogger indicating that two measurements will be ready within two (2) seconds. Subsequent communications handle data reporting from the sensor to the datalogger.

The SDI-12 protocol has the ability to support various measurement commands. TABLE 7-7 provides the commands available for the OBS500 operating system (OS) version 2 or higher.

#### NOTE

If you have OS version 1, see Appendix D, *SDI-12 and RS-232 Measurement Commands for OS Version 1 (p. D-1)*. Use the **aI!** SDI-12 command or use *DevConfig* to see the OS version downloaded to your OBS500. The OS version can be updated by using *DevConfig*.

<b>TABLE 7-7. SDI-12 and RS-232 Measurement Commands for OS Version 2 or Higher</b>		
<b>Commands</b>	<b>Process</b>	<b>Values Returned</b>
<b>aM!</b> <b>aC!</b> a = address	Open Wiper Measure Close Send Data	obs (tu) ss (tu) temperature (°C) wet dry (0=dry 1=wet)
<b>aC1!</b>	Burst Data Open Wiper Measure 100 Times Close Send Data	bs median bs mean bs standard deviation bs minimum bs maximum ss median ss mean ss standard deviation ss minimum ss maximum.
<b>aM2!</b> <b>aC2!</b>	Open Wiper Measure Close Send Data	obs (tu) ss (tu ) ratio (tu) temperature (°C) raw obs (V) raw ss (V) open current (mA) close current (mA) wet dry (0=dry 1=wet)
<b>aM3!</b> <b>aC3!</b>	Open Wiper Send Data	open wiper position count open max current count open timeout count open current (mA) total open/close count
<b>aM4!</b> <b>aC4!</b>	Measure Send Data	obs (tu) ss (tu) temperature (°C) wet dry (0=dry 1=wet)
<b>aC5!</b>	Burst Data Measure 100 Times Send Data	bs median bs mean bs standard deviation bs minimum bs maximum ss median ss mean ss standard deviation ss minimum ss maximum.
<b>aM6!</b> <b>aC6!</b>	Measure Send Data	obs (tu) ss (tu ) ratio (tu) temperature (°C) raw obs (V) raw ss (V) open current (mA) close current (mA) wet dry (0=dry 1=wet)

TABLE 7-7. SDI-12 and RS-232 Measurement Commands for OS Version 2 or Higher		
Commands	Process	Values Returned
<b>aM7!</b> <b>aC7!</b>	Close Wiper Send Data	close wiper position count close max current count close timeout count close current (mA) total open/close count
<b>aC8!</b>	Raw Burst Data in Volts Open Measure 100 Times Close Send Data	bs median bs mean bs Standard deviation bs minimum bs maximum ss median ss mean ss standard deviation ss minimum ss maximum.
<b>aM9!</b>	Wiper Leave Open	total open/close count open wiper position count open max current count open timeout count close wiper position count close max current count close timeout count

**7.4.1.1 SDI-12 Addresses**

The OBS500 SDI-12 address can be set to 0 to 9, A to Z, or a to z which allows multiple sensors to be connected to a single digital I/O channel (control port) of an SDI-12 datalogger. (Most Campbell Scientific dataloggers support SDI-12.)

The OBS500 is shipped from the factory with the address set to 0. When it is necessary to measure more than one OBS500, it is easiest to use a different control port for each OBS500 instead of changing the address. If additional control ports are not available, the address will need to be changed.

The address on the OBS500 can be changed by sending the SDI-12 change address command **aAb!**. The change address command can be issued from most SDI-12 recorders. For example, to change the address of a sensor that has a default address of 0 to the address of 1 the following command can be sent:

**0A1!**

The address may also be changed by connecting to the probe in *DevConfig*. Once connected, in the Settings Editor tab click in the address box and enter the new address. Press Apply to save the changes.

**7.4.1.2 SDI-12 Transparent Mode**

The transparent mode allows direct communication with the OBS500. This may require waiting for programmed datalogger commands to finish before sending responses. While in the transparent mode, datalogger programs may not execute. Datalogger security may need to be unlocked before the transparent mode can be activated.

The transparent mode is entered while the PC is in telecommunications with the datalogger through a terminal emulator program. It is most easily accessed through Campbell Scientific datalogger support software, but it is also accessible with terminal emulator programs such as Windows Hyperterminal.

To enter the SDI-12 transparent mode, enter the terminal emulator from *LoggerNet*, *PC400*, or *PC200W* datalogger support software. A terminal emulator screen is displayed. Click the **Open Terminal** button.

For CR800 series, CR1000, and CR3000 dataloggers, press <Enter> until the datalogger responds with the prompt (e.g., “CR1000>” for the CR1000). Type *SDI12* at the prompt and press <Enter>. In response, the query *Enter Cx Port 1,3,5 or 7* will appear. Enter an integer value indicating the control port to which the OBS500 is connected. A response of *Entering SDI12 Terminal* indicates that SDI-12 Transparent Mode is active. Any of the SDI-12 commands may be entered (e.g., **aM1!** where *a* refers to the address). After entering a command, the results may be viewed by entering **ad!**.

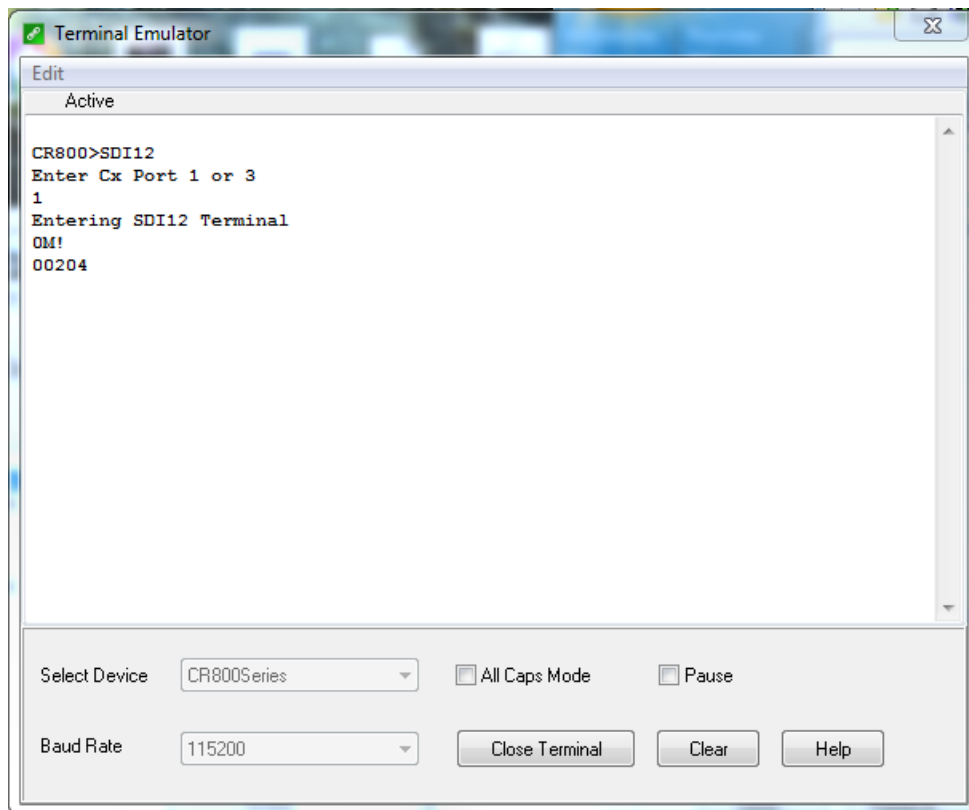

FIGURE 7-4. Terminal Emulator

Only one sensor of the same address can be connected when using the change address command.

## 7.4.2 RS-232

RS-232 measurements of the OBS500 are typically made by a CR800, CR850, CR1000, or CR3000 datalogger or an RTU device. The OBS500 field cable is

used and wired appropriately for the measurement device. See TABLE 7-8 for settings.

<b>TABLE 7-8. RS-232 Settings</b>	
Bits per second	9600
Data bits	8
Parity	None
Stop bits	1
Flow control	None

Measurement commands are the same for RS-232 and SDI-12 as shown in TABLE 7-7.

## 7.5 Calibration

### 7.5.1 Turbidity

Field recalibration is not recommended and usually not needed until the OBS500 is sent back to Campbell Scientific for the two year service. We recommend checking the calibration in the field as described below. If a 9-point calibration is needed, the OBS500 should be sent to Campbell Scientific to perform the calibration.

The normalized response of an OBS500 sensor to SDVB turbidity over the range from 0 to 4,000 TU is shown in FIGURE 7-5. As shown on the inset, the response function is contained within region A, the linear region, of the universal response curve. However, there is residual nonlinearity that is removed by calibration and by computation of a TU value with a 2nd-order polynomial. This section explains how to do a turbidity calibration.



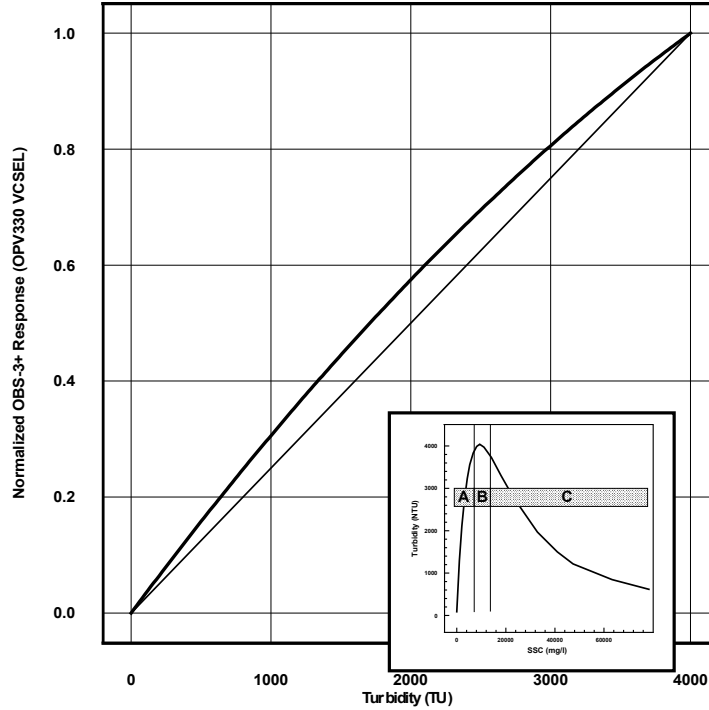

FIGURE 7-5. Normalized response of OBS500 to AMCO Clear® turbidity. The inset shows the response function of a turbidity sensor to high-sediment concentrations.

AMCO Clear® SDVB turbidity standards are used to calibrate an OBS500 sensor. SDVB standards are made for individual instruments. Standards made for one model of turbidity meter cannot be used to calibrate a different model.

TABLE 7-9. Calibration Materials and Volumes	
Sidescatter 90-Degree Materials	Calibration Cup Diameter (mm/inches)
8594 - 20TU	100 (~4)
8595 - 40TU	100 (~4)
8596 - 125TU	100 (~4)
8597 - 250TU	100 (~4)
8598 - 500TU	100 (~4)
8599 - 1000TU	100 (~4)
OBS Sensor Material	
8600 - 125TU	200 (~7.9)
8601 - 250TU	200 (~7.9)
8602 - 500TU	200 (~7.9)
8603 - 1000TU	100 (~4)
8604 - 2000TU	100 (~4)
8605 - 4000TU	100 (~4)

The GFS item numbers, standard values, and volumes required for the standard low ranges are given in TABLE 7-9. SDVB standards have a shelf life of two years provided that they are stored in tightly sealed containers and evaporation is minimized.

The TU values of the standards will remain the same as long as the ratio of particle mass (number of particles) to water mass (volume) does not change. Evaporation causes this ratio to increase, and dust, bacteria growth, and dirty glassware can also cause it to increase. Therefore, take the following precautions. 1) Always use clean glassware and calibration containers. 2) Don't leave standards on the bench in open containers or leave the standard bottles uncapped. Perform the calibration as quickly as possible and return the AMCO solutions to their bottles. 3) Clean dirty sensors with a clean, alcohol-soaked cloth to sterilize them before dipping them into the standards. 4) Transfer entire bottles between containers. To avoid aeration, do not shake excess fluid off the glassware.

Because of the intrinsic errors in the TU value of formazin used by the SDVB manufacturer (GFS Chemicals) and the dilution procedures, the uncertainty in the TU value of an SDVB standard is  $\pm 1\%$  of the value indicated on the standard bottle. Consequently, the TU value of one liter of standard in an uncovered 100-mm calibration cup will increase  $\sim 1\%$  in 10 hours on a typical summer day (R.H. = 90% and air temp. = 18 °C). For example, the TU value of a 2000-TU standard in a 100-mm cup will increase by about 2 TU (0.1%) per hour. TABLE 7-10 gives the increases for some other commonly used standards.

<b>TABLE 7-10. Change in TU value resulting from one hour of evaporation of SDVB standard, i.e., loss of water but not particles.</b>				
Calibration-cup Size $\phi$ mm ( $\phi$ in)	250 TU	500 TU	2000 TU	4000 TU
100 (4)	+0.26	+0.52	+2.10	+4.20
150 (6)	+0.60	+1.20	+4.80	+9.70

**Materials and equipment:** OBS500 with cable, datalogger, large black polyethylene plastic tub (0.5 M I.D. X 0.25 M deep) for measuring the clear-water points, and 100-mm and 200-mm black PE (polyethylene) calibration cups.

**Procedure**

1. Swab sensor with an alcohol-soaked towel to sterilize it. Position the OBS sensor in a large, black tub of fresh tap water as shown in FIGURE 7-6 and record a 10-second average of the low-range output. Record the average output on the calibration log sheet.

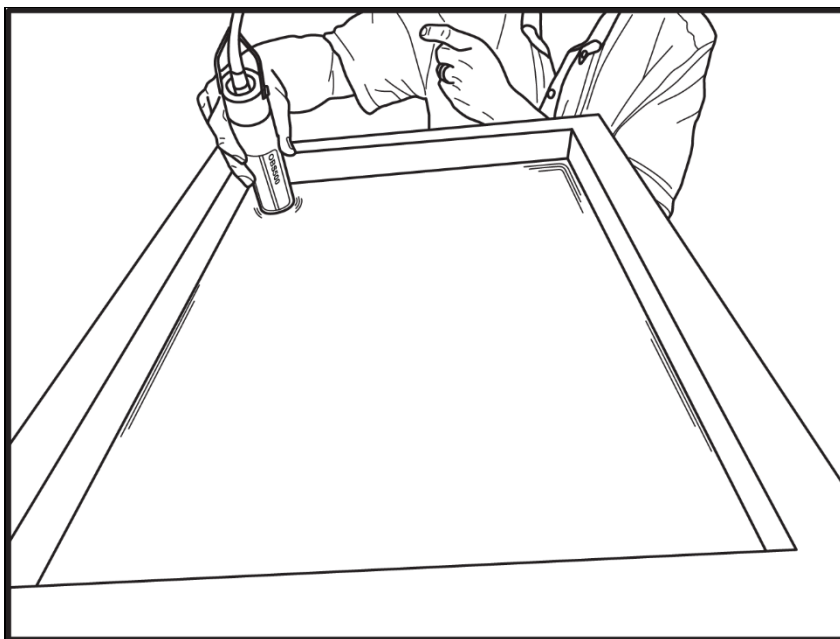
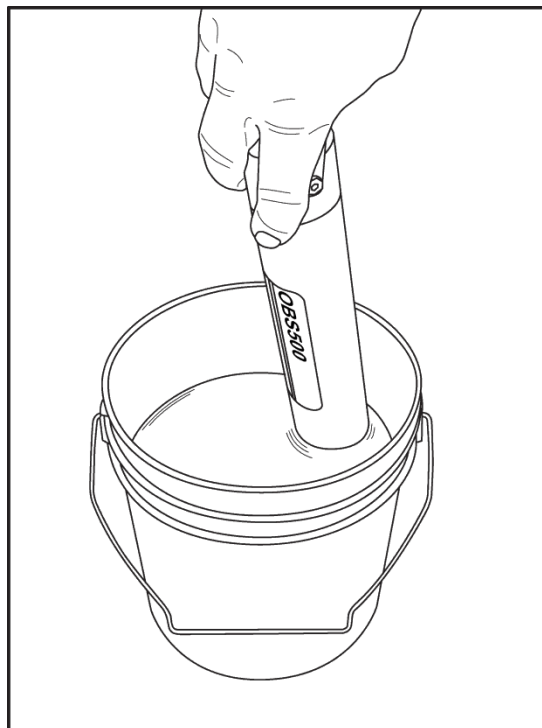

FIGURE 7-6. Position of OBS500 in clean tap water in big black tub

2. Pour the first SDVB standard into the appropriately sized cup (see TABLE 7-9).
3. Position the OBS sensor in the cup as shown in FIGURE 7-7 and record 10-second averages of the low- and high-range outputs. Record the average outputs on the calibration log sheet.
4. Pour the standard back into its container.
5. Wipe sensor with a clean, dry towel to remove residual standard.
6. Repeat steps 2, 3, 4, and 5 for the other standards.
7. Perform 2<sup>nd</sup>-order polynomial regressions on the calibration data to get the coefficients for converting OBS signals to TU values.



*FIGURE 7-7. OBS500 in 500-TU AMCO Clear® turbidity standard in 100-mm black polyethylene calibration cup*

## **7.5.2 Sediment**

There are three basic ways to calibrate an OBS sensor with sediment. These are described in the following sections. However, only the procedures for dry-sediment are explained in this manual. Typically, the sensor will record in turbidity units and the relationship to suspended sediment is calculated in a spread sheet or database after the data is retrieved to a computer.

### **7.5.2.1 Dry-Sediment Calibration**

Dry-sediment calibration is a calibration performed with sediment that has been dried, crushed, and turned to powder. This is the easiest calibration to do because the amount of sediment can be determined accurately with an electronic balance and the volume of water in which it is suspended can be accurately measured with volumetric glassware. Of the three methods, dry-sediment calibration causes the greatest physical and chemical alteration of the sediment. Alteration of the sediment size as a result of processing can significantly affect the calibration slope. FIGURE 7-5 shows, for example, that reducing the grain size by a factor of two during grinding can increase OBS sensitivity by a factor of two.

### **7.5.2.2 Wet-Sediment Calibration**

Wet-sediment calibration is performed with sediment obtained from water samples or from the bed of a river that has not been dried and pulverized. Consolidation and biochemical changes during storage and processing cause some alteration of wet sediment, and for this reason, sediment and water samples should be stored at about 4 °C prior to use. The wet sediment is introduced into the sediment suspender as it comes from the field. This kind of

calibration requires that water samples be withdrawn from the suspender after each addition of sediment for the determination of SSC (suspended sediment concentration) by filtration and gravimetric analysis.

### 7.5.2.3 In situ Calibration

In situ calibration is performed with water samples taken from the immediate vicinity of an OBS sensor in the field over sufficient time to sample the full range of SSC values to which a sensor will be exposed. SSC values obtained for these samples with concurrent recorded OBS500 signals and regression analysis establishes the mathematical relation for future SSC conversions by an instrument. This is the best sediment-calibration method because the particles are not altered from their natural form in the river (see Lewis, 1996). It is also the most tedious, expensive, and time-consuming method. It can take several years of water sampling with concurrent OBS measurements to record the full range of SSC values on a large river.

### 7.5.2.4 Performing a Dry-Sediment Calibration

**Materials and equipment:** OBS500 with test cable; dry, disaggregated sediment from the location where the OBS500 will be used (sediment should be in a state where grinding, sieving, or pulverization does not change its particle-size distribution); datalogger with 12 V power supply; sediment suspender (if a suspender is not available, use a 200 mm I.D. dark plastic container and a drill motor with paint-mixing propeller); electronic balance calibrated with 10 mg accuracy; 20 ml weigh boats; large, black polyethylene plastic tub for measuring the clear-water points; 1 liter, class A, volumetric flask; tea cup with round bottom; and teaspoon.

1. Check the balance with calibration weights; recalibrate if necessary.
2. Connect the OBS500 to a computer or datalogger so that the measured values can be observed.
3. Add three liters of tap water to the suspender tub with the volumetric flash.
4. After measuring the clear-water signal (Step 1, Section 7.5.1, *Turbidity* (p. 22)), mount the OBS500 so that the sensor end is 50 mm above the bottom of the suspender tub and secure it in the position that minimizes reflections from the wall; see FIGURE 7-8.



FIGURE 7-8. Portable Sediment Suspender (left) and OBS beam orientation in suspender tub (right)

$SSC = W_{ts} [V_w + W_{ts}/\rho_s]^{-1}$ , where  $W_{ts}$  = total sediment weight in tub in mg,  $V_w$  = volume of water in liters,  $\rho$  = density of water ( $\rho = 1.0 \text{ kg L}^{-1}$  at  $10^\circ \text{C}$ ), and  $\rho_s$  = sediment density (assume  $2.65 \cdot 10^3 \text{ mg L}^{-1}$ )

### Procedure

1. Record and log the clean-water signal as in Step 1, Section 7.5.1, *Turbidity* (p. 22); see FIGURE 7-6. Use the same value, such as, sidescatter, backscatter, or ratio throughout the calibration.
2. Move the OBS500 to the suspender as described in setup.
3. Weigh  $500 \pm 10$  mg of sediment in a weigh boat and transfer it to the teacup. Record the weight on the calibration log sheet and add about 10 cc of water from the suspender tub to the teacup and mix the water and sediment into a smooth slurry with the teaspoon.
4. Add the sediment slurry to the tub and rinse the teacup and spoon with tub water to get all the material into the suspender.
5. Turn the suspender on and let it run for 10 minutes or until the OBS signal stabilizes.
6. Take averages of signals with the computer or datalogger and enter them on the calibration log sheet.
7. Calculate the sediment-weight increment as follows:  $W_i = 2500 \text{ mg}$  ( $4000/V_x$ ), where  $W_i$  = the incremental weigh of sediment and  $V_x$  = the average output signal from step 6. The resulting weight gives the amount of sediment to add in order to have evenly spaced calibration points.
8. Add enough additional sediment to get one full increment of sediment,  $W_i \pm 5\%$ . Repeat steps 4, 5, and 6.
9. Repeat step 8 until five full increments of sediment have been added or until the OBS signals exceed the output range.
10. Perform 3<sup>rd</sup> order polynomial regressions on the data to get the coefficients for converting OBS output to SSC.

## 7.6 Programming

*Short Cut* is the best source for up-to-date datalogger programming code. Programming code is needed when:

- Creating a program for a new datalogger installation
- Adding sensors to an existing datalogger program

If your data acquisition requirements are simple, you can probably create and maintain a datalogger program exclusively with *Short Cut*. If your data acquisition needs are more complex, the files that *Short Cut* creates are a great source for programming code to start a new program or add to an existing custom program.

---

**NOTE** *Short Cut* cannot edit programs after they are imported and edited in *CRBasic Editor*.

---

A *Short Cut* tutorial is available in Section 4, *QuickStart* (p. 2). If you wish to import *Short Cut* code into *CRBasic Editor* to create or add to a customized program, follow the procedure in Appendix A, *Importing Short Cut Code Into CRBasic Editor* (p. A-1).

Programming basics for CRBasic dataloggers are provided in the following sections. Complete program examples for select CRBasic dataloggers can be found in Appendix B, *Example Programs* (p. B-1). Programming basics and programming examples for Edlog dataloggers are provided at [www.campbellsci.com/old-manuals](http://www.campbellsci.com/old-manuals).

### 7.6.1 SDI-12 Programming

The **SDI12Recorder** instruction is used to read the OBS500 in SDI-12 mode. A multiplier of 1.0 and an offset of 0.0 yield water level in psig and temperature in degrees C.

The **SDI12Recorder** instruction has the following form:

**SDI12Recorder**(Destination, Output String, Multiplier, Offset)

Refer to Appendix B.1, *CR1000 SDI-12 Program* (p. B-1), for an example of using this CRBasic instruction.

### 7.6.2 RS-232 Programming

The **SerialOut()** instruction sends strings over the Tx COM port and the **SerialIn()** instruction receives strings from the Rx COM port.

Refer to Appendix B.2, *CR1000 RS-232 Program* (p. B-2), for an example of using these CRBasic instructions.

### 7.6.3 Analog Programming

The **PortSet** instruction is used to open the shutter. Either the **VoltDiff** (recommended) or **VoltSe** instruction is used to measure the analog voltage output.

Refer to Appendix B.2, *CR1000 RS-232 Program* (p. B-2), for an example of using these CRBasic instructions.

## 7.7 Operation in High Sediment Loads and Sandy Sediments

Sites with high sediment loads and large sand grains can be problematic for the shutter and its motor. The recommendations provided in this section should help reduce these problems.

---

**NOTE** Typically sites with high biological growth have relatively low sediment loads.

---

1. Run the OBS500 in a normally open mode. For example, close then open the wiper once every four hours. This reduces the wear on the motor significantly, and save power. The interval can be adjusted over time. Increase the interval if experiencing fouling. If the windows are staying clean, slow it down even more. Example CRBasic programs are provided at Appendix B.4, *Examples for High Sediment Loads* (p. B-4).
  - a. **M3!** opens the wiper
  - b. **M4!**, **M5!**, or **M6!** perform measurements when the wiper is open
  - c. **M7!** closes the wiper
2. Clean the shutter assembly. The frequency that the shutter should be cleaned depends on the sediment load and can vary from weeks to months (step 3 can help you determine the required frequency for cleaning). Two levels of cleaning should be done;
  - a. flush the wiper as it opens and closes with a stream of clean water, or
  - b. remove the wiper from the OBS500 by removing one screw and follow the directions provided in Section 7.7.1, *Wiper Removal Procedure* (p. 30). Flush and clean.
3. Store the current used to open and close the slider. The open and close SDI-12 instructions (M3! and M7!) output the current. Normally the current is around 100 mA. As sand grits lodge in the grooves, the resistance to movement increases and the motor has to work harder. This increases the current usage. Therefore, increased current usage indicates that the wiper needs to be cleaned (see step 2).
4. Mount the sensor between 45 degrees pointing down to vertical hanging down.

### 7.7.1 Wiper Removal Procedure

1. Remove the stop screw in the OBS500 housing at the end of the shutter/wiper slot.
2. Remove the 4-40 flat head screw and copper plate to expose the drive shaft access port (FIGURE 7-9).
3. Insert a slot screw driver (2.5 mm (0.1 in.) wide blade) into the access port (FIGURE 7-10).
4. Engage the end of the drive shaft and then rotate clockwise until the shutter is free (FIGURE 7-10 and FIGURE 7-11).

---

**CAUTION**

Keep track of all of the components (FIGURE 7-12).

---

5. Reassemble by reversing the steps.



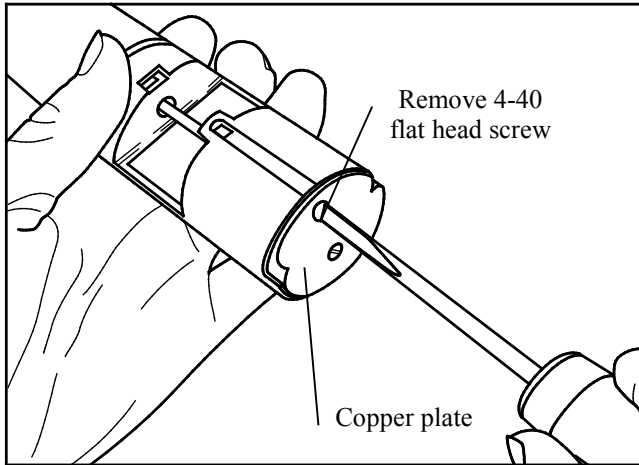

FIGURE 7-9. Remove the screw

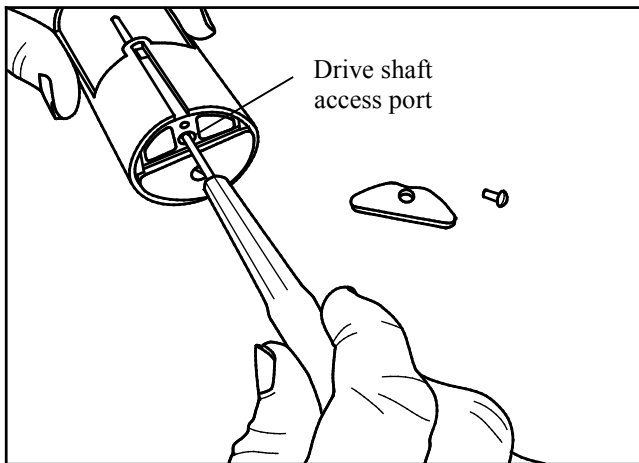

FIGURE 7-10. Insert screwdriver and rotate clockwise

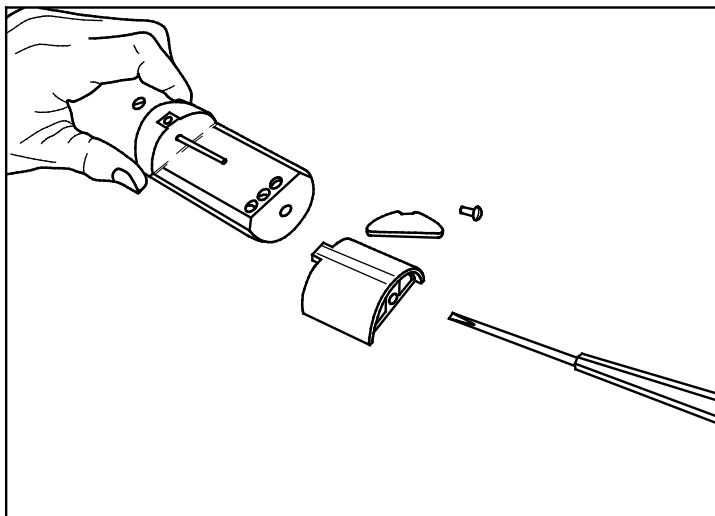

FIGURE 7-11. Shutter disassembled

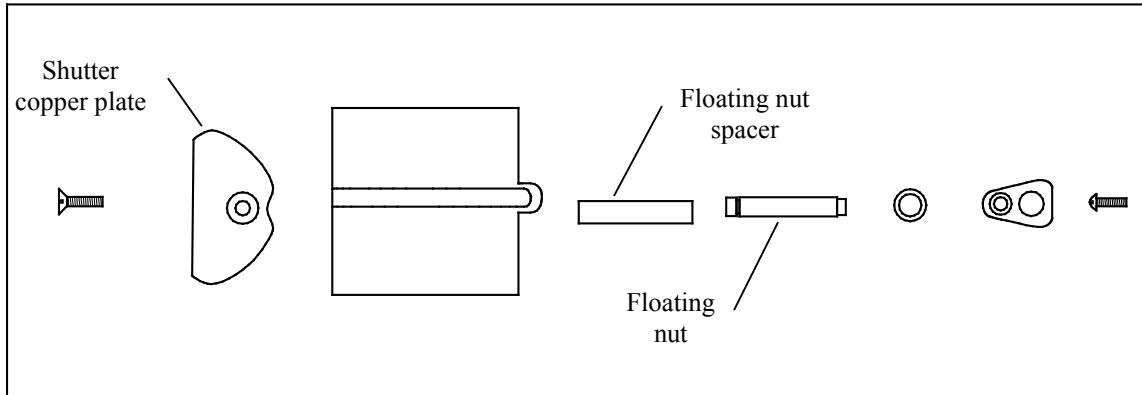

FIGURE 7-12. Shutter components

## 8. Factors that Affect Turbidity and Suspended-Sediment Measurements

This section summarizes some of the factors that affect OBS measurements and shows how ignoring them can lead to erroneous data. If you are certain that the characteristics of suspended matter will not change during your survey and that your OBS was factory-calibrated with sediment from your survey site, you only need to skim this section to confirm that no problems have been overlooked.

### 8.1 Particle Size

The size of suspended sediment particles typically ranges from about 0.2 to 500  $\mu\text{m}$  in surface water (streams, estuaries, and the ocean). With size, shape, and color remaining constant, particle area normal to a light beam will determine the intensity of light scattered by a volume of suspended matter. Results of tests with sediment shown in FIGURE 8-1 indicate a wide range of sensitivity is associated with fine mud and coarse sand (about two orders of magnitude). The significance of these results is that size variations between the field and laboratory and within a survey area during monitoring will produce shifts in apparent TU and SSC values that are unrelated to real changes in sediment concentration. FIGURE 8-2 shows the difference in apparent turbidity that can result from different ways of disaggregating sediment.

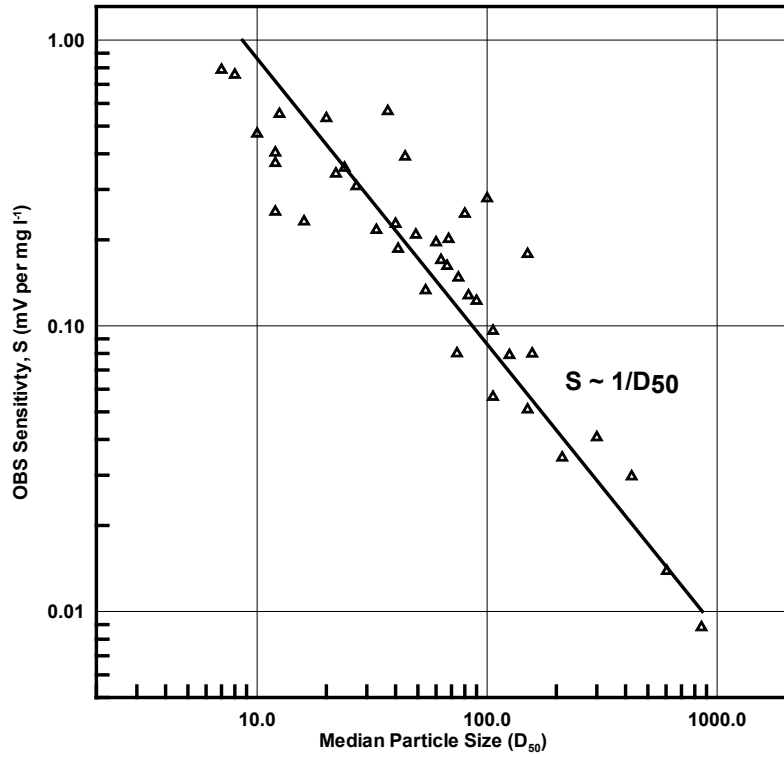

FIGURE 8-1. Normalized sensitivity as a function of grain diameter

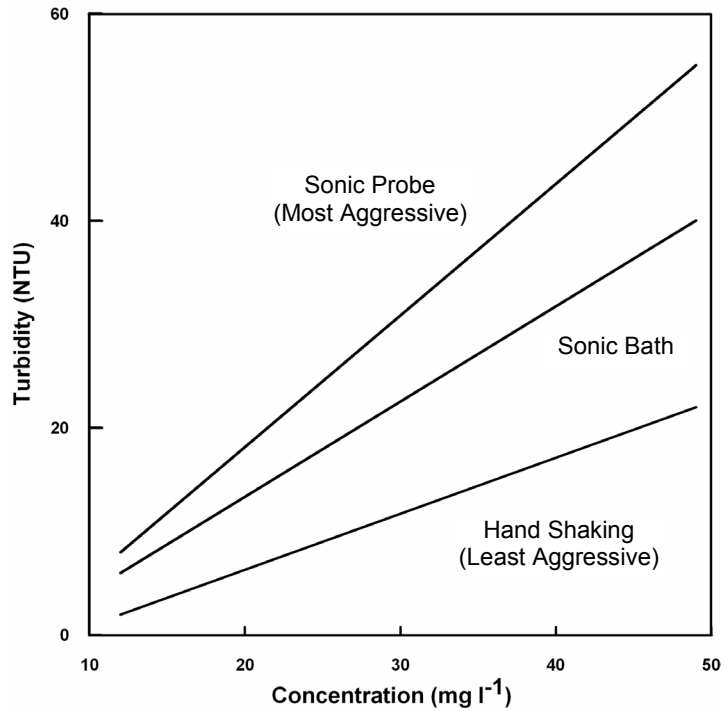

FIGURE 8-2. The apparent change in turbidity resulting from disaggregation methods

## 8.2 Suspensions with Mud and Sand

As mentioned in Section 8.1, *Particle Size* (p. 32), light scattering from particles is inversely related to particle size on a mass concentration basis. This can lead to serious difficulties in flow regimes where particle size varies with time. For example, when sandy mud goes through a cycle of suspension and deposition during a storm, the ratio of sand to mud in suspension will change. A turbidity sensor calibrated for a fixed ratio of sand to mud will, therefore, indicate the correct concentration only part of the time. There are no simple remedies for this problem. One solution is to take a lot of water samples and analyze them in the laboratory. This is not always practical during storms when the errors are likely to be largest. Do not rely solely on turbidity sensors to monitor suspended sediments when particle size or composition is expected to change with time at a monitoring site.

## 8.3 Particle-Shape Effects

In addition to size and flocculation/aggregation, particle shape has a significant effect on the scattering intensity from a sample and calibration slope of a turbidity sensor. As the graph in FIGURE 8-3 shows, plate-shaped particle (clay-mineral particles, for example) backscatter light about ten times more efficiently than spherical particles, and angular shapes have intermediate scattering efficiency. Turbidity sensors are very sensitive to shape effects and this makes it very important to calibrate with material from the monitoring site. It is also essential that particle shape remains constant during the monitoring period.

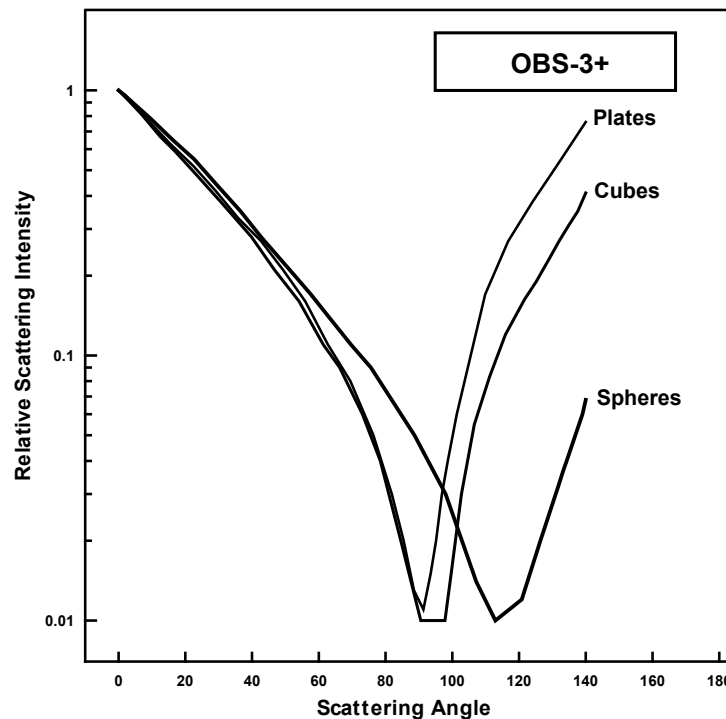

FIGURE 8-3. Relative scattering intensities of grain shapes

## 8.4 High Sediment Concentrations

At high sediment concentrations, particularly in suspensions of clay and silt, the infrared radiation from the emitter can be so strongly attenuated along the path connecting the emitter, the particle, and the detector, that backscatter decreases exponentially with increasing sediment concentration. For mud, this occurs at concentrations greater than about 5,000 mg/l. FIGURE 8-4 shows a calibration in which sediment concentrations exceeding 6,000 mg/l cause the output signal to decrease. It is recommended not to exceed the specified turbidity or suspended sediment ranges, otherwise the interpretation of the signal can be ambiguous. For example, a signal level of 2,000 mV (FIGURE 8-4) could be interpreted to indicate SSC values of either 3,000 or 33,000 mg/l. Factory calibrations are performed in the linear region designated 'A' on the graph.

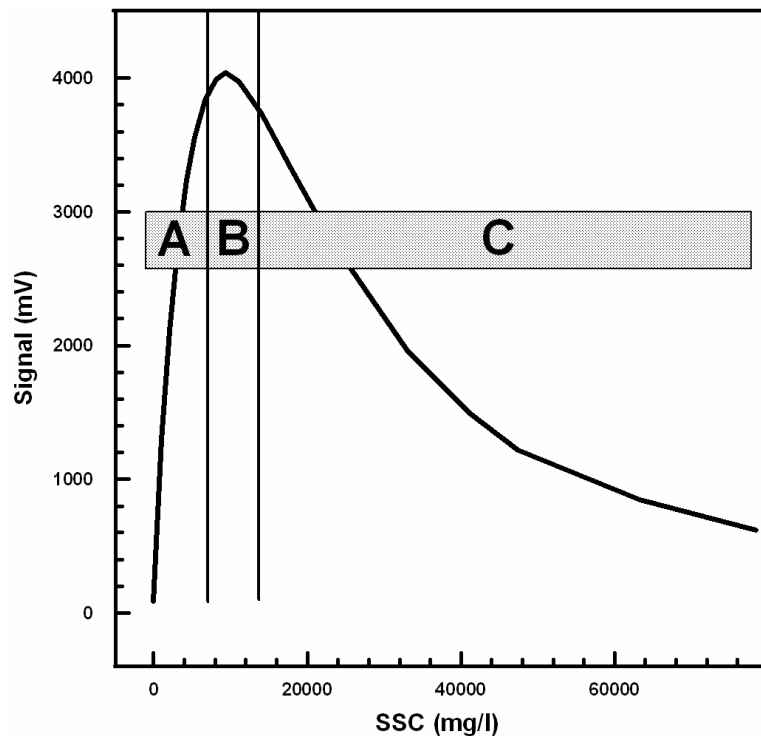

FIGURE 8-4. Response of an OBS sensor to a wide range of SSC

## 8.5 IR Reflectivity—Sediment Color

Infrared reflectivity, indicated by sediment color, has a major effect on sensitivity because with other factors remaining constant, it changes the intensity of light scattering. Although turbidity sensors are color blind, tests have shown that “whiteness”, color, and IR reflectivity are correlated. Calcite, which is highly reflective and white in color, will produce a much stronger turbidity signal on a mass-concentration basis than magnetite, which is black and IR-absorbing. Sensitivity to colored silt particles varies from a low of about one for dark sediment to a high of about ten for light gray sediment; see FIGURE 8-5. In areas where sediment color is changing with time, a single calibration curve may not work. Resulting errors will depend on the relative concentrations of colored sediments.

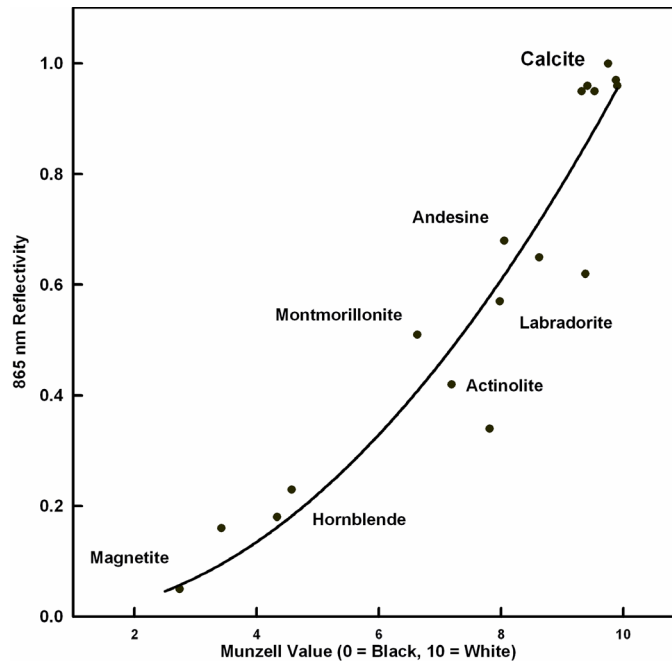

FIGURE 8-5. Infrared reflectivity of minerals as a function of 10-Munzell Value

## 8.6 Water Color

Some OBS users have been concerned that color from dissolved substances in water samples, not colored particles as discussed in Section 8.5, *IR Reflectivity—Sediment Color* (p. 35), produces erroneously low turbidity measurements. Although organic and inorganic IR-absorbing, dissolved matter has visible color, its effect on turbidity measurements is small unless the colored compounds are strongly absorbing at the sensor wavelength (850 nm) and are present in high concentrations. Only effluents from mine-tailings produce enough color to absorb measurable IR. In river, estuary, and ocean environments, concentrations of colored materials are too low by at least a factor of ten to produce significant errors.

## 8.7 Bubbles and Plankton

Although bubbles efficiently scatter light, monitoring in most natural environments shows that OBS signals are not strongly affected by bubbles. The sidescatter measurement may be more affected. Bubbles and quartz particles backscatter nearly the same amount of light to within a factor of approximately four, but most of the time bubble concentrations are at least two orders of magnitude less than sand concentrations. This means that sand will produce much more backscatter than bubbles in most situations, and bubble interference will not be significant. Prop wash from ships and small, clear, mountain streams where aeration produces high bubble concentrations are exceptions to this generality and can produce erroneous turbidity values resulting from bubbles.

OBS sensors detect IR backscattered between 90° and 165° where the scattering intensities are nearly constant with the scattering angle. Particle concentration has the most significant effect in this region. OBS sensors are

more sensitive, by factors of four to six, to mineral particles than particulate organic matter, and interference from these materials can, therefore, be ignored most of the time. One notable exception is where biological productivity is high and sediment production from rivers and re-suspension is low. In such an environment, OBS signals can come predominately from plankton.

## 9. Maintenance

There is a biocide chamber in the slider that is refillable. The default biocide from the factory is copper braid. The braid will last for many years, but it can be replaced as desired. Other solid biocides can be placed in the chamber. To be effective over time, the biocide should be slow to dissolve.

The OBS500 should be sent in for service (seal, shaft, and nut replacement) after 2 years or 70,000 cycles of the shutter, whichever occurs first. The sensor has a cycle count and a moisture alarm in the data string (SDI-12 and RS-232 only). If the seals are not replaced, the sensor will eventually leak and potentially be destroyed. It is recommended that the cycles and moisture alarm be recorded regularly. If a moisture alarm is recorded, the sensor shutter should be parked and the sensor taken out of the water and returned for repair as soon as possible.

---

**WARNING**

**Other than the sleeve and the biocide chamber on the sensor tip, there are no user-serviceable parts inside the sensor housing. Do not remove the sensor or connector from the pressure housing. This will void the warranty and could cause a leak.**

---

Plastic (pn 27473) and copper (pn 27803) sleeves are available for the OBS500 to reduce required cleaning. The plastic sleeve is intended to be disposable. The copper sleeve should slow fouling growth, but it may need to be cleaned. If the sleeve becomes encrusted with organisms, such as barnacles or tube worms, remove the sleeve. The sleeve can be soaked in weak acids or other cleaning products that are compatible with copper. The sleeve may have to be gently scraped with a flexible knife blade followed by a ScotchBrite scouring pad.

---

**WARNING**

**Do not use solvents such as MEK, Toluene, Acetone, or trichloroethylene on OBS sensors.**

---

### Downloading a New Operating System

*DevConfig* is used to download a new operating system to the OBS500. Select the Send OS tab and follow the directions on the screen.

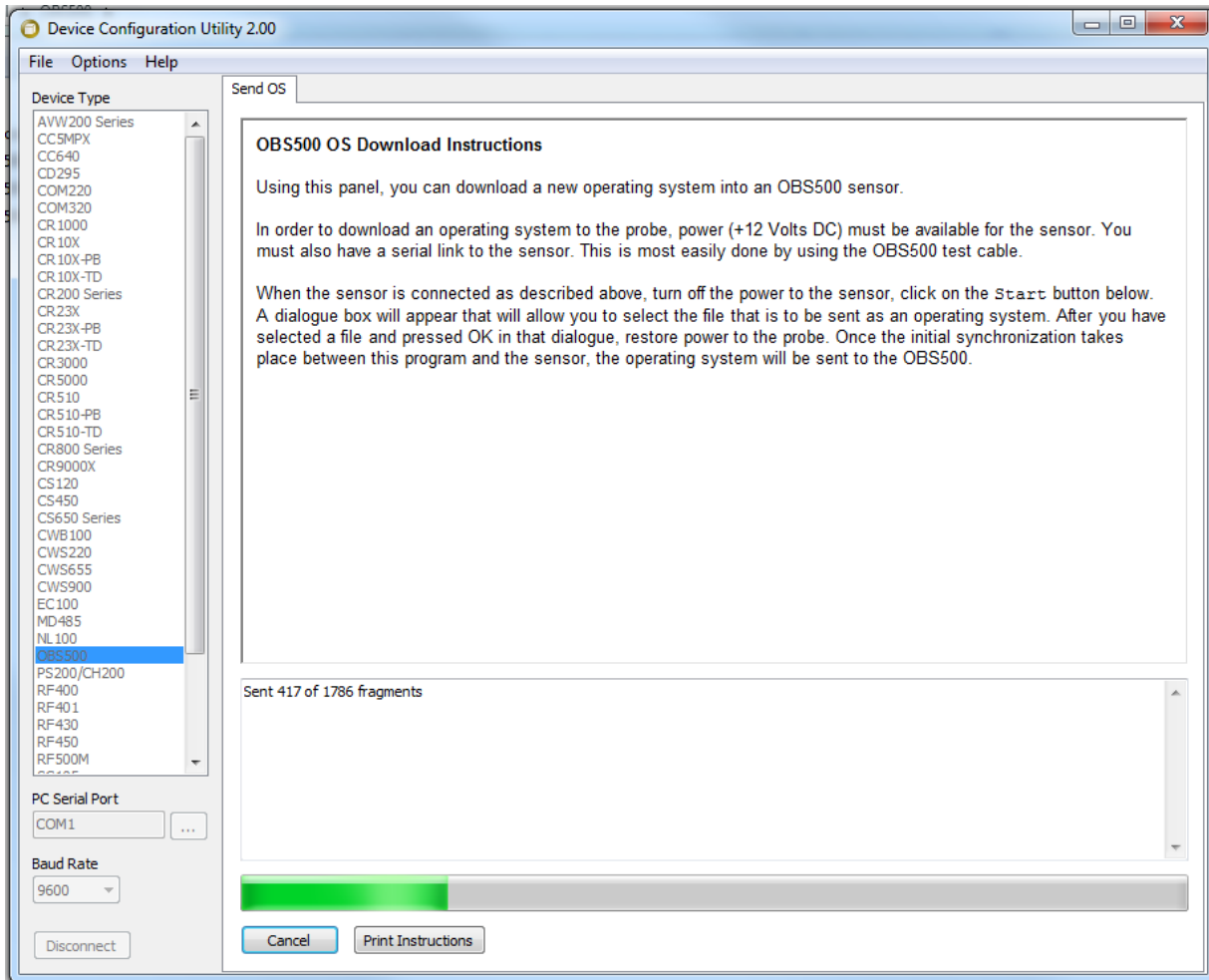

FIGURE 9-1. DevConfig, Send OS

## 10. Troubleshooting

A common cause for erroneous, turbidity-sensor data is poor sensor connections to the datalogger.

*Problem:*

Unit will not respond when attempting serial communications.

*Suggestion:*

Check the power (Red is +V and Black is Ground) and signal (White is SDI-12 Data) lines to ensure proper connection to the datalogger. Check the datalogger program to ensure that the same port the SDI-12 data line is connected to is specified in the measurement instruction.



The following three tests are used to diagnose malfunctions of an OBS500.

1. The **Finger-Wave Test** is used to determine if an OBS sensor is ‘alive’. Power the OBS sensor and connect datalogger (see Section 7.2, *Device Configuration Utility (p. 13)*). Wave your finger across the sensor window about 20 mm away from it. The datalogger should show the output fluctuating from a few TU to the full-scale signal. If there are no signal fluctuations of this order, there is a problem that requires attention.
2. The **Shake Test** is done to determine if water has leaked inside the pressure housing. Unplug the cable and gently shake the sensor next to your ear and listen for sloshing water. This test gives a false negative result when the amount of water in the housing is large enough to destroy the circuit but too small to be audible.
3. A **Calibration Check** is done to verify if a working OBS sensor needs to be recalibrated. In order to be meaningful, the user must have a criterion for this test. For example, this criterion might be 5%. The sensor is placed in calibration standards with the 1<sup>st</sup> and 2<sup>nd</sup> TU values listed in FIGURE 7-5 and the datalogger readings are logged. If either reading differs by more than 5% from ones reported on the factory calibration certificate, or the user’s own calibration data, the sensor should be recalibrated. If the first two calibration points fall within the acceptance criterion, then the third value can be tested. The recommended frequency for calibration checks is quarterly when an OBS sensor is in regular use. Otherwise it should be performed prior to use. Calibration checks can be done in the field.

**TABLE 10-1. Troubleshooting Chart.**

<b>Fault</b>	<b>Cause of Fault</b>	<b>Remedy</b>
Fails finger-wave test	No power, dead battery	Replace battery and reconnect wires.
	Plug not fully seated	Disconnect and reinsert plug.
	Sensor broken	Visually inspect for cracks. Return OBS500 to manufacturer if cracks are found.
	Electronic failure. Unit draws less than 11 mA or more than 40 mA.	Return OBS500 to manufacturer.
Fails shake test	Sensor leaked	Return OBS500 to manufacturer.
Fails calibration check	Aging of light source causes it to become dimmer with time	Recalibrate (see Section 7.5, <i>Calibration (p. 22)</i> ).

## 11. References

Anderson, C.W., 2005, Turbidity (ver. 2.1): U.S. Geological Survey Techniques of Water-Resources Investigations, book 9, chap. A6., sec. 6.7, Sept 2005, accessed December 8, 2011, from <http://pubs.water.usgs.gov/twri9A6/>.

Boyd Bringhurst and Jeff Adams. “Innovative Sensor Design for Prevention of Bio-fouling.” Oceans 2011, September 2011.

Lewis, Jack. 1996. Turbidity-controlled Suspended Sediment Sampling for Runoff-event Load Estimation. Water Resources Research, 32(7), pp. 2299-2310.

“U.S. Geological Survey Implements New Turbidity Data-Reporting Procedures.” U.S. Geological Survey. <http://water.usgs.gov/owq/turbidity/TurbidityInfoSheet.pdf>.

# Appendix A. Importing Short Cut Code Into CRBasic Editor

---

This tutorial shows:

- How to import a *Short Cut* program into a program editor for additional refinement
- How to import a wiring diagram from *Short Cut* into the comments of a custom program

*Short Cut* creates files, which can be imported into *CRBasic Editor*. Assuming defaults were used when *Short Cut* was installed, these files reside in the C:\campbellsci\SCWin folder:

- .DEF (wiring and memory usage information)
- .CR6 (CR6 datalogger code)
- .CR2 (CR200(X) datalogger code)
- .CR1 (CR1000 datalogger code)
- .CR8 (CR800 datalogger code)
- .CR3 (CR3000 datalogger code)
- .CR5 (CR5000 datalogger code)

Use the following procedure to import *Short Cut* code and wiring diagram into *CRBasic Editor*.

1. Create the *Short Cut* program following the procedure in Section 4, *QuickStart* (p. 2). Finish the program and exit *Short Cut*. Make note of the file name used when saving the *Short Cut* program.
2. Open *CRBasic Editor*.
3. Click **File | Open**. Assuming the default paths were used when *Short Cut* was installed, navigate to C:\CampbellSci\SCWin folder. The file of interest has the .CR6, .CR2, .CR1, .CR8, .CR3, or .CR5 extension. Select the file and click **Open**.
4. Immediately save the file in a folder different from C:\Campbellsci\SCWin, or save the file with a different file name.

---

## NOTE

Once the file is edited with *CRBasic Editor*, *Short Cut* can no longer be used to edit the datalogger program. Change the name of the program file or move it, or *Short Cut* may overwrite it next time it is used.

---

5. The program can now be edited, saved, and sent to the datalogger.
6. Import wiring information to the program by opening the associated .DEF file. Copy and paste the section beginning with heading “-Wiring for CRXXX-” into the CRBasic program, usually at the head of the file. After pasting, edit the information such that an apostrophe (') begins each line.

This character instructs the datalogger compiler to ignore the line when compiling.

# Appendix B. Example Programs

---

## B.1 CR1000 SDI-12 Program

Although this is a CR1000 program, other CRBasic dataloggers are programmed similarly.

### CRBasic Example B-1. CR1000 SDI-12 Program

```
'CR1000 Series Datalogger
'Declare Public Variables

Public SDI (4)

'Declare Other Variables

Alias SDI(1) = OBS
Alias SDI(2) = SS
Alias SDI(3) = Temp
Alias SDI(4) = WetDry

'Define Data Tables
DataTable (Test,1,1000)
  DataInterval (0,15,Min,10)
  Sample (1,OBS,FP2)
  Sample (1,SS,FP2)
  Sample (1,Temp,FP2)
  Sample (1,WetDry,FP2)
EndTable

'Main Program
BeginProg
  Scan (30,Sec,0,0)

  SDI12Recorder (SDI(),1,0,"M!",1.0,0)

'Call Output Tables
  CallTable Test
  NextScan
EndProg
```

## B.2 CR1000 RS-232 Program

Although this is a CR1000 program, other CRBasic dataloggers are programmed similarly.

### CRBasic Example B-2. CR1000 RS-232 Program

```
'CR1000 Series Datalogger

'Declare Public Variables

Public RS232 (5)
Public Counter
Public OutString As String * 20
Public OutString2 As String * 10
Public InString As String * 100

'Declare Other Variables
'RS232(1) is the address
Alias RS232(2) = OBS
Alias RS232(3) = SS
Alias RS232(4) = Temp
Alias RS232(5) = WetDry

'Define Data Tables
DataTable (Test,1,1000)
DataInterval (0,60,Min,10)
Sample (1,OBS,FP2)
Sample (1,SS,FP2)
Sample (1,Temp,FP2)
Sample (1,WetDry,FP2)
EndTable

'Main Program
BeginProg

  SerialOpen (Com1,9600,0,0,150)

  Scan (30,Sec,0,0)

  OutString2 = CHR (13)           'a series of carriage returns will put OBS500 into RS-232 mode

  OutString = "0M!" + CHR (13)   'address and then use commands M to M8

  'Send String over communication port C1 (COM1 TX).
  SerialOut (Com1,OutString2,"OBS_500",15,100) 'put OBS500 into RS232 mode
  delay (1,1,Sec)
  SerialOut (Com1,OutString,"",0,1000) 'send command,

  'Receive String over communication port C1 (COM1 RX).

  SerialIn (InString,Com1,5,33,150) 'The sensor echoes back the command ending with an "!" (CHR 33)
  SerialIn (InString,Com1,2500,62,150) 'The sensor will open, close and after about 20 seconds
  'send "OBS_500>" and then the data. CHR 62 is ">"
  SerialIn (InString,Com1,100,13,200) 'Now the data comes ending with a carriage return, CHR 13
  SplitStr (RS232(C),InString,"",5,0) 'Split the ASCII string into numeric variables

  'Call Output Tables
  'Example:
  CallTable Test
NextScan
EndProg
```

## B.3 CR1000 Analog Program

Although this is a CR1000 program, other CRBasic dataloggers are programmed similarly.

### CRBasic Example B-3. CR1000 Analog Program

```
'CR1000 Series Datalogger
'OBS500_analog_O&M.CRI for the CR1000
'wiring: Green to 1H; Brown to 1L; Red to SW12; Black to Grnd; Blue to C1; and White to C2

'Declare Public Variables
Public PTemp, batt_volt
Public Results (2)
Alias Results(1)=obs
Alias Results(2)=ss

Units obs=NTU
Units ss=NTU

DataTable (OBS500_analog,1,-1)
  DataInterval (0,3,min,10)
  Minimum (1,batt_volt,FP2,0,False)
  Sample (1,PTemp,FP2)
  Sample(1,obs,FP2)
  Sample(1,ss,FP2)
EndTable

'Main Program
BeginProg

  Scan (30,sec,3,0)
    PanelTemp (PTemp,250)
    Battery (batt_volt)
    PortSet (1 ,1 )
    PortSet (2,0)
    Delay (0,9500,msec)
    VoltDiff (obs,1,0,1,1,0,_60Hz,1,0)
    PortSet (2 ,1 )
    Delay (0,800,msec)
    VoltDiff (ss,1,0,1,1,0,_60Hz,1,0)
    PortSet (1,0)
    CallTable(OBS500_analog)
  NextScan

  'blue wire -- drive high to open shutter
  'white wire selects obs (0) or ss (1)
  '6 secs (shutter open) + 3.5 secs
  '1 mV = 1 TU
  'white wire to +5 volts for ss meas
  'wait until meas is done

  'blue wire -- drive low to close shutter

EndProg
```

## B.4 Examples for High Sediment Loads

### B.4.1 Normally Open CR1000 Example

#### CRBasic Example B-4. Normally Open CR1000 Example

```
'CR1000 Series Datalogger
'OBS500 normally open

'In normally open mode the OBS500 can make measurement multiple times per minute but the wiper interval could be set
'to as low as a time or two a day. This mode is also beneficial where the power budget is critical since opening and
'closing the wiper consumes considerably more power than making the turbidity measurement.

'Declare Public Variables

Public OBS500(4)
Public TimeCounter
Public obsDatOpen(4),obsDatClose(4)

'Declare Other Variables
Alias OBS500(1) = turb_bs
Alias OBS500(2) = turb_ss
Alias OBS500(3) = tempC_obs500
Alias OBS500(4) = wet_dry
Alias obsDatOpen(1) = Open_counts 'Full movement of slider is about 20,000 counts. If it jams this # will be smaller
Alias obsDatOpen(2) = Open_Max_mA_cnts 'Number of times the shutter stops while opening because of max current
Alias obsDatOpen(3) = Open_slip 'Open timeout count. If the threads are stripped the slide will not move and this count will increase
Alias obsDatOpen(4) = Open_mA 'mA current of the motor
Alias obsDatClose(1) = Close_counts 'Full movement of slider is about 20,000 counts. If it jams this # will be smaller
Alias obsDatClose(2) = Close_Max_mA_cnts 'Number of times the shutter stops while opening because of max current
Alias obsDatClose(3) = Close_slip 'Open timeout count. If the threads are stripped the slide will not move and this count will increase
Alias obsDatClose(4) = Close_mA 'mA current of the motor

Units turb_bs = fbu
Units turb_ss = fnu
Units tempC_obs500 = degC
Units wet_dry = YesNo

'Define Data Tables
DataTable (Test,1,1000)
  DataInterval (0,5,Min,10)
  Sample (1,turb_bs,FP2)
  Sample (1,turb_ss,FP2)
EndTable

'Main Program
BeginProg

SDI12Recorder (obsDatOpen(),1,0,"M3!",1,0) 'Start with shutter open

Scan (1,Min,0,0)

  TimeCounter = TimeCounter + 1

  'Wipe at a slower interval than the scan interval

  If TimeCounter >= 60 Then 'This value, 60, will wipe once every 60 scan intervals. 60 minutes in this case
    SDI12Recorder (obsDatClose(),1,0,"M7!",1,0)
    SDI12Recorder (obsDatOpen(),1,0,"M3!",1,0)
    TimeCounter = 0
  EndIf

  'Read OBS500 each scan interval

  SDI12Recorder(OBS500(),1,0,"M4!",1,0) 'Measure without moving the wiper

  'Call Output Tables
  CallTable Test
NextScan
EndProg
```



## B.4.2 Cycle Shutter/Wiper for Each Measurement CR1000 Program

The following CRBasic program will:

- Open the shutter if closed, then make a measurement
- Make a measurement if open, then close

Shutter/wiper cycles will be cut by 50%. This will reduce wear and power consumption 50% but still leave the optics shuttered 50% of the time.

### CRBasic Example B-5. Cycle Shutter/Wiper for Each Measurement CR1000 Program

```
'CR1000 Series Datalogger
'OBS500 cycle shutter each measurement

'Declare Public Variables

Public OBS500(4)
Public obsDatOpen(4),obsDatClose(4)
Public Open

'Declare Other Variables
Alias OBS500(1) = turb_bs
Alias OBS500(2) = turb_ss
Alias OBS500(3) = tempC_obs500
Alias OBS500(4) = wet_dry
Alias obsDatOpen(1) = Open_counts 'Full movement of slider is about 20,000 counts. If it jams this # will be smaller
Alias obsDatOpen(2) = Open_Max_mA_cnts ' Number of times the shutter stops while opening because of max current
Alias obsDatOpen(3) = Open_slip 'Open timeout count. If the threads are stripped the slide will not move and this count will increase
Alias obsDatOpen(4) = Open_mA 'mA current of the motor
Alias obsDatClose(1) = Close_counts 'Full movement of slider is about 20,000 counts. If it jams this # will be smaller
Alias obsDatClose(2) = Close_Max_mA_cnts 'Number of times the shutter stops while opening because of max current
Alias obsDatClose(3) = Close_slip 'Open timeout count. If the threads are stripped the slide will not move and this count will increase
Alias obsDatClose(4) = Close_mA 'mA current of the motor

Units turb_bs = fbu
Units turb_ss = fnu
Units tempC_obs500 = degC
Units wet_dry = YesNo

'Define Data Tables
DataTable (Test,1,1000)
  DataInterval (0,5,Min,10)
  Sample (1,turb_bs,FP2)
  Sample (1,turb_ss,FP2)
EndTable

'Main Program
BeginProg

Scan (60,Sec,0,0)

  'If open make measurement and close. If closed, open then make measurement.

  If Open = 1 Then 'If open the make measurement, then close
    SDI12Recorder(OBS500(1),1,0,"M4!",1,0) 'Measure without moving the wiper
    SDI12Recorder (obsDatClose(1),1,0,"M7!",1,0) 'Close wiper
    Open = 0
  Else 'if closed
    SDI12Recorder (obsDatOpen(1),1,0,"M3!",1,0) 'Open wiper
    Delay (0,11,Sec)
    SDI12Recorder(OBS500(1),1,0,"M4!",1,0) 'Measure without moving the wiper
    Open = 1
  EndIf
  'Call Output Tables
  CallTable Test
NextScan
EndProg
```



# ***Appendix C. OBS500 Copper Sleeve Kit Installation***

---

1. Remove the Button Head Hex Screw as shown.



2. Slide the Copper Sleeve over the OBS500 and snap it into place.



3. Install the 4-40 x 1/4 SS Slot Head Screw.





# Appendix D. SDI-12 and RS-232 Measurement Commands for OS Version 1

---

OBS500 OS version 1 supports different commands than newer operation systems. TABLE D-1 shows the commands available for OS version 1. Use the **a!** SDI-12 command or use *DevConfig* to see the OS version downloaded to your OBS500. The OS version can be updated by using *DevConfig*.

TABLE D-1. SDI-12 and RS-232 Measurement Commands		
Commands	Process	Values Returned
<b>aM!</b> <b>aC!</b> a = address	Open Wiper Measure Close Send Data	obs (tu) ss (tu ) temperature (degc) wet dry (0=dry 1=wet)
<b>aM1!</b> <b>aC1!</b>	Open Wiper Measure Close Send Data	ratio (tu) temperature (degc) wet dry (0=dry 1=wet)
<b>aM2!</b> <b>aC2!</b>	Open Wiper Measure Close Send Data	obs (tu) ss (tu ) ratio (tu) temperature (degc) raw obs (volts) raw ss (volts) open current (ma) close current (ma) wet dry (0=dry 1=wet)
<b>aM3!</b> <b>aC3!</b>	Open Wiper Send Data	open wiper position count open max current count open timeout count open current (ma)
<b>aM4!</b> <b>aC4!</b>	Measure Send Data	obs (tu) ss (tu ) temperature (degc) wet dry (0=dry 1=wet)
<b>aM5!</b> <b>aC5!</b>	Measure Send Data	ratio (tu) temperature (degc) wet dry (0=dry 1=wet)

TABLE D-1. SDI-12 and RS-232 Measurement Commands		
Commands	Process	Values Returned
<b>aM6!</b> <b>aC6!</b>	Measure Send Data	obs (tu) ss (tu ) ratio (tu) temperature (degc) raw obs (volts) raw ss (volts) open current (ma) close current (ma) wet dry (0=dry 1=wet)
<b>aM7!</b> <b>aC7!</b>	Close Wiper Send Data	Close wiper position count Close max current count Close timeout count Close current (ma)
<b>aM8!</b> <b>aC8!</b>	Send Wiper Data	Open close total count Open wiper position count Open max current count Open timeout count Close wiper position count Close max current count Close timeout count
<b>aC9!</b>	Open Wiper Measure 100 Times Close Send Data	obs median obs mean obs standard deviation obs min obs max ss median ss mean ss standard deviation ss min ss max

**NOTE** With the SDI-12 concurrent measurements (**aCx!**), the datalogger does not request the data until the next interval hits. For example, if you have a 30-minute interval, you will not see the data for 30 minutes. There is not an equivalent **M** command to the **aC9!** command since the **M** command is limited to nine returned values.

As the measurement data is transferred between the probe and datalogger digitally, there are no offset errors incurred with increasing cable length as seen with analog sensors. However, with increasing cable length, there is still a point when the digital communications will break down, resulting in either no response or excessive SDI-12 retries and incorrect data due to noise problems. Using SDI-12 commands which add a CRC check (e.g., **aMC!**), can significantly improve incorrect data issues.



## Campbell Scientific Companies

---

**Campbell Scientific, Inc.**

815 West 1800 North  
Logan, Utah 84321  
UNITED STATES

[www.campbellsci.com](http://www.campbellsci.com) • [info@campbellsci.com](mailto:info@campbellsci.com)

**Campbell Scientific Canada Corp.**

14532 – 131 Avenue NW  
Edmonton AB T5L 4X4  
CANADA

[www.campbellsci.ca](http://www.campbellsci.ca) • [dataloggers@campbellsci.ca](mailto:dataloggers@campbellsci.ca)

**Campbell Scientific Africa Pty. Ltd.**

PO Box 2450  
Somerset West 7129  
SOUTH AFRICA

[www.campbellsci.co.za](http://www.campbellsci.co.za) • [cleroux@csafrica.co.za](mailto:cleroux@csafrica.co.za)

**Campbell Scientific Centro Caribe S.A.**

300 N Cementerio, Edificio Breller  
Santo Domingo, Heredia 40305  
COSTA RICA

[www.campbellsci.cc](http://www.campbellsci.cc) • [info@campbellsci.cc](mailto:info@campbellsci.cc)

**Campbell Scientific Southeast Asia Co., Ltd.**

877/22 Nirvana@Work, Rama 9 Road  
Suan Luang Subdistrict, Suan Luang District  
Bangkok 10250  
THAILAND

[www.campbellsci.asia](http://www.campbellsci.asia) • [info@campbellsci.asia](mailto:info@campbellsci.asia)

**Campbell Scientific Ltd.**

Campbell Park  
80 Hathern Road  
Shepshed, Loughborough LE12 9GX  
UNITED KINGDOM

[www.campbellsci.co.uk](http://www.campbellsci.co.uk) • [sales@campbellsci.co.uk](mailto:sales@campbellsci.co.uk)

**Campbell Scientific Australia Pty. Ltd.**

PO Box 8108  
Garbutt Post Shop QLD 4814  
AUSTRALIA

[www.campbellsci.com.au](http://www.campbellsci.com.au) • [info@campbellsci.com.au](mailto:info@campbellsci.com.au)

**Campbell Scientific Ltd.**

3 Avenue de la Division Leclerc  
92160 ANTONY  
FRANCE

[www.campbellsci.fr](http://www.campbellsci.fr) • [info@campbellsci.fr](mailto:info@campbellsci.fr)

**Campbell Scientific (Beijing) Co., Ltd.**

8B16, Floor 8 Tower B, Hanwei Plaza  
7 Guanghua Road  
Chaoyang, Beijing 100004  
P.R. CHINA

[www.campbellsci.com](http://www.campbellsci.com) • [info@campbellsci.com.cn](mailto:info@campbellsci.com.cn)

**Campbell Scientific Ltd.**

Fahrenheitstraße 13  
28359 Bremen  
GERMANY

[www.campbellsci.de](http://www.campbellsci.de) • [info@campbellsci.de](mailto:info@campbellsci.de)

**Campbell Scientific do Brasil Ltda.**

Rua Apinagés, nbr. 2018 – Perdizes  
CEP: 01258-00 – São Paulo – SP  
BRASIL

[www.campbellsci.com.br](http://www.campbellsci.com.br) • [vendas@campbellsci.com.br](mailto:vendas@campbellsci.com.br)

**Campbell Scientific Spain, S. L.**

Avda. Pompeu Fabra 7-9, local 1  
08024 Barcelona  
SPAIN

[www.campbellsci.es](http://www.campbellsci.es) • [info@campbellsci.es](mailto:info@campbellsci.es)

Please visit [www.campbellsci.com](http://www.campbellsci.com) to obtain contact information for your local US or international representative.