

INSTRUCTION MANUAL



PVS4100/4120/4150 Portable Samplers

Revision: 4/12



Copyright © 2011-2012
Campbell Scientific, Inc.

Warranty

The PVS4100/4120/4150 Portable Samplers are warranted for thirty-six (36) months subject to this limited warranty:

“PRODUCTS MANUFACTURED BY CAMPBELL SCIENTIFIC, INC. are warranted by Campbell Scientific, Inc. (“Campbell”) to be free from defects in materials and workmanship under normal use and service for twelve (12) months from date of shipment unless otherwise specified in the corresponding Campbell pricelist or product manual. Products not manufactured, but that are re-sold by Campbell, are warranted only to the limits extended by the original manufacturer. Batteries, fine-wire thermocouples, desiccant, and other consumables have no warranty. Campbell's obligation under this warranty is limited to repairing or replacing (at Campbell's option) defective products, which shall be the sole and exclusive remedy under this warranty. The customer shall assume all costs of removing, reinstalling, and shipping defective products to Campbell. Campbell will return such products by surface carrier prepaid within the continental United States of America. To all other locations, Campbell will return such products best way CIP (Port of Entry) INCOTERM® 2010, prepaid. This warranty shall not apply to any products which have been subjected to modification, misuse, neglect, improper service, accidents of nature, or shipping damage. This warranty is in lieu of all other warranties, expressed or implied. The warranty for installation services performed by Campbell such as programming to customer specifications, electrical connections to products manufactured by Campbell, and product specific training, is part of Campbell's product warranty. CAMPBELL EXPRESSLY DISCLAIMS AND EXCLUDES ANY IMPLIED WARRANTIES OF MERCHANTABILITY OR FITNESS FOR A PARTICULAR PURPOSE. Campbell is not liable for any special, indirect, incidental, and/or consequential damages.”

Assistance

Products may not be returned without prior authorization. The following contact information is for US and international customers residing in countries served by Campbell Scientific, Inc. directly. Affiliate companies handle repairs for customers within their territories. Please visit www.campbellsci.com to determine which Campbell Scientific company serves your country.

To obtain a Returned Materials Authorization (RMA), contact CAMPBELL SCIENTIFIC, INC., phone (435) 227-9000. After an applications engineer determines the nature of the problem, an RMA number will be issued. Please write this number clearly on the outside of the shipping container. Campbell Scientific's shipping address is:

CAMPBELL SCIENTIFIC, INC.

RMA# _____
815 West 1800 North
Logan, Utah 84321-1784

For all returns, the customer must fill out a "Statement of Product Cleanliness and Decontamination" form and comply with the requirements specified in it. The form is available from our web site at www.campbellsci.com/repair. A completed form must be either emailed to repair@campbellsci.com or faxed to (435) 227-9106. Campbell Scientific is unable to process any returns until we receive this form. If the form is not received within three days of product receipt or is incomplete, the product will be returned to the customer at the customer's expense. Campbell Scientific reserves the right to refuse service on products that were exposed to contaminants that may cause health or safety concerns for our employees.

PVS4100/4120/4150

Table of Contents

PDF viewers: These page numbers refer to the printed version of this document. Use the PDF reader bookmarks tab for links to specific sections.

1. Product Overview	1-1
1.1 Introduction	1-1
1.2 Features	1-2
1.2.1 PVS4100 and PVS4120 Sampler Features	1-2
1.2.2 PVS4150 Sampler Features	1-4
1.2.3 Sampler Vacuum System Features	1-6
1.2.4 Signal Panel	1-8
1.3 Specifications	1-9
1.3.1 PVS4100 Portable Sampler Specifications	1-9
1.3.2 PVS4120 Lightweight Portable Sampler Specifications	1-10
1.3.3 PVS4150 Ultra-Portable Sampler Specifications	1-11
1.3.4 Controller Specifications	1-12
1.3.5 Vacuum System Specifications	1-13
1.3.6 Sample Container Options	1-14
1.3.7 Composite and Discrete Overview	1-14
1.3.8 Sample Transport Velocity	1-15
1.3.8.1 Using Velocity to Calculate Purge Time	1-16
1.3.8.2 Horizontal/Vertical Combinations	1-16
1.3.9 Special Systems	1-17
1.3.9.1 5/8 Systems	1-17
1.3.9.2 MISA Systems – Teflon and Glass	1-17
1.4 Portable Sampler Model Selection Guide	1-18
2. Installation	2-1
2.1 Cabinet Positioning	2-1
2.2 Intake Hose	2-2
2.3 Sinkers / Strainers	2-2
2.4 Storage	2-2
2.5 Signal Wiring	2-3
2.6 Installation Checklist	2-4
3. Operation	3-1
3.1 Operating Sequence	3-1
3.1.1 Sampling Sequence	3-1
3.1.2 Line Voltage Failure	3-2
3.2 Operating Instructions	3-2
3.2.1 Sample Volume Adjustment	3-2
3.2.2 Liquid Sensing Rod	3-3
3.3 Battery	3-4
3.3.1 Battery: Operating and Backup (optional)	3-4
3.3.2 Battery: Microprocessor	3-5
3.4 Test Procedure	3-6
3.5 Troubleshooting	3-6

4. Maintenance	4-1
4.1 General Maintenance.....	4-1
4.2 Testing System Vacuum.....	4-1
5. Programming	5-1
5.1 General Programming.....	5-1
5.1.1 Guidelines.....	5-1
5.1.1.1 Flashing Text.....	5-1
5.1.1.2 Real Time Clock.....	5-1
5.1.1.3 Total Bottles.....	5-1
5.1.2 Touchpad Keys.....	5-2
5.1.3 General Terms.....	5-4
5.2 Quick Start Guide to Programming.....	5-6
5.2.1 Automatic Sampling Program.....	5-6
5.2.2 Taking a Manual Sample.....	5-7
5.2.3 Viewing Program Parameters.....	5-7
5.2.4 Setting Program Parameters Individually.....	5-8
5.3 Programming START DELAY.....	5-8
5.3.1 START DELAY Overview.....	5-8
5.3.2 START DELAY using Time/Day.....	5-9
5.3.3 START DELAY using Pulse Input.....	5-11
5.3.4 START DELAY using 4-20mA Input.....	5-12
5.3.5 START DELAY using External Contact.....	5-14
5.3.6 START DELAY using Level Control.....	5-15
5.4 Programming SAMPLE INITIATION.....	5-16
5.4.1 SAMPLE INITIATION Overview.....	5-16
5.4.2 SAMPLE INITIATION using Interval Time.....	5-17
5.4.3 SAMPLE INITIATION using Pulse Input.....	5-19
5.4.4 SAMPLE INITIATION using 4-20mA Input.....	5-20
5.4.5 SAMPLE INITIATION using External Contact.....	5-22
5.5 Programming PROGRAM TYPE.....	5-23
5.5.1 PROGRAM TYPE Overview.....	5-23
5.5.2 PROGRAM TYPE - Composite.....	5-24
5.5.3 PROGRAM TYPE - Daily Cycle.....	5-26
5.5.4 PROGRAM TYPE - Daily Cycle for Dual Station.....	5-27
5.5.5 PROGRAM TYPE - Consecutive.....	5-29
5.5.6 PROGRAM TYPE - Multi-Composite.....	5-31
5.5.7 PROGRAM TYPE - Timed Step.....	5-32
5.6 Programming OTHER OPTIONS.....	5-34
5.6.1 OTHER OPTIONS Overview.....	5-34
5.6.2 OTHER OPTIONS - Clock.....	5-36
5.6.3 OTHER OPTIONS - Purge Time.....	5-37
5.6.4 OTHER OPTIONS - Pinch Valve.....	5-39
5.6.5 OTHER OPTIONS - Fault Shutdown.....	5-40
5.7 Viewing Information.....	5-42
5.7.1 Viewing Programmed Information.....	5-42
5.7.2 Viewing Generated Information.....	5-44

Appendices

A. Principles of Operation..... A-1

B. Parts List..... B-1

C. Programming 4-20mA for Flow Proportional Sampling C-1

List of Figures

1-1. Highlights of the PVS4100 and PVS4120 Samplers 1-2

1-2. Highlights of the PVS4150 Sampler..... 1-4

1-3. Diagram of the PVS Vacuum System 1-6

2-1. Sampler Installation..... 2-1

2-2. External Signal Cable for PVS4100 and PVS4120 2-3

3-1. Battery Performance Curve 3-4

List of Tables

1-1. PVS4100 and PVS4120 Sampler Features 1-3

1-2. PVS4150 Sampler Features 1-5

1-3. Vacuum System Features 1-7

1-4. PVS4100 Sampler Specifications 1-9

1-5. PVS4120 Sampler Specifications 1-10

1-6. PVS4150 Sampler Specifications 1-11

1-7. Controller Specifications 1-12

1-8. Vacuum System Specifications 1-13

1-9. Sample Container Options – PVS4100 and PVS4120..... 1-14

1-10. Sample Container Options – PVS4150..... 1-14

1-11. Vertical Velocity 1-15

1-12. Horizontal Velocity 1-16

1-13. MISA System Changes..... 1-17

5-1. Touchpad Button Descriptions 5-2

B-1. PVS Replacement Parts B-1

Section 1. Product Overview

1.1 Introduction

The PVS4100, PVS4120 and PVS4150 Portable Samplers are automatic liquid samplers for water and wastewater applications. PVS Samplers are capable of gathering fluid automatically from a variety of sources, including containers, open channels, sewers, pipes, and any open source of water.

Samplers are designed for reliable unattended sample collection. Portable units are capable of keeping the temperature of the deposited liquid at 4°C (39.2°F) for up to 24 hours using crushed ice or ice packs until the samples are gathered and brought back to the laboratory for analysis.

There are a variety of methods for depositing samples. Composite sampling is used where samples are deposited, over time, into one container. Discrete systems are used when multiple bottles are needed. These are also called “sequential” systems, and involve a stepper with distributor arm which dispenses the liquid into a bottle, then moves to the next bottle.

Operating temperature for portable samplers is 10°C to 50°C (50°F to 122°F), adaptable down to 0°C (32°F) upon request.

Samples can be triggered by a variety of means. The internal clock on the controller can be set to sample based on time/day (e.g. sample every hour). There are also a variety of external inputs that can be connected to control sampling using the optional external signal cable. Pulse count is useful for sampling after a certain number of pulses have been reached (e.g. using a rain gauge to trigger sampling). The 4-20 mA option is useful for flow-based sampling (e.g. using a flow meter to trigger sampling after a certain volume of water has passed by). External contact is used to control the sampler from another data logger or PLC, and is useful when full external control is desired. Level control is the option to choose when the application has starts and stops (e.g. using a float switch to trigger sampling when water is present, then stop sampling when the water drops below the set level).

When sampling is initiated, liquid travels through the intake tube into the metering chamber. The amount of water taken is set mechanically using the liquid sensing rod and the volume control tube, which means sample accuracy is precise every time, usually within +/- 2% or +/- 2ml.

Once the pre-set amount has been reached, all excess liquid is purged from the system, and the sample is dropped into a container. Sample containers range from 500 ml (500 cc or 2 cup) wedges in discrete systems, to 9 liters (2.3 Gallon) containers for composite systems.

Intake tube is offered in either 3/8” (9.5 mm) ID or 5/8” (15.9 mm) ID, and can be either Nylon-reinforced PVC or Teflon-lined PVC. Transport velocity varies depending on height and distance being sampled. For most situations the sampler pulls at over 1.5 m/s (5 ft/sec). For an in-depth speed chart, refer to Section 1.3.7 Sample Transport Velocity on page 1-15.

1.2 Features

1.2.1 PVS4100 and PVS4120 Sampler Features

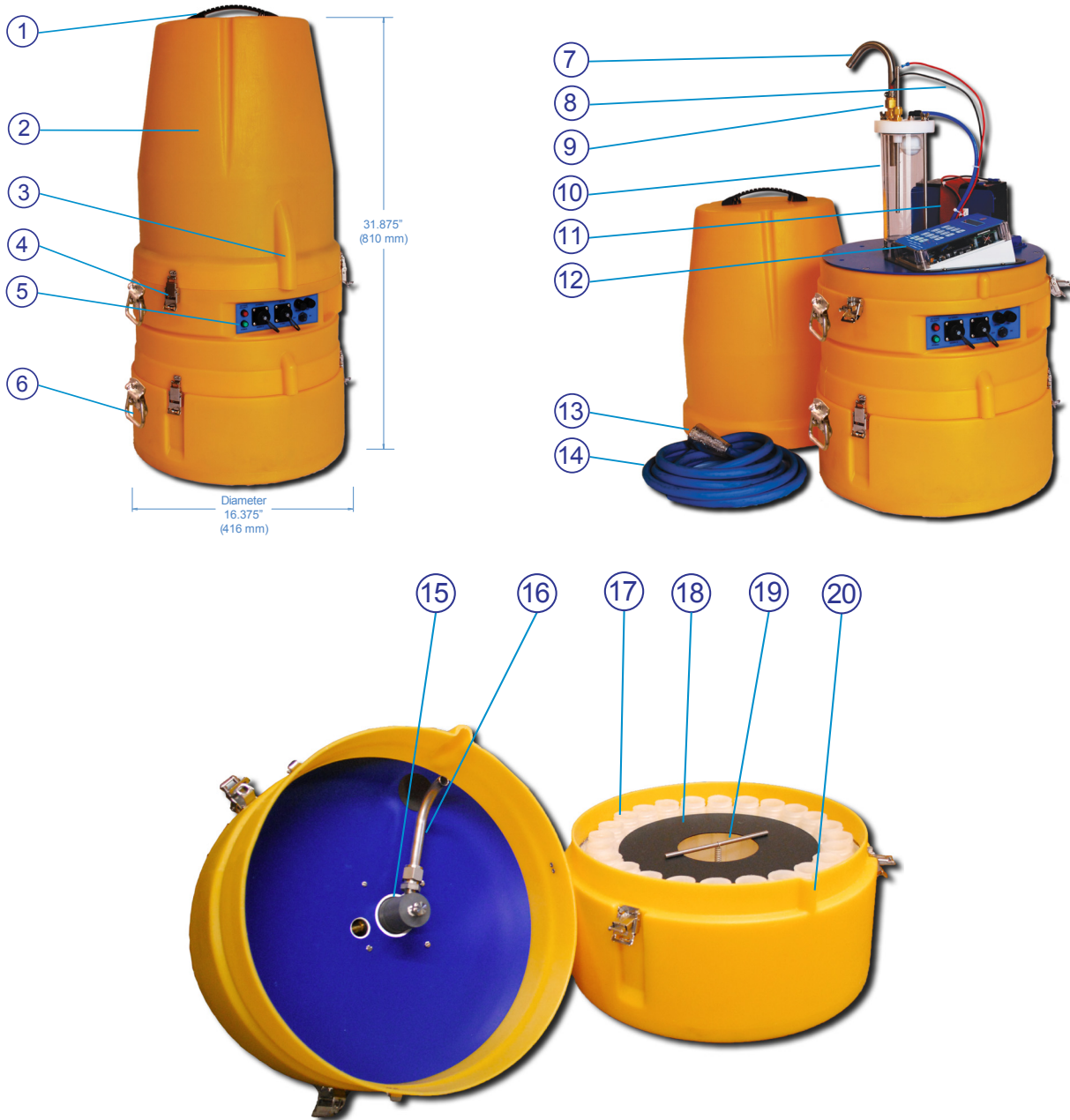

FIGURE 1-1. Highlights of the PVS4100 and PVS4120 Samplers

TABLE 1-1. PVS4100 and PVS4120 Sampler Features

Number	Item	Description
1	Top Handle	For easy transport.
2	Enclosure	Molded medium-density linear polyethylene, 3 piece construction. Provides protection from wind and rain. Not submersible.
3	Intake Hose Slot	The hose must lie in the slot for lid to close properly. A secondary notch is provided for lining up the sampler properly.
4	Clasps	There are three clasps for each section, for a total of six. The clasps have ringlets for attaching a suspension harness.
5	Signal Panel	Red Light: Reverse Polarity, Green Light: Power Left Plug: External Signals (to be used with optional signal cable) Right Plug: Power – 120VAC or 12VDC Left Fuse: 120VAC, Right Fuse: 12VDC Toggle Switch: Power On/Off For detailed chart, see page 1-8.
6	Folding Handles	For easy transport.
7	Intake Hose Connection	The volume control tube is where the intake hose is connected to the sampler. This stainless steel tube is raised or lowered manually using fitting to set the sample volume (<i>see</i> FIGURE 1-3 on page 1-6).
8	Wiring	Connects electricity to the rods for sampling. When replacing metering chamber, these rods can be easily disconnected.
9	Nuts to adjust volume	To adjust sample volume, twist top nut while holding bottom nut in place. Hand tightening works for many applications, but a wrench is advised.
10	Metering Chamber	This chamber is where the sample liquid is drawn into before dropping into the final container. The rods inside are raised and lowered to the sample volume desired.
11	Battery	Standard on all samplers. The PVS4100 battery is 15 lbs, 17AH. The PVS4120 battery (shown) is 4 lbs, 7 AH.
12	Multi-Function Input Controller	This is where sampler is controlled and programmed.
13	Sinker. Optional Strainer.	Keeps the end of the intake tube in the source liquid. Optional strainer can raise collection point above sinker.
14	Intake Hose	Standard samplers come with 25 Feet of 3/8" ID PVC tube.
15	Stepper Assembly	Moves the distributor arm for multiple bottle configurations. This is not present on composite (single bottle) samplers.
16	Distributor Arm	Dispenses liquid into bottles. Moves to next bottle after sampling. On composite (single bottle) samplers, this is replaced with discharge tube.
17	Sample Container(s)	The container(s) that the sample is deposited in can be made from a variety of materials, shapes, and sizes. In discrete samplers, there is a distributor arm that deposits samples into multiple containers.
18	Retaining Plate	Holds sample bottles down tightly (discrete samplers only).
19	T-Bar	This bar is needed to hold the retaining plate down. It is imperative that the bottles do not lift up even a little bit, as they can interfere with the mobility of the distributor arm (discrete samplers only).
20	Bottle-Guide Notch	This notch is the location of bottle number one. It lines up the middle section of the sampler so that the distributor arm can be placed at the same location.

1.2.2 PVS4150 Sampler Features



FIGURE 1-2. Highlights of the PVS4150 Sampler

TABLE 1-2. PVS4150 Sampler Features

Number	Item	Description
1	Signal Panel	Green Light: Integral Battery Charging (AC power connected) Red Light: External Battery Reverse Polarity Toggle Switch: Power On/Off Plug: AC power (coupled with optional signal cable when supplied).
2	Volume Control Tube	This stainless steel tube is raised or lowered manually using the fitting to set the sample volume (<i>see</i> FIGURE 1-3 <i>on</i> page 1-6).
3	Multi-Function Input Controller	This is where sampler is controlled and programmed.
4	Metering Chamber	This chamber is where the sample liquid is drawn into before dropping into the final container. The rods inside are raised and lowered to the sample volume desired.
5	Pinch Valve	This valve shuts during sampling, and then releases once desired liquid has entered the chamber.
6	Side Plug	Attached to the side of the door with Velcro. During transport of full sample container, this plug screws into the hole where the discharge tube enters the bottle so that the bottle can be carried upright by its handle.
7	Sample Container	The 2.3 Gal (9L) container that the sample is deposited into is HDPE, or can be upgraded to PP. Container has a side notch with plug for discharge tube to enter.
8	Latches	4 Press-and-Pull Latches provide airtight seal of sampler for transport. Sampler can operate with door open or closed.
9	Cavity Space for Cooling Pack	This space fits one large Zero-Pak cooling pack, to keep sample cooled for 24 hours.
10	Quick Connectors	Optional connectors for quick connecting and disconnecting.
11	Intake Hose Connection	Intake hose is connected to volume control tube in the absence of quick connectors.
12	LED Indicator Lights	Green light: Power On/Sampling. Red light: Fault.
13	Enclosure	Hardigg HPX® high performance resin. Enclosure is fully watertight and submersible, depending on options (check with factory).
14	Intake Hose	Standard samplers come with 25 Feet of 3/8" ID PVC tube.
15	Sinker. Optional Strainer.	Keeps the end of the intake tube in the source liquid. Optional strainer can raise collection point above sinker.
16	Telescoping Handle	Retractable handle slides up and down for easy transport by pressing in the small lever on the right side.
17	Side Handles	Four durable soft-grip handles, one on each side, can be folded up or down.
18	Pressure Gauge	Optional gauge on the side of the enclosure (not shown). This is helpful for knowing what stage the sampler is at when sampling with the door closed.
19	Wheels	Two wheels for rolling on smooth surfaces.

1.2.3 Sampler Vacuum System Features

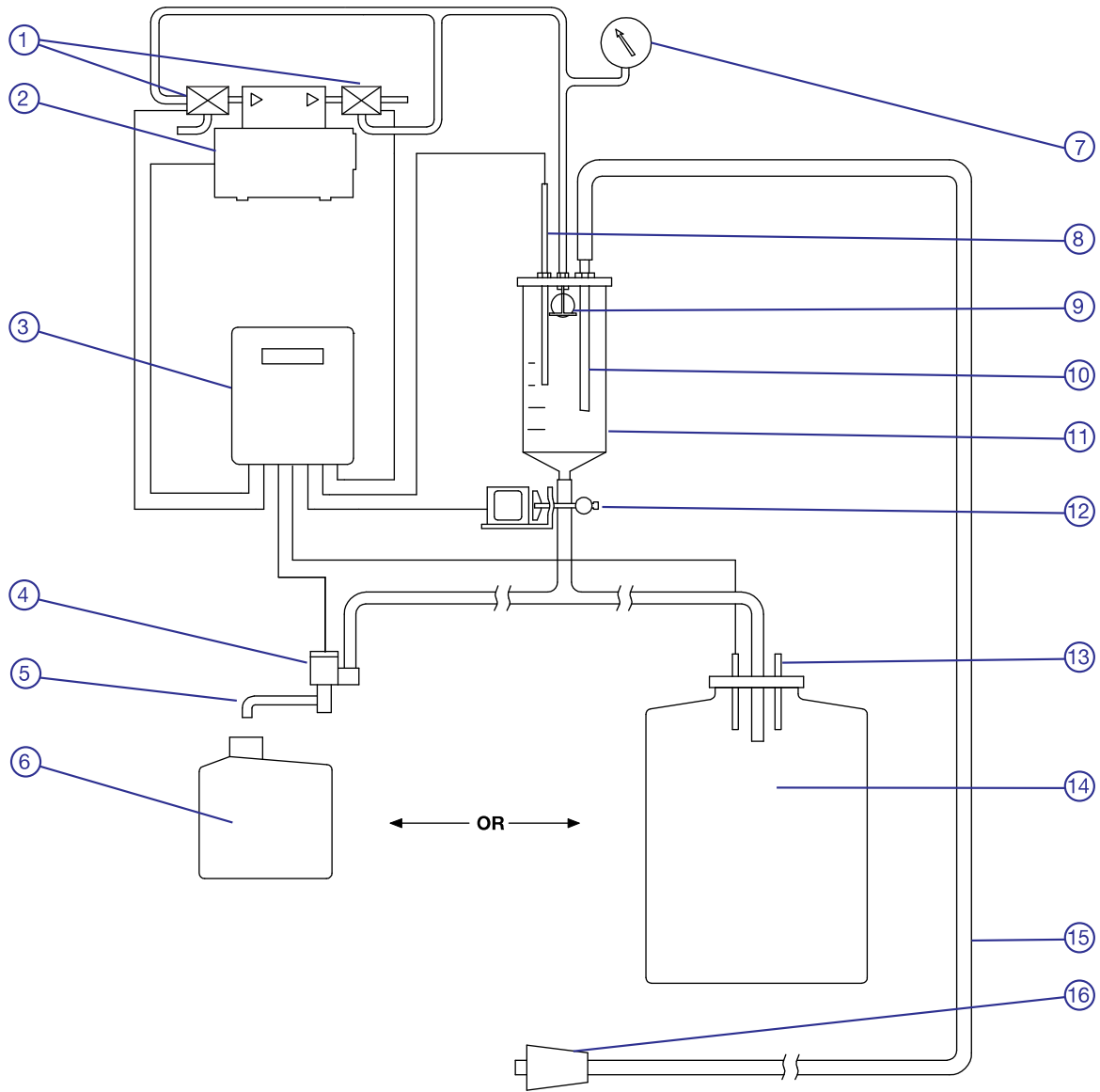

FIGURE 1-3. Diagram of the PVS Vacuum System

TABLE 1-3. Vacuum System Features

Number	Item	Description
1	Solenoid Valves	Control the air flow from pump to sampler, either purging or sucking.
2	Pump	Located behind a sheet of metal, the pump does not come into contact with any liquid whatsoever. It does all the drawing and purging through using a vacuum and compressor.
3	Touchpad Controller	Controls sampler program and offers status feedback on LCD.
4	Sample Distributor	Rotates distributor arm between multiple discrete containers.
5	Distributor Arm	Dispenses liquid from metering chamber into discrete container.
6	Discrete Sample Containers	Multiple containers, always in a quantity divisible into 24 (PVS4100 and PVS4120 only).
7	Pressure Gauge	Visually describes sampling process in terms of vacuum/pressure. Useful for troubleshooting a plugged/kinked line, or signals leaks. Optional (PVS4150 only).
8	Liquid Sensing Rod	This rod must remain <i>above</i> the volume control tube. When the sample liquid comes into contact with the two rods it signals the controller to stop sampling and begin purging.
9	Barrier Valve	Prevents metering chamber overflow in case the liquid sensing rod fails (e.g. completely coated with oils/grease).
10	Volume Control Tube	Mechanically set the volume required for sample by using a wrench on the fitting at the base of this stainless steel tube.
11	Metering Chamber	Sample is drawn into chamber up to level set by volume control tube, then line is purged, followed by dropping sample into containers. Metering Chambers come in glass or acrylic, from 250cc to 500cc.
12	Pinch Valve	This valve shuts during sampling, then opens during sampling to drop sample into container, then closes to purge hose.
13	Cap with “Container Full” Shut-off	Optional cap contains Overflow Protection Probes which signal the sampler to halt when container is full. Can be installed in maximum two containers, or into a discrete bottle tray.
14	Composite Sample Container	A single container to hold sample liquid.
15	Intake Hose	Standard samplers come with 25 Feet of 3/8” ID PVC tube.
16	Sinker. Optional Strainer.	Keeps the end of the intake tube in the source liquid. Optional strainer can raise collection point above sinker.

1.2.4 Signal Panel

PVS4100 and PVS4120

Red Light: Reverse Polarity, Green Light: Power
Left Plug: External Signals (to be used with optional signal cable)
Right Plug: Power – 120VAC or 12VDC
Left Fuse: 120VAC, Right Fuse: 12VDC
Toggle Switch: Power On/Off

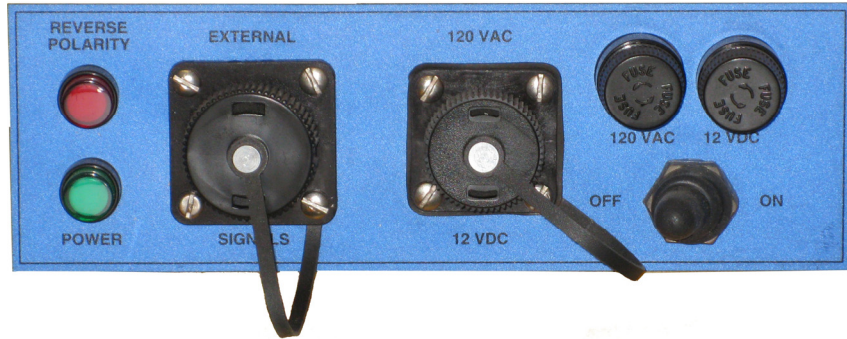

PVS4150

Green Light: Integral Battery Charging (AC power connected)
Red Light: External Battery Reverse Polarity
Toggle Switch: Power On/Off
Plug: AC power (coupled with optional signal cable when supplied).



1.3 Specifications

1.3.1 PVS4100 Portable Sampler Specifications

TABLE 1-4. PVS4100 Sampler Specifications	
Dimensions	Height: 809 mm (31.875 in) Diameter: 428 mm (16.85 in) Extended Base: Height: 962 mm (37.875 in) Diameter: 428 mm (16.85 in)
Weight (without battery)	11.8 kg (26 lbs)
Enclosure	Molded medium density linear polyethylene, 3 piece construction, all SS fittings. Protection Rating: IP 55, Dust protection, water jets.
Power Requirements	Sampler: DC Output: 13.6V, 10A. AC Input: 88-264VAC, 50/60Hz, 2.5A (max 3A) Integral Battery: 12VDC, 17AH, 15 lbs. External Receptacle: 12 VDC. Optional AC only model available (no battery).
Cooling System	Insulated container wall. Cavity space for ice.
Operating Temperature	Standard: 10°C to 50°C (50°F to 122°F) * Can be modified to operate down to 0°C (32°F) upon request.
Storage Temperature	-30°C to +60°C (-22°F to +140°F)

1.3.2 PVS4120 Lightweight Portable Sampler Specifications

TABLE 1-5. PVS4120 Sampler Specifications	
Dimensions	Height: 31.875 in (809 mm) Diameter: 16.85 in (428 mm) Extended Base: Height: 37.875 in (962 mm) Diameter: 16.85 in (428 mm)
Weight (without battery)	10.4 kg [23 lbs]
Enclosure	Molded medium density linear polyethylene, 3 piece construction, all SS fittings. Protection Rating: IP 55, Dust protection, water jets.
Power Requirements	Integral Battery: 12 VDC, 7 AH, 4 lbs. External Receptacle, 12 VDC. External Charger for 115VAC (optional up to 240VAC). Optional 120VAC/12VDC power supply with external battery charger.
Cooling System	Insulated container wall. Cavity space for ice.
Operating Temperature	Standard: 10°C to 50°C (50°F to 122°F) * Can be modified to operate down to 0°C (32°F) upon request.
Storage Temperature	-30°C to +60°C (-22°F to +140°F)

1.3.3 PVS4150 Ultra-Portable Sampler Specifications

TABLE 1-6. PVS4150 Sampler Specifications	
Dimensions	H: 24.6" x W: 19.7" x D: 14.4" [H: 625mm x W: 500mm x D: 366mm]
Weight (without battery)	35.5 lbs [16.1 kg]
Enclosure	HPX high performance resin. Press & Pull latches, and soft-grip handles. Protection Rating: IP 67, Dust-tight, water-tight (depending on options chosen).
Power Requirements	Integral Battery: 12 VDC, 7 AH, 4 lbs. External Charger for 115VAC (optional up to 240VAC).
Cooling System	Cavity space for two Zero-Pack (#12396).
Operating Temperature	Standard: 10°C to 50°C (50°F to 122°F) * Can be modified to operate down to 0°C (32°F) upon request.
Storage Temperature	-30°C to +60°C (-22°F to +140°F)

1.3.4 Controller Specifications

TABLE 1-7. Controller Specifications

Feature	Function	Capability	
START DELAY	Disabled	No start delay.	
	Time/Day	Adjustable, up to 1 week in advance.	
	Pulse Count	Adjustable, up to 9,999,999.	
	4-20mA	Adjustable, up to 9,999,999 (4-20mA = 0-100 Pulses/min).	
	External Contact	Momentary, 25 millisecond dry contact closure.	
SAMPLE INITIATION	Level Control	Adjustable up to 99 second contact duration.	
	Disabled	No sample initiation.	
	Interval Time	Adjustable up to 999 hours, 99 minutes	
	Pulse Count	Adjustable, up to 9,999,999.	
	4-20mA	Adjustable, up to 9,999,999 (4-20mA = 0-100 Pulses/min).	
PROGRAM TYPE	External Contact	Momentary, 25 millisecond dry contact closure.	
	Composite	Terminate after up to 9,999,999 samples.	
	Multi-Composite	Adjustable, up to 99 cycles per bottle.	
	Consecutive	Adjustable, up to 9 bottles per cycle.	
	Daily Cycle	Adjustable, up to 9 bottles per day.	
CLOCK	Timed Step	Adjustable, up to 99 hours, 99 minutes per step.	
	Real Time Clock	Real time operating system.	
	PINCH VALVE	Sample release	Adjustable, normally open / normally closed.
	PURGE CYCLE	Draw and purge time	Adjustable, 1 to 99 seconds.
	SUCTION CYCLE	Variable	Adjusts automatically to double the value of the purge time setting or until liquid contacts level electrode in metering chamber.
Vacuum		System pressure range is -14 psi to +20 psi, which can be shown on the Optional Pressure Gauge.	
ALARM OUTPUTS	Independent	Container Full (Latched. Any key resets. NPN*)	
		Sample Fault (Latched. Any key resets. NPN*)	
		Cycle Abandoned (Pulsed. NPN*)	
		<i>*NPN (sinking) – see Technical Appendix for details.</i>	
STATUS OUTPUTS	Independent	Sample Taken (DC relay driver, sinking)	
DIRECT FUNCTION KEYS	Manual Sample	Samples manually when pressed twice. Does not interrupt program.	
	Manual Purge	Purges system during second press as long as button is pressed.	
	Manual Bottle Advance	Moves distributor arm to next bottle.	
	Restart	Re-initiates program when pressed twice.	
AVAILABLE DISPLAYS	Real-Time Clock		
	Process Timing	Elapsed, remaining.	
	Process Totals		
	Pulse Counting	Internal/external.	
	Event Response	With time stamp.	
AUTOMATIC DISPLAYS	Multi-Level Descriptions		
	Flashing Text		
	Container Full	Sample program complete.	
	Fault	Program not completed.	
	Power Interrupt – Program Resumed		
	Alternating Time Stamp		
	Cycle(s) Abandoned		

1.3.5 Vacuum System Specifications

TABLE 1-8. Vacuum System Specifications	
Feature	Description
Switches	Run/Off (SPST Toggle).
Sample Volume	Adjustable, 50cc to 500cc [PVS4100 and PVS4120] Adjustable, 50cc to 250cc [PVS4150]
Sample Transport Velocity	PVS4100: Minimum of 3 ft/sec at 20 ft of lift (3/8" ID intake line). PVS4100: Minimum of 3 ft/sec at 16 ft of lift (5/8" ID intake line). PVS4100: Maximum Vertical 27.5 ft. PVS4120 and PVS4150: Minimum of 3 ft/sec at 13 ft of lift. PVS4120 and PVS4150: Maximum Vertical: 18 ft For complete charts, see page 1-15.
Metering Chamber	500cc capacity, clear acrylic, calibrated in 100cc's. 500cc capacity, glass (Pyrex), calibrated in 100cc's. [OPTIONAL] 250cc capacity, clear acrylic, calibrated in 50cc's. [PVS4150]
Metering Chamber Cover	Nylon Reinforced Teflon Top. [OPTIONAL]
Volume Control Tube	316 Stainless Steel
Metering Chamber Level Electrode	316 Stainless Steel
Intake Hose	Nylon-Reinforced PVC, 3/8" ID (standard 25 ft with sinker) Nylon-Reinforced PVC, 5/8" ID [OPTIONAL] Teflon-lined Tygon, 1/2" ID [OPTIONAL] Teflon-lined Tygon, 3/4" ID [OPTIONAL]
Discharge Hose	Latex, 3/8" ID Latex, 5/8" ID [OPTIONAL] Silicone, 3/8" ID [OPTIONAL] Silicone, 5/8" ID [OPTIONAL]
Sinker/Strainer	Lead Sinker Stainless Steel Sinker/Strainer [OPTIONAL] Stainless Steel Sinker [OPTIONAL]

1.3.6 Sample Container Options

TABLE 1-9. Sample Container Options – PVS4100 and PVS4120	
Feature	Description
Composite (single) containers	9 liter (2.3 US Gal) high density polyethylene (HDPE) 9 liter (2.3 US Gal) polypropylene (PP) 10 liter (2.5 US Gal) Glass <i>[with extended base]</i>
Discrete (multiple) containers	500cc (0.5 L) Wedges (PP) [24 bottles] 500cc (0.5 L) Wedges (PP) [24 bottles] <i>[with extended base]</i> 1 liter Glass [8 bottles] <i>[removable bottle tray c/w handles]</i> 1 liter high density polyethylene (HDPE) [8 bottles]

TABLE 1-10. Sample Container Options – PVS4150	
Feature	Description
Composite (single) containers	9 liter (2.3 US Gal) high density polyethylene (HDPE) 9 liter (2.3 US Gal) polypropylene (PP)

1.3.7 Composite and Discrete Overview

Discrete Sampling (PVS4100 and PVS4120 only) is sampling wherein samples are taken into more than one container. Inside of the cooling chamber is a stepper assembly which revolves 360° and delivers samples into separate containers, ranging from 8 to 24 bottles. Discrete sampling is beneficial in situations where change over time needs to be measured, such as measuring different water characteristics over 24 hours. Labs and monitoring personnel tend to rely on discrete portable sampling.



Composite Sampling is for drawing water samples into one large container. This is the simplest way of taking samples and typical for most situations where a sampler is set up to measure effluent in one location. It is also significantly less expensive than discrete sampling.



1.3.8 Sample Transport Velocity

TABLE 1-11. Vertical Velocity

	0'	5'	10'	15'	18'	20'	22'	25'	27'	28'	Height
3/8" ID Large pump (BVS 4300, CVS 4200, PVS4100)	7.1	7.1	6.0	5	4.4	4.1	3.6	3	2.6	0	Ft/sec
3/8" ID Small pump (PVS4120, PVS4150)	5.1	4.7	3.6	2.7	1.6	0					
5/8" ID Large pump	5	4.6	3.9	3.1	2.7	1.8	0				

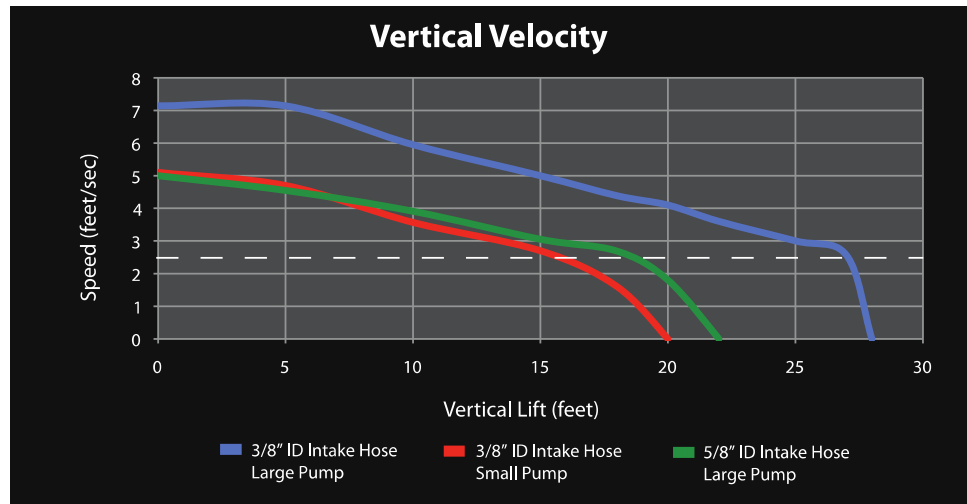
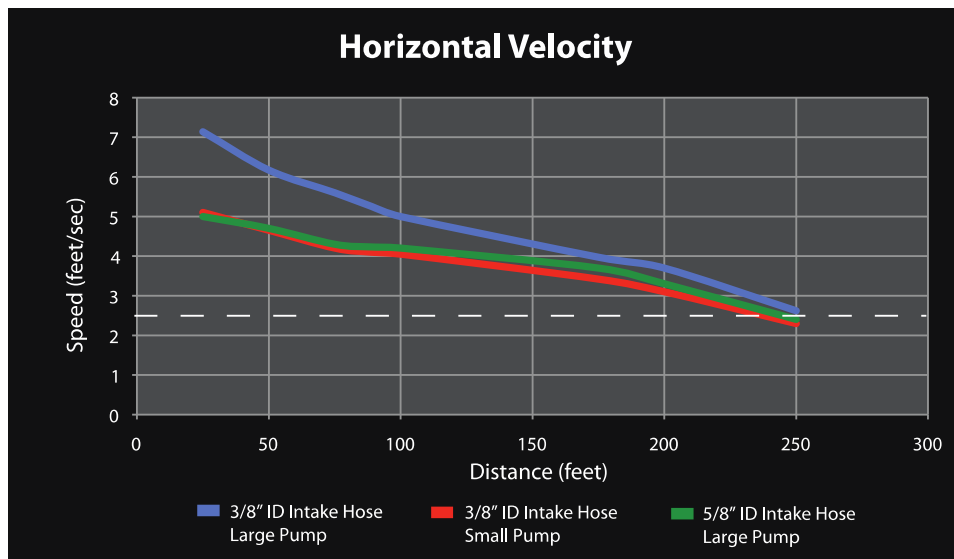

TABLE 1-12. Horizontal Velocity

	25'	50'	75'	100'	175'	200'	250'	Distance
3/8" ID Large pump (BVS 4300, CVS 4200, PVS4100)	7.1	6.2	5.6	5.0	4.0	3.7	2.6	Ft/sec
3/8" ID Small pump (PVS4120, PVS4150)	5.1	4.7	4.2	4.1	3.4	3.1	2.3	
5/8" ID Large pump	5.0	4.7	4.3	4.2	3.7	3.3	2.4	



1.3.8.1 Using Velocity to Calculate Purge Time

Purge time of the sampler needs to be programmed based on the length of hose and the velocity at which the liquid will travel through the hose. The formula is $l/v = p$ (length / velocity = min. purge time). Adding a few second to the purge time is recommended to ensure the line is fully cleared of any obstructions.

Example: 100 ft of hose, at 5 ft/sec, requires a minimum 20 second purge time. $100 / 5 = 20$ seconds. The number input for purge time should be a minimum of 20, but preferably 24.

Standard purge time for 25 ft of intake tube is 10 seconds. Although a standard 25 ft hose will sample in less than 4 seconds, 10 seconds is the minimum recommended for proper clearing of the line.

1.3.8.2 Horizontal/Vertical Combinations

The velocity charts above measure only horizontal or only vertical. Most applications will have combinations of both. With 200 feet of intake tubing, PVS Samplers are capable of drawing a sample above 2 ft/sec at 20 feet of vertical. At 23 feet of vertical with 200 feet of intake tubing, sampling may or may not be successful, depending on altitude and other factors. For more

detailed information for your specific application, please contact a Campbell Scientific applications engineer.

1.3.9 Special Systems

1.3.9.1 5/8 Systems

In applications with large particles or materials in the source liquid, a 5/8" ID system will help prevent clogging. The added diameter adds 66% more volume to the entire system. As of 2010, both composite and discrete samplers are available in 5/8". Smaller pump systems (PVS4120) have minimal capacity running the larger volume of the 5/8" ID so the larger pump systems (PVS4100) are recommended.

For a sampler to increase to a 5/8" ID, the following parts and components are changed to allow for more volume: intake tube, volume control tube, all fittings, metering chamber, metering chamber lid, discharge tube, sample container cover, sinker or strainer, and the distributor assembly (for discrete models).

1.3.9.2 MISA Systems – Teflon and Glass

In applications wherein the water sample must be prevented from coming into contact with any plastics, a MISA system is recommended. For example, when testing for acid/base/neutral extractable organics and pesticides, the MISA system will keep the final sample clean from any contaminants.

MISA stands for "Municipal/Industrial Strategy for Abatement," and includes changing all "wetted" components of the sampling system, i.e., everything that comes in contact with the final sample. The chart below outlines the key changes made to the sampler for a MISA system.

TABLE 1-13. MISA System Changes

Component	Standard Material	MISA System Material
Intake Tube	PVC	Teflon-Lined PVC
Sinker/Strainer	Lead Sinker	Stainless Steel Sinker/Strainer
Fittings	Brass	Stainless Steel
Metering Chamber	Acrylic	Pyrex
Metering Chamber Cover	Delrin	Teflon with Steel Bracing Ring
Discharge Tube	Latex	Silicone
Sample Container(s)	HDPE (or PP)	Glass
O-Rings	Buna-N (or Viton)	Silicone

1.4 Portable Sampler Model Selection Guide

PVS Samplers come in a variety of models designed for variations in weight, pump strength, battery, larger intake hose (5/8" ID), ease-of-transport, fitting in manholes, discrete or composite sampling, protection rating for dust and water, signal options, and budgets.



**Pump Differences in Samplers:
Velocity at Vertical Lift**

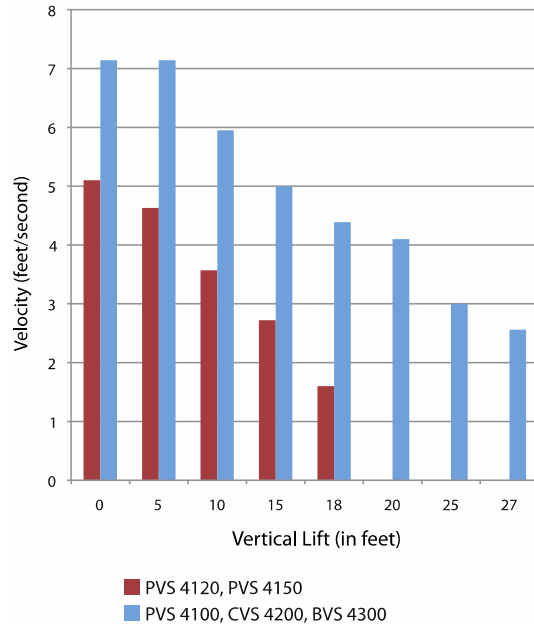

	Pump	Weight (without battery)	Battery*	5/8" ID Capability	Ease-of-transport	Discrete Sampling Capability	Manhole Fit Capability	Protection Rating	Signal Options
PVS 4100	Large (32-01-01)	26 Lbs 11.8kg	168 hours, 12 VDC, 17AH (15 Lbs), Sealed Lead-Acid	YES	Top handle, folding side handles, optional hand cart	Yes	YES	IP 55 Dust-protection, Water Jets	Advanced CAT-5 Cable
PVS 4120	Small (32-01-40)	23 Lbs 10.4kg	85 hours, 12 VDC, 7AH (4 Lbs), Sealed Lead-Acid	YES (limited)	Top handle, folding side handles, optional hand cart	Yes	YES	IP 55 Dust-protection, Water Jets	Advanced CAT-5 Cable
PVS 4150	Small (32-01-40)	35.5 Lbs 16.1kg	85 hours, 12 VDC, 7AH (4 Lbs), Sealed Lead-Acid	NO	Handles on all 4 sides, wheels, telescoping handle	No	NO	IP 67 Dust-tight, Water-tight	Simple Cable (less options)

* Battery times are how long sampler will last when fully charged, based on composite sampling, once per hour, with 10 second purge time. Note, on the 4120 the larger battery coupled with a small pump would last significantly longer than any of the times on this chart.

Section 2. Installation

2.1 Cabinet Positioning

Place the sampler on a level surface as close as practical to the sample source. Refer to the speed charts for maximum expected lift and draw. Manhole installation may require 3-point suspension harness.

Sampler must be located above sample source, or liquid will flood the machine. For situations where this is not possible, please contact a Campbell Scientific application engineer for solutions on pressurized sources.

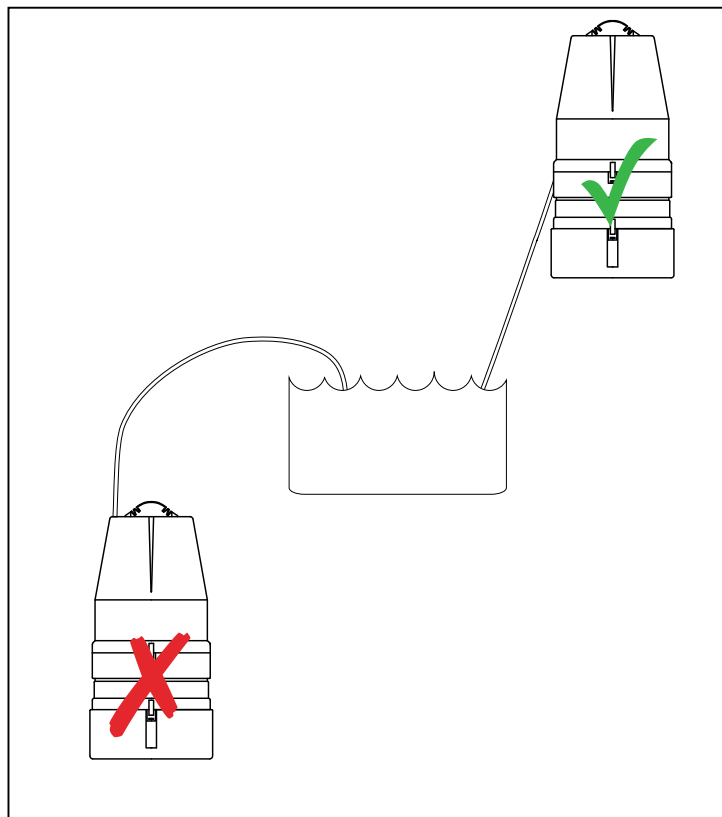

FIGURE 2-1. Sampler Installation

2.2 Intake Hose

Ensure the intake hose is submerged at all times throughout different flow velocities.

CAUTION

Twenty-five feet of intake hose is provided with the sampler. Shortening the hose is *not* recommended since this length of hose provides sufficient back pressure to the metering chamber, allowing the pump to efficiently expel all solids into the sampler container. Coil any excess intake hose in a manner to provide natural drainage away from the sampler. To install intake hose, heat the end in hot water and slip over volume control tube. Secure with hose clamp provided.

Sample line should be routed so that it has a near continuous slope from the sampler to the source liquid. This will help keep the sample line cleared and fully drained. All excess line should be coiled neatly and without any vertical loops.

2.3 Sinker / Strainer

Sinker or sinker/strainer is intended to keep sample line fully submerged in the source liquid. A sinker/strainer should be used in situations with material that clogs up a normal sinker, or where the standard sinker could stir up bottom sediment.



Lead Sinker: SAM-23-28-01



Stainless Steel Sinker/Strainer: SAM-23-28-11

2.4 Storage

If the sampler is not to be used for an extended period of time, store the unit in an upright position in a warm, dry location. If the unit has an integral battery, *recharge the unit* prior to storage.

Acceptable storage temperature: -30°C to +60°C (-22°F to +140°F)

2.5 Signal Wiring

External input capabilities of the sampler are implemented by the use of an optional external signal cable plugged into an external receptacle on the side of the sampler. External inputs of different types can be used by choosing the appropriate pair of wires in the cable.

On the PVS4150 the signal cable is combined with the AC Power cable, thus limiting the number of connections possible.



FIGURE 2-2. External Signal Cable for PVS4100 and PVS4120

External Signal Cable CAT-5	
BLUE/WHITE	FULL/FAULT
BLUE	EXTERNAL START
GREEN	EXTERNAL STOP / OVERFLOW
ORANGE/WHITE	+4-20mA
GREEN/WHITE	-4-20mA / COMMON
ORANGE	+12VDC
BROWN	COUNT / PULSE IN
BROWN/WHITE	STATUS

IMPORTANT

Wiring to remote/external functions should AVOID ALL AC POWER LINES if possible and/or be run in shielded cable terminating the shield at the AC ground terminal at the remote site.

2.6 Installation Checklist

Check the following items prior to use of sampler:

- 1) Sampler is mounted securely and level.
- 2) Intake Hose:
 - Free of kinks.
 - Properly installed into liquid.
 - Properly connected to volume control tube on metering chamber.
- 3) Discharge hose:
 - Free of kinks.
 - Natural downward slope to sample container.
 - Properly connected to (or in) sample container.
- 4) Power requirements:
 - Check battery electrical condition.
 - Recharge if necessary.

Section 3. Operation

3.1 Operating Sequence

3.1.1 Sampling Sequence

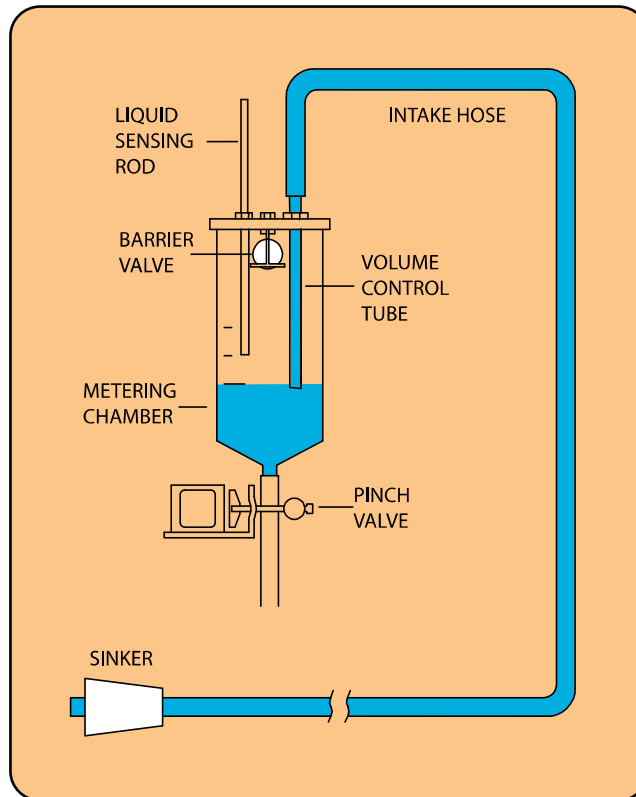

SAMPLING PROCESS:

1. High pressure air purge of intake hose.
2. Liquid is drawn into the metering chamber, up to the liquid sensing rod.
3. All excess liquid is purged from the system down to the level set by the volume control tube.
4. The sample is then released into either one composite container or one of several discrete containers.

The sampling sequence begins with a high pressure air **purge** of the intake assembly to remove residual liquid and obstructions. Upon completion of the pre-purge cycle, the system converts to a **vacuum** state, drawing the sample through the intake hose into the metering chamber. The system then **pressurizes**, ejecting excess fluid back through the intake line until the predetermined sample volume is achieved. The sample is then deposited under pressure into the sample container while the **post purge** again clears the intake line of any residual liquid.

Should the sampler, for any reason, not be able to draw a sufficient volume of fluid to obtain a sample, the unit automatically initiates a second attempt. Should a sample still not be delivered, the sequence will be abandoned and the unit will await the next initiation. Upon two consecutive failures, the sampler will suspend the sampling program until manually **RESTARTed**.

If programmed with the **FAULT SHUTDOWN** “disabled”, the sampler will not make a second attempt to draw the sample, but will simply abandon it and await the next sample initiation. Neither will the unit suspend the sampling program after consecutive failures. This function is provided for use in the event that the sample source may be lacking sufficient fluid from which to draw, for a period of time, yet allows the sampler to continue operating without a “FAULT SHUTDOWN” occurring. *The second attempt is not made to prevent unnecessary wear on the sampler.*

3.1.2 Line Voltage Failure

Should the sampler have a factory installed internal battery or have an external battery connected, the sampler will continue operating. The duration of operation will depend on the capability and charge level of either battery. The frequency and the length of each sample cycle will also have an impact on how long the batteries will last.

3.2 Operating Instructions

3.2.1 Sample Volume Adjustment

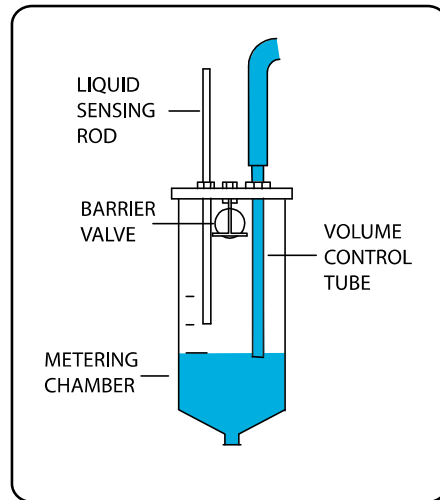

Setting the desired sample volume is accomplished by adjusting the height of the volume control tube within the metering chamber. The tube is mounted through the top of the chamber with a gland nut fixing the position. To adjust the sample volume, loosen the nut until the volume control tube may be moved freely. Raise or lower the bottom end of the tube to the desired volume using the lines provided on the side of the chamber as a *guide* (lines are spaced at 100 cc intervals with the exception of one at 50 cc). Tighten the gland nut to hold the volume control tube at the desired position.

IMPORTANT

The volume control tube should always be located below the liquid sensing rod.

NOTE

Hold the bottom nut while loosening / tightening the top nut, or it may become loosened from the metering chamber cover and create an imperceptible leak in the vacuum system.

3.2.2 Liquid Sensing Rod

This probe, also called the “level control rod”, is used to stop the sample intake. Always ensure that its lower end is located *above* the volume control tube. Approximately 1” difference is sufficient. If the fluid intake is turbulent within the metering chamber, more than 1” may be required to ensure splashing of fluid does not trigger probe.

In applications with substantial oil or grease, the rods can become coated and lose their conductivity. This is prevented by cleaning the rods regularly. In extreme cases, extra SS wire can be wrapped around the liquid sensing rod to increase its surface area.

IMPERATIVE: THE LIQUID SENSING ROD AND VOLUME CONTROL TUBES MUST BE KEPT CLEAN TO ENSURE CONDUCTIVITY NECESSARY TO DETECT THE PRESENCE OF THE FLUID.

Most PVS Samplers incorporate a **Barrier Valve** in the metering chamber cover, where the tubing from the pump enters. It consists of a cage containing a ball that will float if the sample should rise to the top of the chamber without detection. Should rod conductivity fail, the fluid brings the float into contact with an O-ring surrounding the pressure / vacuum port, sealing the entry to the tubing and the pump (where the fluid may cause serious damage). This O-ring **Barrier Valve** should be inspected regularly and replaced as necessary.

Due to the restriction of **Wetted Materials** (i.e. stainless steel, glass and fluorocarbons etc.), some models of the sampler do not contain this barrier valve. In these units, a secondary liquid-sensing circuit may be added as a precaution. This circuit is connected to the pump tubing fitting on the Metering Chamber cover.

3.3 Battery

3.3.1 Battery: Operating and Backup (optional)

CHARGING AND REVERSE POLARITY PROTECTION

The sampler will charge **ONLY** the factory installed internal battery. This charging takes place continually as long as there is incoming line power. Should the need arise to only charge the internal battery, as would be required to store the sampler for an extended period of time, simply place the “**RUN / OFF**” toggle switch in the **OFF** position, and leave the sampler power breaker on. Twenty-four (24) hours should be sufficient to fully charge the battery.

The sampler is equipped with **REVERSE POLARITY PROTECTION** for checking the connection of an external battery. When attaching an external battery, be sure to check the reverse polarity indicator. If it is **ON**, reverse the connections at the battery.

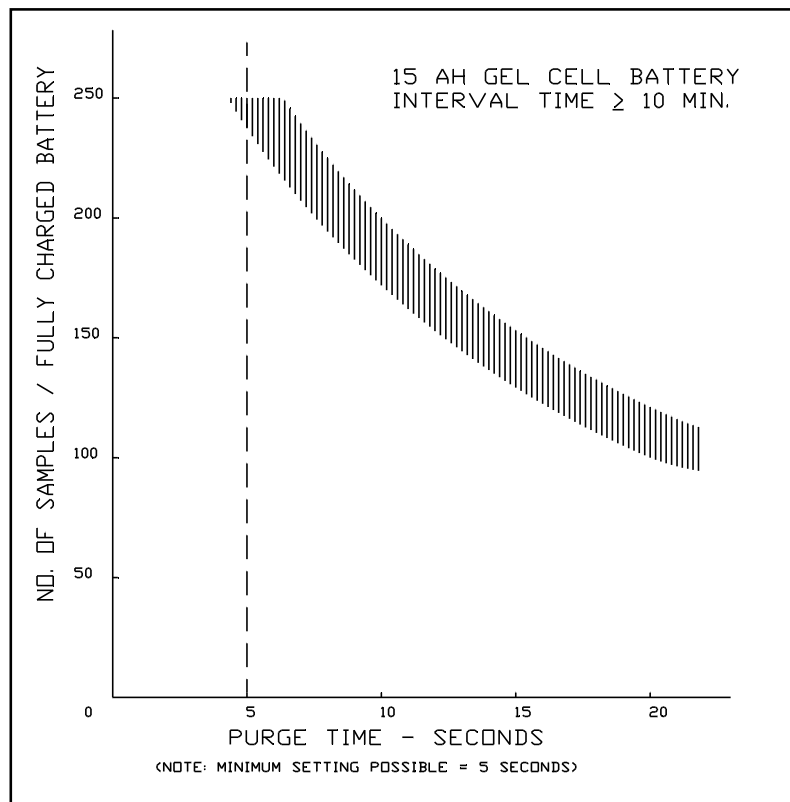

FIGURE 3-1. Battery Performance Curve

3.3.2 Battery: Microprocessor

SAMPLER CONTROLLER BACKUP BATTERY

The controller contains a 1/2AA, 3.6V lithium backup battery to maintain user settings during loss of system power. If power is removed for any reason, the controller will start a planned shutdown procedure which will save all user settings while its operating voltage is reduced from 5V to approximately 3.3V. The rate at which this voltage drops is slowed by the presence of a supercapacitor. By the time the voltage has reached 3.3V, the controller has safely stored all user settings and entered a “sleep” mode. This is an extremely low-power mode which is maintained by a trickle of current from the lithium battery, and can be maintained for many years under normal circumstances.

The battery is located on the top left hand side of the controller. It is accessible by the removal of the clear cover, and *should be changed under powered conditions*. Since the controller is a low-power device, this uncovering can be safely done, taking care that no conductive implement contacts sensitive circuit components.

If the controller starts to exhibit certain operating anomalies such as loss of user settings after sustained power outages or an inability to “wake up” after a normal shutdown, it may be due to a low or totally discharged backup battery. To predict the probability of these events, *regular examination of the battery condition is encouraged*. The battery status is easily determined while the controller is active. The process will not affect a running program. Battery status can be checked by use of the following touchpad sequence:

VIEW, OTHER OPTIONS,
select **MAINTENANCE, ENTER**, then select **B/U BATTERY TEST, ENTER**

The display will then show “PASSED”, “LOW” or “FAULT”. The latter two require battery replacement.

TO REPLACE BATTERY

1. Make sure the controller is powered.
2. Remove touchpad (clear) cover from the controller, remembering to handle internal ribbon cable and connector with care.
3. Locate the battery holder on the normal left side of the circuit board. The battery is a 1/2” cylinder about 1” in length. The positive (+) end of the battery has a raised button. Note the button’s relative position in the holder. It should be pointing away from the display side of the board.
4. Place new battery in holder, noting position of button with respect to the polarity indicators in the holder.
5. Check battery status, as above. If necessary, locate small white button at top of the control board (under display) and push to restore factory defaults.
6. Replace cover securely and re-enter user settings.

3.4 Test Procedure

1. Set volume control tube to 200 cc.
2. Set level probe 1" above bottom of volume control tube.
3. Turn on power. Place the "RUN/OFF" switch in the "RUN" position. After an initial delay of 15 to 20 seconds, the display will show a two line message, the top line displaying **SAMPLER HALTED** and an alternating message on the second line displaying why the sampling procedure was interrupted as well as the event time and date.
4. Enter the following sampling program:
 - a) Set purge time to 10 seconds. See **OTHER OPTIONS**
 - b) Set interval time to 2 minutes. See **SAMPLE INITIATION**
 - c) Set program type to composite. See **PROGRAM TYPE**
 - d) Set to terminate after 2 samples.
 - e) Press **RESTART, RESTART** (to confirm)
5. View the following displays:
 - a) Samples taken - should read 0
 - b) Remaining time - should be counting down from 2 minutes.
6. Sampling should begin when remaining time indicator reaches 0.
7. Upon completion of sample, view the following displays:
 - a) Samples taken - should read 1.
 - b) Remaining time - should be counting down from 5 minutes.
8. Press **MANUAL PURGE**. Press again to confirm.
9. Press **MANUAL ADVANCE**. Press again to confirm.
10. Press **MANUAL SAMPLE**. Press again to confirm.
11. If equipped with sample container full option, short circuit level probes in container (no dangerous voltage present - 16 Vdc). The message "SAMPLER HALTED External Stop" should appear on the display, the bottom line flashing.
12. Press **RESTART, RESTART**, the message "RESTART <Completed>" should appear on the display.

3.5 Troubleshooting

SAMPLER INOPERATIVE: Check supply voltage.

POWER ON BUT PUMP WILL NOT START: Check wiring from sampler controller to pump. Ensure controller is properly connected into harness.

- a) Pump defective.
- b) Sampler controller defective.

SAMPLER WILL NOT TAKE TIMED SAMPLE:

- a) Sampler controller defective.

SAMPLER WILL NOT INITIATE FROM AN EXTERNAL CONTACT: Check wiring from terminal strip to sampler controller plug. (Terminals 12 & 13)

- a) Sampler controller is defective.
- b) Sampler controller not *programmed* for **External Contact** input.

PUMP IS OPERATING, NO AIR PURGE OF INTAKE LINE: Check for blockage of intake hose by removing hose from the metering chamber volume control tube. Initiate manual sample and check for pressure/vacuum throughout sample cycle.

- a) If pressure/vacuum is present throughout sample cycle, intake hose is plugged.
- b) Pinch valve may not be closing the discharge hose with sufficient force to ensure an adequate seal. Increase tension by tightening the lock nuts on the pinch valve tension springs and/or replace discharge hose.
- c) Check for disconnected air lines from pump to metering chamber.
- d) Check for loose gland nuts.
- e) Pump flapper valves defective.

PURGE CYCLE OPERATIVE, NO SUCTION: Pinch valve may not be closing the discharge hose with sufficient force to ensure an adequate seal. Increase tension by tightening the lock nuts on the pinch valve tension springs and/or replace discharge hose.

- a) Check air lines, metering chamber O-rings and fittings for leakage.
- b) Solenoid valve clogged or not working.
- c) Intake tube, not below water level.

SAMPLER HAS HAD AN “EXTERNAL STOP”: Contact not supplied via terminal block.

- a) Sample container **Full** Level Probe has been triggered.

LEVEL SENSING PROBE INOPERATIVE: Check wire contact connections on volume control tube and level sensing probe. Check wiring to the sampler controller plug.

- a) Sampler controller defective
- b) Coating on probe and/or Volume Control Tube.

Section 4. Maintenance

The following maintenance procedure should be performed at regular intervals:

4.1 General Maintenance

1. Disconnect power.
2. Open metering chamber by removing wing nuts and chamber cover.
3. Clean volume control tube and level sensing probe with mild detergent. Alternatively, exchange tube and probe with clean set. Do not use any cleaner which may be harmful to the metering chamber cover. Do not use solvents such as acetone, benzene, carbon tetrachloride or lacquer thinners. Grease and oil may be removed with kerosene or aliphatic naphtha (non-aromatic).
4. Check and clean O-rings in metering chamber cover. Replace if damaged, worn or brittle.
5. Clean metering chamber using mild detergent. Do not use any cleaner which may be harmful to the clear acrylic, (e.g. petrochemical solvents, as noted above.) Do not use abrasives or “scouring” compounds.
6. Check discharge tubing for wear and replace as necessary.
7. Check pinch valve to ensure free movement.
8. If possible, run sampler through several sampling sequences in clean water.

4.2 Testing System Vacuum

Using the (optional) built-in pressure / vacuum gauge, take a reading to ensure system has no leaks. Optimal pressure is above 28 psi. Optimal vacuum should be 12 psi or better.

If the system is not performing at its peak, try the following:

1. Check intake hose for leaks/kinks.
2. Check discharge tube, ensure it has no leaks and is in good shape.
3. Check all fittings to ensure they are tight.
4. Make sure when tightening and loosening the gland nuts on the top of the metering chamber that the bottom nut is held secure and does not move on the cover. Ensure the top nut is securely tightened, and use a wrench if necessary.

5. If still system is still not performing at its peak, inspect pump and all pump tubing.

Section 5. Programming

5.1 General Programming

5.1.1 Guidelines

Controller settings may be changed at any time. Changes are termed **NEW ENTRIES**. No **NEW ENTRIES** will be acted upon unless the controller is **RESTARTed**. Once **RESTARTed**, all **NEW ENTRIES** become **ACTIVE SETTINGS**.

Every time the controller is **RESTARTed**, all accumulators (i.e. **SAMPLES TAKEN, TIME REMAINING, REMAINING PULSES**, etc.) are cleared and the **ACTIVE SETTINGS** are reloaded unless **NEW ENTRIES** have been made.

Remember - Start Delay is reloaded too !!

5.1.1.1 Flashing Text

Flashing text is the system wide prompt that indicates an input is required from the user. Flashing words or dual flashing digits prompt for arrow keys to be pressed to scroll through available options. A single flashing digit prompts for a numeric key to be pressed. When the desired option or number is shown on the display, press the **ENTER** key.

5.1.1.2 Real Time Clock

The controller has two basic timing modes. The simplest of these requires no maintenance; it simply provides a “heartbeat” for various timed functions. The other timing mode is the **REAL TIME CLOCK** that is used in several functions and must be correctly set. **This is likely the first item requiring programming.** *Although time may have been set at the factory, time zone shifts may require adjustment of the **Real Time Clock**.*

5.1.1.3 Total Bottles

Since the number of bottles is usually determined by customer requirement at the time of purchase, this variable will normally be set at the factory to match the actual container hardware. Choices are restricted to a single container (as in composite) or 2, 3, 4, 6, 8, 12 or 24. These all form instructions to the stepper motor in how it will behave when the internal command is given to step to the next container (as each step increment is 15°).

5.1.2 Touchpad Keys

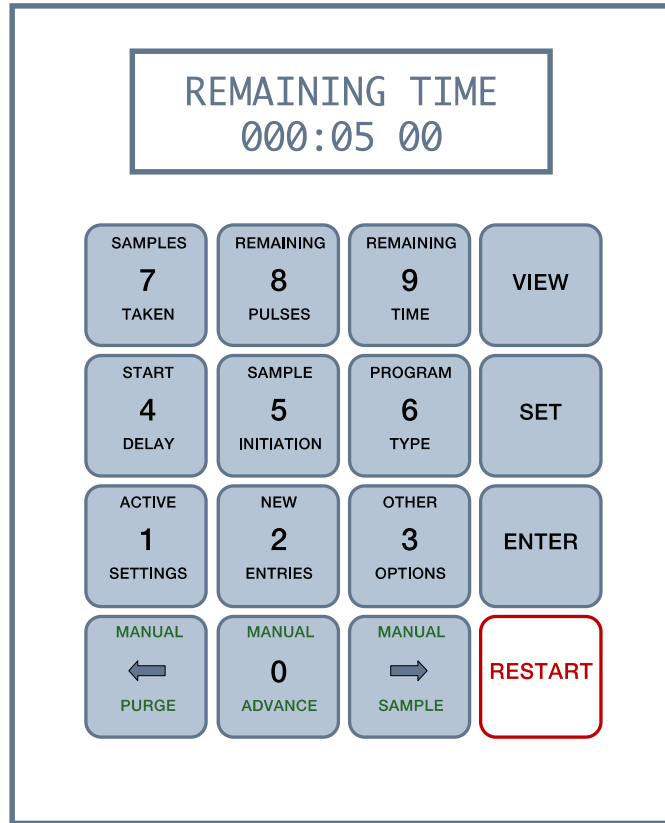

TABLE 5-1. Touchpad Button Descriptions



Button	Description
	The VIEW key is used to review alterable parameters currently in use. It has no effect on the program being executed at the time. Once pressed, the user is prompted for a FUNCTION to be viewed. The parameters visible under the function can be stepped through using the ENTER key.
	The SET key is used to change program settings or the entire sampling program. Changes made have no effect on the program being executed at the time until the RESTART key is pressed twice. To leave a programming sequence before entering it in memory either press SET or VIEW and the sequence is aborted.
	The ENTER key is used to complete either a VIEW or SET sequence, where sub-menu items are available. Under the control of the VIEW key, parameters are scrolled onto the display, changing with each use of the ENTER key until a complete display of the parameter is completed. Under the control of the SET key, parameters can be displayed, with the added ability to change their values, using the ENTER key to accept the new value until the entire parameter is displayed. (Note: New values are not operational at this time.)

TABLE 5-1. Touchpad Button Descriptions











Button	Description
	The RESTART key is used to load any new parameters into the operating program. Pressing it twice will initialize the program and terminate any existing sample program. Any parameters altered under the SET command are updated to the active program. If no parameters have been changed, the program is reset to its first instruction and the same sampler program is started again. This key requires a confirming second activation to complete its function. WARNING: Any program in progress is ended and all data is lost.
	SAMPLES TAKEN [VIEW]. The total number of samples taken can be shown on the display.
	REMAINING PULSES [VIEW]. In modes using internal or external pulse counting, the current status of the pulse count can be displayed.
	REMAINING TIME [VIEW]. Various views are available dependent on the method used to gather samples. Program variables will determine whether the displayed time is REMAINING TIME, ELAPSED TIME or START DELAY.
	START DELAY [VIEW/SET]. The start of a sample program can be made to occur at a fixed time or event. Options: DISABLE, TIME/DAY, PULSE INPUT, 4-20mA INPUT, EXTERNAL CONTACT, LEVEL CONTROL.
	SAMPLE INITIATION [VIEW/SET]. A sample program may be initiated and controlled by various internal and external parameters. These parameters determine how the program will begin its actions and how the results will be recorded. Options: DISABLE, INTERVAL TIME, PULSE INPUT, 4-20mA INPUT, EXTERNAL CONTACT.
	PROGRAM TYPE [VIEW/SET]. A sample program can be made to collect samples in a fixed style so that the results are useable in different ways. The type of program used may be hardware dependent. This will determine the sampler's ability to collect and store the desired samples. Options: COMPOSITE, DAILY CYCLE, CONSECUTIVE, MULTI-COMPOSITE, TIMED STEP.
	ACTIVE SETTINGS [VIEW]. Current sample program parameters can be reviewed by scrolling through them using the ENTER key as a toggle.
	NEW ENTRIES [SET]. Program all major program settings at once (including START DELAY, SAMPLE INITIATION, PROGRAM TYPE, and PURGE TIME). [VIEW]. Review parameters that have been changed since the sample program was started (only if the changes have been properly ENTERED). Scroll through them using the ENTER key as a toggle.
	OTHER OPTIONS [VIEW/SET]. Various options relating to equipment and information retrieval are available under this key. Changes in equipment setup can be entered here, and certain status information is also available here. Options: CLOCK, PURGE TIME, PINCH VALVE, FAULT SHUTDOWN, SAMPLER STATUS, CYCLES ABANDONED, BOTTLE POSITION, MAINTENANCE.

TABLE 5-1. Touchpad Button Descriptions

Button	Description
	<p>MANUAL PURGE. Purges the intake line independent of program control, as long as a programmed cycle has not started. Sampler starts its pump, creating pressure in the sample intake tube to purge it of any excess material that may be present. Button must be pressed twice to purge line. Sustained pressure on the key during the second press will cause purging to continue until the key is released.</p>
	<p>MANUAL ADVANCE. Distributor arm advances one position (e.g. to next bottle), dependent on the equipment available (discrete samplers only). This action is NOT updated to any current sampler program. Button must be pressed twice to initiate manual advance.</p>
	<p>MANUAL SAMPLE. Initiate a single Sample Cycle. Sampler must not be engaged in a sampling event at the time. This action and any resulting sample collected are NOT updated to any current sampler program. The Bottle Position is NOT advanced. Program will continue uninterrupted. Button must be pressed twice to initiate manual sample. Whether successful or not, the display will read "MANUAL SAMPLE Completed".</p>

5.1.3 General Terms

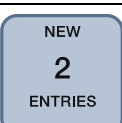
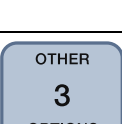
Many of the functions available on the Touchpad have a variety of options to enhance their capabilities. These options are programmable from the Touchpad and require only that the sampler have the correct equipment configuration to utilize them.

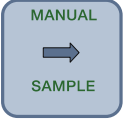
DISABLE

The display showing **disabled** will reflect the status of any function not being used.

TIME/DAY

The basis for several timed functions is the Real Time Operating System. Time (of) Day will be a means of setting the timing period for the **START DELAY** function. The format is on a weekly basis, requiring hour, minute, AM/PM and day inputs (HH:MM AM SUN). This means the Start Delay can be set to any particular minute in a week.

INTERVAL TIME

Sampler operation can be controlled by fixed time intervals which do not require Time/Day setting. **SAMPLE INITIATION** has an option whereby an interval time can be set between sample cycles. The controller will cause samples to be taken on a timed interval basis, continuing until the sample program is completed by a full jar or operator intercession.

PULSE INPUT

This option will allow the controller to determine the sampler operation based on external criteria. Pulses fed to an internal accumulator in the controller will be compared to the setting entered by the operator and will cause a sample cycle to start. The accumulator will reset immediately and counting of pulses

will begin again. There is no loss of count the sample cycle. Pulse requirements of the system are detailed in the specifications.

4-20mA INPUT

Where external devices do not themselves generate pulses in any relation to their process but generate a current signal of 4-20 mA, this input option will generate internal pulses proportional to the incoming 4-20 mA signal. These can then be treated the same as the **Pulse Input** option and accumulated in the controller to determine when a sample cycle will occur.

EXTERNAL CONTACT

The sampler controller can react to an external dry contact, otherwise known as a zero-voltage contact, to activate a sample cycle on demand. This will generally be when external conditions have caused a relay to close, requiring a sample be taken at that time.

LEVEL CONTROL

The **START DELAY** function is a special case of the **external contact** option, where the contact signal is required to be present for a pre-programmed time. This enables verification of the signal where fluctuations may occur in the level which would trigger samples at unwanted times. *This is the only case in which the START DELAY is not a single timed event.* The operation of the sampler after the level signal is verified will be controlled by whatever function is set in the **SAMPLE INITIATION**. It will continue until the level drops or the function is terminated by the controller. If the level drops before the function is finished, any sample cycle already in progress will be completed and then the system will shut down until the next verified level control signal.

COMPOSITE

A program option which determines that all the samples that are gathered will be placed in a single container. The sample program terminates after a specific number of samples.

MULTI-COMPOSITE

This option is used for discrete sampling applications, to deposit multiple samples to one container before advancing the distributor mechanism to the next container. The interval between each sample is controlled by the **SAMPLE INITIATION** options. The multi-composite setting is programmable up to 99 samples per container, for up to 24 containers depending on the hardware configuration.

CONSECUTIVE

This option is used for discrete sampling applications, to successively deposit one sample to each of a programmed number of containers on any given sample initiation. The consecutive setting is programmable up to 99 containers per sample initiation, although this may be severely limited by hardware configuration.

DAILY CYCLE

Allows the sampler to deposit equal sample volumes into a predetermined number of containers per programmed day. Each day may have any number of samples taken, dependent on the **SAMPLE INITIATION** mode chosen. Deposits are made to as many as 9 containers per day, to a cumulative total of 24 containers. (e.g. Choosing a 24 bottle format, the sampler may be programmed to deposit to **Three** (3) bottles on any six days of the week, together with up to **Six** (6) bottles on the seventh). Timing is dependent on the crystal-controlled Real Time Clock in the controller. The first program day will be the current day the programming is done, unless the **START DELAY** option is chosen to determine when sampling will begin.







TIMED STEP (Override)



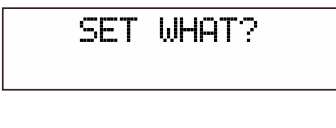

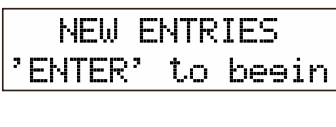
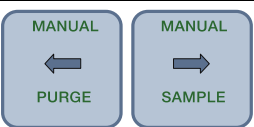

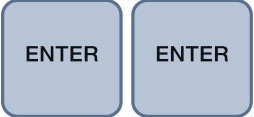

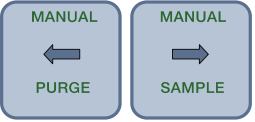

This option will cause the sample distributor to step to a new container *regardless* of the status of the **SAMPLE INITIATION** setting. For example, the actual sampling may be under the control of a flowmeter and taking samples based on the flow rate as determined by pulses or 4-20mA input to the controller. When the user-programmed **Timed** interval has elapsed, the controller will **Step** to a new container. The **Timed Step** can be set for any interval up to 99 hours 59 minutes. Progress of the step timer can be viewed by selecting **View, Program Type** and pressing **ENTER** twice. Thus you may view the **REMAINING TIME** or the step timing.

5.2 Quick Start Guide to Programming

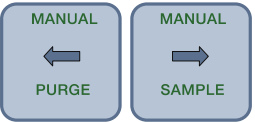
5.2.1 Automatic Sampling Program

To begin a new, quick program:

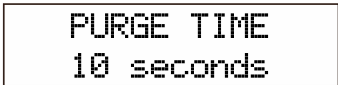
	Press "SET"	
	Press "NEW ENTRIES" . Press "ENTER"	
	START DELAY (how you will be delaying the sample program until certain external conditions are met). Select, using arrows, which parameter you would like, and adjust settings (see 5.3 Programming Start Delay). Options: DISABLE; TIME/DAY; PULSE INPUT; 4-20mA INPUT; EXTERNAL CONTACT; LEVEL CONTROL.	
	Press "ENTER" twice	

	<p>SAMPLE INITIATION (parameters for frequency of samples). Select, using arrows, which parameter you would like, and adjust settings (see 5.4 Programming Sample Initiation). Options: DISABLE; INTERVAL TIME; PULSE INPUT; 4-20mA INPUT; EXTERNAL CONTACT.</p>	
	<p>Press "ENTER" twice.</p>	
	<p>PROGRAM TYPE (which type of sampling program). Select, using arrows, which parameter you would like, and adjust settings (see 5.5 Programming Program Type). Options: COMPOSITE; MULTI-COMPOSITE; CONSECUTIVE; DAILY CYCLE; TIMED STEP (override).</p>	
	<p>Press "ENTER" twice.</p>	
	<p>PURGE TIME (set how long sampler will purge between samples, minimum of 10 seconds). Using # keys, enter the purge time needed for application (e.g. 100 ft draw at 5 ft/sec = 20 sec). Press "ENTER".</p>	
	<p>Press "RESTART" twice.</p>	

Sampling is ready to go.

5.2.2 Taking a Manual Sample

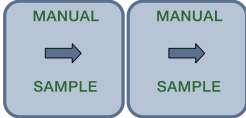

To take a sample manually, simply press the "Manual Sample" button twice. Manual samples will not interrupt the current automatic sampling program.

5.2.3 Viewing Program Parameters



To view the program or remaining time, press the "VIEW" button, followed by the button representing what you want to see, e.g. "REMAINING TIME".

5.2.4 Setting Program Parameters Individually

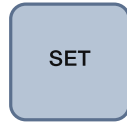

To modify any of the settings individually press the “SET” button followed by the appropriate button based on what parameter is being changed.

5.3 Programming START DELAY



5.3.1 START DELAY Overview

START DELAY is the function which will delay the beginning of a sample program until certain external conditions are met. Upon meeting those conditions, the sampler will initiate a sample cycle and then operate based on the **SAMPLE INITIATION** parameters. Under **START DELAY**, flashing text prompts the user to scroll through available options by pressing arrow keys. These options only require that the correct equipment is present to utilize them. The last option selected in previous programming will be the first to appear on the display.

<p>START DELAY Disabled</p>	<p>The display showing disabled will reflect the fact that the function is not being used.</p>
<p>START DELAY Time/Day</p>	<p>The basis for several timed functions is the Real Time Operating System. Time (of) Day will be a means of setting the timing period for the START DELAY function. The format is on a weekly basis, requiring hour, minute, AM/PM and day inputs (HH:MM AM SUN). This means the <i>start</i> of a sampler program can be delayed up to seven days.</p>
<p>START DELAY Pulse Input</p>	<p>This option will allow the controller to determine the sampler’s start of operation based on external pulses. Pulses fed to an internal accumulator in the controller will be compared to the setting entered by the operator. Pulse requirements of the system are detailed in the specifications.</p>
<p>START DELAY 4-20mA Input</p>	<p>Where external devices do not themselves generate pulses in any relation to their process but generate a current signal of 4-20mA, this input option will generate internal pulses proportional to the incoming 4-20mA signal. These can then be treated the same as the Pulse Input option and accumulated in the controller to determine when a sample program should start.</p>

<p>START DELAY External Contact</p>	<p>The sampler controller can react to an external dry contact, otherwise known as a zero-voltage contact, to activate a sample program on demand. This will generally be when external conditions have caused a relay to close, requiring a sample program be started at that time.</p>
<p>START DELAY Level Control</p>	<p>This option is a special case of the external contact option. The key difference is that the contact closure must be present for a pre-programmed time, thus enabling verification of the signal. This will accommodate fluctuations as seen in a level switch, thereby avoiding triggering of samples at unwanted times. <i>This is the only case in which the START DELAY is not a single timed event.</i> Should the contact open for the same pre-programmed time, the sampler will (after completing any sample cycle already in progress), halt the sampling initiation and await the next verified signal. At this time, the sampling program will resume.</p>

5.3.2 START DELAY using Time/Day

START DELAY
Time/Day

The following sequence of entries are made on the Touchpad to create a future starting time for the operation of the Sampler. The ACTIVE SETTINGS are not being altered.



1. Press the **SET** key.



2. Press the **START DELAY** key.



3. Press an **ARROW** key. Continue until **Time/Day** is shown on the display.



4. Press the **ENTER** key.

TIME/DAY
02:00 PM SAT

When setting the time, a single flashing digit indicates an input from a numeric key is required. Press a number key to enter a value. The next digits flash in succession. Enter each as required. The format is HH:MM.

When the four digits are entered, press **ENTER**. Any wrong entries will require re-entry. There are two methods of correcting a mistake. The digit flashing “wraps around” and begins again, at which time the correct entry may be pressed. Alternately, the arrow keys can be used to reposition the flashing prompt over the error, which can then be replaced with the correct value.

ENTER

The flashing prompt advances to the AM/PM indicator. Press the **ARROW** key until the right indicator is shown. Press **ENTER**.

The flashing prompt advances to the day indicator. Press the **ARROW** key repeatedly until the correct day appears. Press **ENTER**.

START DELAY
<ENTERED>

The display will echo the last entry with <ENTERED>.

RESTART RESTART

The controller has now been given a new value for **START DELAY**. The new values reside in the NEW ENTRIES area of the controller memory. To make these changes active, press the **RESTART** key, then again press it to confirm your choice. The controller will then wait until the designated time before starting its sampling program.

Summary of Sequence:
SET, START DELAY, ARROW(S), ENTER, #, #, #, #, ENTER, ARROW(S), ENTER, ARROW(S), ENTER, RESTART, RESTART.

5.3.3 START DELAY using Pulse Input

```
START DELAY  
Pulse Input
```

The following sequence of entries are made on the Touchpad to create a future starting time for the operation of the Sampler. The ACTIVE SETTINGS are not being altered.



1. Press the **SET** key.



2. Press the **START DELAY** key.



3. Press an **ARROW** key. Continue until **Pulse Input** is shown on the display.



4. Press the **ENTER** key.

```
PULSE INPUT  
0000001
```

The display will show a new screen containing the option title **PULSE INPUT** on the top line and a 7 digit number with the leftmost digit flashing as an input prompt. To set the number of pulses required to be input before a sample program is started, use the **ARROW** keys to move the flashing prompt until it is over the digit requiring change.



Press a number key (0-9) to replace any existing number and advance the flashing prompt to the next digit to change. Replace digits as required, then press **ENTER**.

```
START DELAY  
<ENTERED>
```

The display will echo the last entry with **<ENTERED>**.

Any wrong entries will require re-entry. If **ENTER** has not been pressed, reposition the prompt over the incorrect digit and replace it. After **ENTER** has been pressed, the entire entry must be redone from the beginning (press **SET**).



The controller has now been given a new value for **START DELAY**. The new values reside in the NEW ENTRIES area of the controller memory. To make these changes active, press the **RESTART** key, then again press it to confirm your choice. The controller will then wait until the required pulses have been received before starting its sampling program.

Summary of Sequence:
SET, START DELAY, ARROW(S), ENTER, #####, ENTER, RESTART, RESTART.

5.3.4 START DELAY using 4-20mA Input

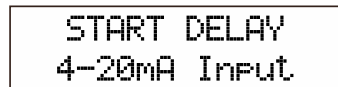

The following sequence of entries are made on the Touchpad to create a future starting time for the operation of the Sampler. The ACTIVE SETTINGS are not being altered.



1. Press the **SET** key.



2. Press the **START DELAY** key.



3. Press an **ARROW** key. Continue until **4-20mA Input** is shown on the display.



4. Press the **ENTER** key.

4-20mA INPUT
0000010

The display will show a new screen containing the option title **4-20mA INPUT** on the top line and a 7 digit number with the leftmost digit flashing as a prompt for input. The 4-20 mA input will be converted by the controller to pulses, proportional to the span of the input, at the rate set in the specifications. To set the number of pulses required to be input before a sample program is started, use the **ARROW** keys to move the flashing prompt until it is over the digit requiring change.

ENTER

Press a number key (0-9) to replace any existing number and advance the flashing prompt to the next digit to change. Replace digits as required, then press **ENTER**.

START DELAY
<ENTERED>

The display will echo the last entry with <ENTERED>.

Any wrong entries will require re-entry. If **ENTER** has not been pressed, reposition the flashing prompt over the incorrect digit and replace it. After **ENTER** has been pressed, the entire entry must be redone from the beginning (press **SET**).

RESTART RESTART

The controller has now been given a new value for **START DELAY**. The new values reside in the **NEW ENTRIES** area of the controller memory. To make these changes active, press the **RESTART** key, then again press it to confirm your choice. The controller will then wait until the required pulses have been received before starting its sampling program.

Summary of Sequence:
SET, START DELAY, ARROW(S), ENTER, #####, ENTER, RESTART, RESTART.

5.3.5 START DELAY using External Contact

START DELAY
External Contact

The following sequence of entries are made on the Touchpad to create a future starting time for the operation of the Sampler. The ACTIVE SETTINGS are not being altered.



1. Press the **SET** key.



2. Press the **START DELAY** key.



3. Press an **ARROW** key. Continue until **External Contact** is shown on the display.



4. Press the **ENTER** key.

START DELAY
<ENTERED>

The display will echo the last entry with <ENTERED>.



The controller has now been given a new value for **START DELAY**. The new value resides in the NEW ENTRIES area of the controller memory. To make this change active, press the **RESTART** key, then again press it to confirm your choice. The controller will then wait until it receives a contact closure (at the **External Start** inputs on the terminal block) before starting its sampling program.

Summary of Sequence:
SET, START DELAY, ARROW(S), ENTER, RESTART, RESTART.

5.3.6 START DELAY using Level Control

START DELAY
Level Control

The following sequence of entries are made on the Touchpad to create a future starting time for the operation of the Sampler. The ACTIVE SETTINGS are not being altered.



1. Press the **SET** key.



2. Press the **START DELAY** key.



3. Press an **ARROW** key. Continue until **Level Control** is shown on the display.



4. Press the **ENTER** key.

Minimum Contact
Time: 03 seconds

The display will change to read "Minimum Contact Time: 01 seconds". The actual time shown may be any two digit number. The first digit will be flashing as a prompt for input.



Press a number key (0-9). The number will replace the current number and advance the flashing prompt to the next digit. Press a second number key (0-9). Repeat this procedure if number is wrong, until desired time is displayed. Press the **ENTER** key.

START DELAY
<ENTERED>

The display will echo the last entry with START DELAY, <ENTERED>.



The controller has now been given a new value for **START DELAY**. The new values reside in the NEW ENTRIES area of the controller memory. To make these changes active, press the **RESTART** key, then again press it to confirm your choice. The controller will then wait until it receives a contact closure (at the **External Start** inputs on the terminal block). The contact must remain closed for the length of time programmed in the steps above.

Summary of Sequence:
SET, START DELAY, ARROW(S), ENTER, ##, ENTER, RESTART, RESTART.

5.4 Programming SAMPLE INITIATION



5.4.1 SAMPLE INITIATION Overview

SAMPLE INITIATION is the function that will determine the frequency that samples are drawn. There is available on the Touchpad a variety of options to enhance the capabilities of this function. When the Sample Initiation has been chosen to be set, a list of options is presented as flashing text below the main heading of the function selected. The list is advanced using the **ARROW** keys (any direction) until the desired option is displayed. These options are programmable from the Touchpad and require only that the sampler have the correct equipment configuration to utilize them. The last option selected in previous programming will be the first to appear on the display.

<p>SAMPLE INITIAT'N Disabled</p>	<p>The display showing disabled will reflect the fact that the function is not being used.</p>
<p>SAMPLE INITIAT'N Interval Time</p>	<p>Sampler operation can be started at uniform intervals. This option allows an interval time to be set between sample cycles.</p>

<p>SAMPLE INITIAT'N Pulse Input</p>	<p>This option will allow the controller to determine the SAMPLE INITIATION based on external pulses. Pulses fed to an internal accumulator in the controller will be compared to the setting entered by the operator and will cause a sample cycle to start. The accumulator will reset immediately and counting of pulses will begin again. There is no loss of count during the sample cycle. Pulse requirements of the system are detailed in the specifications.</p>
<p>SAMPLE INITIAT'N 4-20mA Input</p>	<p>Where external devices do not themselves generate pulses in any relation to their process but generate a current signal of 4-20mA, this input option will generate internal pulses proportional to the incoming 4-20mA signal. These can then be treated the same as the Pulse Input option and accumulated in the controller to determine when a sample cycle should occur.</p>
<p>SAMPLE INITIAT'N External Contact</p>	<p>The sampler controller can react to an external dry contact, otherwise known as a zero-voltage contact, to activate a sample cycle on demand. This will generally be when external conditions have caused a relay to close, whose contact will cause a sample to be taken.</p>

5.4.2 SAMPLE INITIATION using Interval Time

SAMPLE INITIAT'N
Interval Time

The following sequence of entries are made on the Touchpad to form a basic operating parameter for operation of the sampler. This will determine the time from the start of a sample cycle to the start of the next sample cycle. No time is lost during the actual sample cycle. The ACTIVE SETTINGS are not being altered.



1. Press the **SET** key.



2. Press the **SAMPLE INITIATION** key.



3. Press an **ARROW** key. Continue until **Interval Time** is shown on the display.



4. Press the **ENTER** key.



When setting the time, a flashing digit prompts for input from a numeric key. To set the time, press a numeric key to enter a value and advance to each digit in succession. The format is HHH:MM. The minimum time can be set to 1 minute, however, practical considerations, such as equipment duty cycle, maintenance and service life suggest times of 3 minutes or longer.



When the five digits are entered, press **ENTER**. Any wrong entries will require re-entry. There are two methods of correcting a mistake. The digit flashing “wraps around” and begins again, at which time the correct entry may be pressed. Alternately, the arrow keys can be used to reposition the flashing prompt over the error, which can then be replaced with the correct value.



The display will echo the last entry with <ENTERED>.



The controller has now been given a new value for **SAMPLE INITIATION**. The new values reside in the NEW ENTRIES area of the controller memory. To make these changes active, press the **RESTART** key, then again press it to confirm your choice. The controller will then wait the designated time before taking a sample.

Summary of Sequence:
SET, SAMPLE INITIATION, ARROW(S), ENTER, ###:##, ENTER, RESTART, RESTART.

5.4.3 SAMPLE INITIATION using Pulse Input

SAMPLE INITIAT'N
Pulse Input

The following sequence of entries are made on the Touchpad to form a basic operating parameter for operation of the sampler. This will determine the number of pulses from the start of a sample cycle to the start of the next sample cycle. The ACTIVE SETTINGS are not being altered.

SET

1. Press the SET key.

SAMPLE
5
INITIATION

2. Press the SAMPLE INITIATION key.

MANUAL
→
SAMPLE

3. Press an ARROW key. Continue until Pulse Input is shown on the display.

ENTER

4. Press the ENTER key.

PULSE INPUT
0000001

The display will show a new screen containing the option title PULSE INPUT on the top line and a 7 digit number with the leftmost digit flashing to prompt for a numeric input. To set the number of pulses required to be input before a sample is taken, by use of the ARROW keys, move the flashing prompt until it is over the digit requiring change.

ENTER

Press a number key (0-9) to replace any existing number and advance the flashing prompt to the next digit to change. Replace digits as required, then press ENTER.

SAMPLE INITIAT'N
<ENTERED>

The display will echo the last entry with <ENTERED>.

Any wrong entries will require re-entry. If ENTER has not been pressed, reposition the prompt over the incorrect digit and replace it. After ENTER has been pressed, the entire entry must be redone from the beginning (press SET).



The controller has now been given a new value for **SAMPLE INITIATION**. The new values reside in the **NEW ENTRIES** area of the controller memory. To make these changes active, press the **RESTART** key, then again press it to confirm your choice. The controller will then wait until the required pulses have been received before taking a sample.

Summary of Sequence:
SET, SAMPLE INITIATION, ARROW(S), ENTER, #####, ENTER, RESTART, RESTART.

5.4.4 **SAMPLE INITIATION** using 4-20mA Input

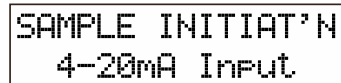

The following sequence of entries are made on the Touchpad to form a basic operating parameter for operation of the sampler. This will determine the number of pulses from the start of a sample cycle to the start of the next sample cycle. The **ACTIVE SETTINGS** are not being altered.



1. Press the **SET** key.



2. Press the **SAMPLE INITIATION** key.



3. Press an **ARROW** key. Continue until **4-20mA Input** is shown on the display.



4. Press the **ENTER** key.

```
4-20mA INPUT
0000010
```

The display will show a new screen containing the option title **4-20mA INPUT** on the top line and a 7 digit number with the leftmost digit flashing as a prompt for input. The 4-20 mA input will be converted by the controller to pulses, proportional to the span of the input, at the rate set in the specifications. To set the number of pulses required to be input before a sample is taken, use the **ARROW** keys to move the flashing prompt until it is over the digit requiring change.



Press a number key (0-9) to replace any existing number and advance the flashing prompt to the next digit to change. Replace digits as required, then press **ENTER**.

```
SAMPLE INITIAT'N
<ENTERED>
```

The display will echo the last entry with <ENTERED>.

Any wrong entries will require re entry. If **ENTER** has not been pressed, reposition the prompt over the incorrect digit and replace it. After **ENTER** has been pressed, the entire entry must be redone from the beginning (press SET).



The controller has now been given a new value for **SAMPLE INITIATION**. The new values reside in the NEW ENTRIES area of the controller memory. To make these changes active, press the **RESTART** key, then again press it to confirm your choice. The controller will then wait until the required pulses have been received before taking a sample.

Summary of Sequence:
SET, SAMPLE INITIATION, ARROW(S), ENTER, #####, ENTER, RESTART, RESTART.

5.4.5 SAMPLE INITIATION using External Contact

SAMPLE INITIAT'N
External Contact

The following sequence of entries are made on the Touchpad to form a basic operating parameter for operation of the sampler. This will determine the time between samples being taken. The ACTIVE SETTINGS are not being altered.



1. Press the **SET** key.



2. Press the **SAMPLE INITIATION** key.



3. Press an **ARROW** key. Continue until **External Contact** is shown on the display.



4. Press the **ENTER** key.

SAMPLE INITIAT'N
<ENTERED>

The display will echo the last entry with <ENTERED>.



The controller has now been given a new value for **SAMPLE INITIATION**. The new value resides in the NEW ENTRIES area of the controller memory. To make this change active, press the **RESTART** key, then again press it to confirm your choice. The controller will then wait until a contact closure has been received before taking a sample.

Summary of Sequence:
SET, SAMPLE INITIATION, ARROW(S), ENTER, RESTART, RESTART.

5.5 Programming PROGRAM TYPE



5.5.1 PROGRAM TYPE Overview

PROGRAM TYPE is the function which determines how the sampler will perform its program. A variety of options are available. These options are programmable from the Touchpad and require only that the sampler have the correct equipment configuration to utilize them. The basic function of the Program Type is to determine the movement of the distributor.

<p style="text-align: center;">PROGRAM TYPE Composite</p>	<p>The program option which determines that all the samples that are gathered will be placed in a single container. The sampler program terminates after the specified number of samples have been taken.</p>
<p style="text-align: center;">PROGRAM TYPE Multi-Composite</p>	<p>This option is used for discrete sampling applications, to deposit one or a number of samples to one container before advancing to the next container. The interval between samples is controlled by the SAMPLE INITIATION function. The multi-composite setting is programmable up to 99 samples per container, for up to 24 containers depending on the hardware configuration.</p>
<p style="text-align: center;">PROGRAM TYPE Consecutive</p>	<p>This option is used for discrete sampling applications, to successively deposit one sample to each of a programmed number of containers on any given sample initiation. The consecutive setting is programmable up to 99 containers per sample initiation.</p>
<p style="text-align: center;">PROGRAM TYPE Daily Cycle</p>	<p>Allows the sampler to deposit equal sample volumes into a predetermined number of containers per programmed day. Each day may have any number of samples taken, dependent on the SAMPLE INITIATION mode chosen. Deposits are made to as many as 9 containers per day, to a cumulative total of 24 containers. Timing is dependent on the crystal-controlled Real Time Clock in the controller. The first program day will be the current day the programming is done.</p>

<p>PROGRAM TYPE Timed Step</p>	<p>This option will cause the sampler to step to a new container <i>regardless</i> of the status of the SAMPLE INITIATION setting. For example, the actual sampling may be under the control of a flowmeter and taking samples based on the flow rate as determined by pulses or 4-20mA input to the controller. When the user-programmed timed interval has elapsed, the controller will step to a new container. The Timed Step can be set for any interval up to 99 hours 59 minutes. Progress of the step timer can be viewed by selecting View, Program Type and pressing ENTER twice. Thus you may view the step timing and the amount of time until the next step occurs.</p>
------------------------------------	---

5.5.2 PROGRAM TYPE - Composite

PROGRAM TYPE
Composite

The following sequence of entries are made on the Touchpad to describe how the Sampler controller is to store the samples it takes, in the hardware specified in its configuration. The ACTIVE SETTINGS are not being altered.



1. Press the **SET** key.



2. Press the **PROGRAM TYPE** key.



3. Press an **ARROW** key. Continue until **Composite** is shown on the display (for storage in single container).



4. Press the **ENTER** key.

Terminate After
0003000 Samples

The display will respond with the message “Terminate After 0000009 Samples”. The numerical value will be whatever value was last placed in the controller’s memory, usually after previous programming. To keep the previous value press **ENTER**, or, to set a new value, use the **ARROW** keys to advance the flashing prompt to the desired location and replace the digits under the prompt by using the digits (0-9) on the Touchpad. Each new entry will automatically advance the prompt to the next location. In this way, the entire 7 digit number can be changed. The **ARROW** keys can be used to skip already correct digits, in either direction.

ENTER

When the 9 digit number is correctly entered, press **ENTER**.

PROGRAM TYPE
<ENTERED>

The display will echo the last entry with PROGRAM TYPE <ENTERED>.

RESTART RESTART

The controller has now been given a new value for **PROGRAM TYPE**. The new value resides in the NEW ENTRIES area of the controller memory. To make these changes active, press the **RESTART** key, then again press it to confirm your choice. The controller will then be set to perform as a Composite Sampler in conjunction with the parameters programmed under the **START DELAY** and **SAMPLE INITIATION** variables.

Summary of Sequence:
SET, PROGRAM TYPE, ARROW(S), ENTER, #####, ENTER, RESTART, RESTART.

5.5.3 PROGRAM TYPE - Daily Cycle

```
PROGRAM TYPE
Daily Cycle
```

The following sequence of entries are made on the Touchpad to describe how the Sampler controller is to store the samples it takes, in the hardware specified in its configuration. The ACTIVE SETTINGS are not being altered.

SET

1. Press the **SET** key.

```
PROGRAM
 6
TYPE
```

2. Press the **PROGRAM TYPE** key.

```
MANUAL
 →
SAMPLE
```

3. Press an **ARROW** key. Continue until **Daily Cycle** is shown on the display (for storage in a single container or a multiple container array).

ENTER

4. Press the **ENTER** key.

```
DAILY CYCLE
Total Bottles 24
```

The display will respond with the message "DAILY CYCLE Total Bottles `nm`". The two digits will be flashing as a prompt that they can be changed using the arrow keys.

ENTER

Press **ENTER**. The second line of the display will change to show a day of the week. The first day that shows will be the day the programming is being done. Following the day of the week will be a flashing digit, which is prompting for a numeric input. Using the number keys (0-9) enter the number of bottles to be utilized on the displayed day, to a maximum of 9 or the total number of containers not yet allocated from the array.

```
DAILY CYCLE
Tue: 0 bottles
```

ENTER

Press **ENTER**. This will register the value for the displayed day and change that display to show the next day. Again, enter a number for that particular day, remembering that only containers not previously allocated

```
DAILY CYCLE
Wed: 0 bottles
```

can be chosen. If no change in the displayed value is required, the value has been changed or the value is zero, pressing ENTER will advance the day of the week. Therefore...

ENTER

Press **ENTER**. Repeat the above procedures until all the required containers, on their respective days, have been allocated, **or** the 7 days of the week are all selected. The total number available is never allowed to be more than the amount registered as the **two digit** representation of the hardware configuration in the “Total bottles 00” entry.

```
PROGRAM TYPE
<ENTERED>
```

The display will echo the last entry with **PROGRAM TYPE <ENTERED>**.

RESTART RESTART

The controller has now been given a new value for **PROGRAM TYPE**. The new value resides in the NEW ENTRIES area of the controller memory. To make these changes active, press the **RESTART** key, then again press it to confirm your choice. The controller will then be set to perform as a Daily Cycle Sampler in conjunction with the parameters programmed under the **START DELAY** and **SAMPLE INITIATION** variables.

Summary of Sequence:
SET, PROGRAM TYPE, ARROW(S), ENTER, ARROW(S), ENTER, #, ENTER, #, ENTER, #, ENTER, #, ENTER, #, ENTER, #, ENTER, #, ENTER, RESTART, RESTART.

5.5.4 PROGRAM TYPE - Daily Cycle for Dual Station

Dual Station – Flip Flop Application Only (*Single Controller, Two Metering Chambers*)

```
PROGRAM TYPE
Daily Cycle
```

The following sequence of entries are made on the Touchpad to describe how the Sampler controller is to store the samples it takes, when the hardware specified is configured to deliver Samples from two separate sources. The ACTIVE SETTINGS are not being altered.



1. Press the **SET** key.



2. Press the **PROGRAM TYPE** key.

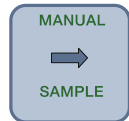

3. Press an **ARROW** key. Continue until **Daily Cycle** is shown on the display.



4. Press the **ENTER** key.

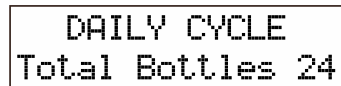

The display will show the response “DAILY CYCLE Total Bottles *nm*“. The two digits, *nm*, will flash, indicating they can be changed . In this application, the number of bottles **must** be set to **24**.



Press **ENTER**. The second line of the display will change to show a day of the week. The first day that shows will be the day the programming is being done.

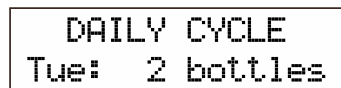

Following the day of the week will be a flashing single digit, which is the prompt for a numeric input. Using the number keys (0-9) enter the number of bottles to be utilized on the first day. In this application this will be set to 2.



Press **ENTER**. This will register the value for the displayed day and change that display to show the next day. Again, enter a number for that particular day, remembering that in this application this will be set to 2. If no change in the displayed value is required, the value has been changed or the value is zero, pressing ENTER will advance the day of the week. Therefore...

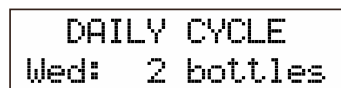

Press **ENTER**. Repeat the above procedures until all the required containers, on their respective days, have been allocated, **or** the 7 days of the week are all selected. If all 7 days have been selected, then continuous sampling will occur for up to 12 days.

PROGRAM TYPE
<ENTERED>

The display will echo the last entry with **PROGRAM TYPE <ENTERED>**.

RESTART RESTART

The controller has now been given a new value for **PROGRAM TYPE**. The new value resides in the NEW ENTRIES area of the controller memory. To make these changes active, press the **RESTART** key, then again press it to confirm your choice. The controller will then be set to perform as a *Dual Station Sampler* in conjunction with the parameters programmed under the **START DELAY** and **SAMPLE INITIATION** variables.

Summary of Sequence:
SET, PROGRAM TYPE, ARROW(S), ENTER, ARROW(S), ENTER, #, ENTER, #, ENTER, #, ENTER, #, ENTER, #, ENTER, #, ENTER, #, ENTER, #, ENTER, RESTART, RESTART.

5.5.5 PROGRAM TYPE - Consecutive

PROGRAM TYPE
Consecutive

The following sequence of entries are made on the Touchpad to describe how the Sampler controller is to store the samples it takes, in the hardware specified in its configuration. The ACTIVE SETTINGS are not being altered.

SET

1. Press the **SET** key.

PROGRAM
6
TYPE

2. Press the **PROGRAM TYPE** key.

MANUAL
→
SAMPLE

3. Press an **ARROW** key. Continue until **Consecutive** is shown on the display (for storage in single multiple container array).

ENTER

4. Press the **ENTER** key.

CONSECUTIVE
Total Bottles 24

The display will show the response “CONSECUTIVE Total Bottles *nn*“. The two digits, *nn*, will be flashing, indicating they can be changed by scrolling with the arrow keys.

ENTER

00 bottles Per
Sample Cycle

Press **ENTER**. The display now reads “*nn* bottles per Sample Cycle”. A previously set value will be displayed. One of the digits is flashing. Using the number keys (0-9), enter the first digit of the number of bottles that will be used at each sampling time determined by the programming setting, i.e., enter the number of samples to be taken at each predetermined time. After the first digit is entered, the second digit will flash prompting for the remaining digit of the entry. The sampler will repeat this quantity each time the sampling is initiated, until the “Total-Bottles” setting is reached.

ENTER

PROGRAM TYPE
<ENTERED>

Press **ENTER**. The display now shows “PROGRAM TYPE <ENTERED>”.

RESTART RESTART

The controller has now been given a new value for **PROGRAM TYPE**. The new value resides in the NEW ENTRIES area of the controller memory. To make these changes active, press the **RESTART** key, then again press it to confirm your choice. The controller will then be set to perform as a Consecutive Sampler in conjunction with the parameters programmed under the **START DELAY** and **SAMPLE INITIATION** variables.

Summary of Sequence:
SET, PROGRAM TYPE, ARROW(S), ENTER, ENTER, ##, ENTER, RESTART, RESTART.

5.5.6 PROGRAM TYPE - Multi-Composite

```
PROGRAM TYPE
Multi-Composite
```

The following sequence of entries are made on the Touchpad to describe how the Sampler controller is to store the samples it takes, in the hardware specified in its configuration. The ACTIVE SETTINGS are not being altered.



1. Press the **SET** key.



2. Press the **PROGRAM TYPE** key.

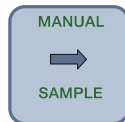

3. Press an **ARROW** key. Continue until **Multi-Composite** is shown on the display (for storage in multiple container array).



4. Press the **ENTER** key.

```
MULTI-COMPOSITE
Total bottles 24
```

The display will respond with the message “MULTI-COMPOSITE Total Bottles *nn*”. The two digits, *nn*, will be flashing, indicating they can be changed by scrolling with the arrow keys.



```
01 Cycle
Per bottle
```

Press **ENTER**. The display now reads “*nn* Cycles per bottle”. A previously set value is displayed. One of the digits is flashing, prompting for a numeric entry. Using the number keys (0-9), select the number of times the same bottle will be used at the times determined by the programming, i.e., enter the number of samples to be taken before the stepper advances to the next bottle. After the first digit is entered, the second digit will flash, prompting for the second digit of the entry. Each sample placed in a bottle will be a complete cycle. The program will repeat this action each time the sampling is initiated, until the “Total Bottles” setting is reached.



Press **ENTER**. The display now reads PROGRAM TYPE <ENTERED>.



The controller has now been given a new value for **PROGRAM TYPE**. The new value resides in the NEW ENTRIES area of the controller memory. To make these changes active, press the **RESTART** key, then again press it to confirm your choice. The controller will then be set to perform as a Multi-Composite Sampler in conjunction with the parameters programmed under the **START DELAY** and **SAMPLE INITIATION** variables.

Summary of Sequence:
SET, PROGRAM TYPE, ARROW(S), ENTER, ENTER, ##, ENTER, RESTART, RESTART.

5.5.7 PROGRAM TYPE - Timed Step



The following sequence of entries are made on the Touchpad to describe how the Sampler controller is to store the samples it takes, in the hardware specified in its configuration. The **ACTIVE SETTINGS** are not being altered.



1. Press the **SET** key.



2. Press the **PROGRAM TYPE** key.



3. Press an **ARROW** key. Continue until **Timed Step** is shown on the display (for storage in multiple container array).



4. Press the **ENTER** key.

```
TIMED STEP
Total bottles 24
```

Press **ENTER**. The display will show the response “TIMED STEP Total Bottles *nn*”. The two digits, *nn*, will be flashing, indicating they can be changed by scrolling with the arrow keys.



```
TIMED STEP
Step Intvl 00:00
```

Press **ENTER**. The bottom line of the display now reads “Step Intvl 00:00”. A previously set value is displayed. One of the digits is flashing, prompting for first digit of a numeric input. The format is HH:MM. Using the number keys (0-9) enter the time interval at which the stepper **MUST** advance, *regardless* of **SAMPLE INITIATION** settings. The program will repeat this action at the set interval *except* during an ongoing sample cycle, when it will advance the stepper after the sample cycle is complete.



```
PROGRAM TYPE
<ENTERED>
```

Press **ENTER**. The display now reads PROGRAM TYPE <ENTERED>.



The controller has now been given a new value for **PROGRAM TYPE**. The new value resides in the NEW ENTRIES area of the controller memory. To make these changes active, press the **RESTART** key, then again press it to confirm your choice. The controller will then be set to perform as a Timed Step Sampler in conjunction with the parameters programmed under the **START DELAY** and **SAMPLE INITIATION** variables.

Summary of Sequence:
SET, PROGRAM TYPE, ARROW(S), ENTER, ENTER, ####, ENTER, RESTART, RESTART.

5.6 Programming OTHER OPTIONS



5.6.1 OTHER OPTIONS Overview

SET or VIEW

OTHER OPTIONS Clock	This feature allows the user to SET or VIEW the internal Real-Time clock of the microprocessor.
OTHER OPTIONS Purge Time	This feature allows the user to SET or VIEW the duration for which the sampler will purge the intake line prior to drawing in a sample to the chamber. The maximum allowable setting is 99 seconds.
OTHER OPTIONS Pinch Valve	This feature allows the user to change how the pinch valve will operate during sampling cycles. Depending on which generation of sampler the controller is to be used on determines the setting. If this is a new unit, the pinch valve action will have been factory set. Should the controller be used as a retrofit into an older model, the setting may have to be changed. If the sampler has a pinch valve that squeezes shut the discharge tube even during an inactive state, this model is termed as normally closed. Should the tubing be shut only when the pinch valve is energized, it is termed normally open. This is the ONLY setting for the PVSsamplers.
OTHER OPTIONS Fault Shutdown	This feature will enable or disable the ability of the controller to cease operations when it encounters repeated difficulties in the drawing of samples. The controller normally will attempt to obtain a valid sample by repetition of its programming with extended purge times and vacuum cycles, also extending the time allowed for the acquisition of the sample. When a sample is not obtained, this fact is noted in the controller memory and the program resumes. If after two (2) successive attempts have failed, the controller will Shut Down, halting sampling until operator intervention clears any reason for fault and RESTARTs the program. This is not always a required course of action. If FAULT SHUTDOWN is disabled, the program will record all failures to obtain samples and without further

	attempts being made to obtain the failed sample, will wait until the next sample initiation.
--	--

VIEW ONLY

OTHER OPTIONS Sampler Status	The controller will remember conditions encountered during normal operation. Reasons for premature ending of a set program will also be saved in memory. By VIEWing this feature, this information can be obtained at the time the sampler is checked.
OTHER OPTIONS Cycles Abandoned	Values retained by the controller to indicate number of missed samples.
OTHER OPTIONS Bottle Position	When equipped with the appropriate hardware and with the controller running the proper program (i.e. Multi-Composite), the current position of the distributor arm can be determined by VIEWing this option. The position information is relative to the original position of the arm at the beginning of the program start. <i>Note: There is no physical "Bottle 1", any bottle can be determined to be #1 at the beginning of a sample program.</i>
OTHER OPTIONS Maintenance	The following selections are all available under the maintenance heading and are all for VIEWing only. To check any of these values or perform any tests, press VIEW , then OTHER OPTIONS . Arrow left or right as required until the flashing text <i>MAINTENANCE</i> appears and press ENTER . Once more, arrow left or right until the desired flashing text appears, and press ENTER .
MAINTENANCE Serial Number	Displays the microprocessor's serial number.
MAINTENANCE B/U Battery Test	Tests the controller's on-board lithium battery.
MAINTENANCE Keypad Test	Tests the touchpad keys.
MAINTENANCE Memory Check	Checks the main IC's read / write integrity.
MAINTENANCE Analogue Channels	<i>Technicians Only!</i> Digital Feedback from two on-board A/D channels. Channel 1: 4-20mA Input Channel 2: Displays Float Voltage

5.6.2 OTHER OPTIONS - Clock

OTHER OPTIONS
Clock

The following sequence of entries are made on the Touchpad to alter the **Real Time Clock**, running internally in the controller, which is the basis for all timed functions. The ACTIVE SETTINGS are not being altered and there are no NEW ENTRIES generated.

SET

1. Press the **SET** key.

OTHER
3
OPTIONS

2. Press the **OTHER OPTIONS** key.

MANUAL
➔
SAMPLE

3. Press an **ARROW** key. Continue until **Clock** is shown on the display (for updating the internal Real Time Clock).

ENTER

4. Press the **ENTER** key.

08:44 AM Wed
26-May-10

The display shows a time / date response in the form of “01:23 AM SUN 01-Jan-92”. The flashing digits are changed, if necessary, by use of the number keys (0-9) in the same manner as a standard watch, in the HH:MM format. Maximum values are 01 - 12 for the hours pair and 00 to 59 for the minutes. However, each digit is set separately.

ENTER

Press **ENTER**. The display will shift its flashing prompt to the AM/PM pair. Since both characters are flashing, the selection is made by use of the **ARROW** keys. The selection cycles through AM and PM repeatedly. Choose one.

MANUAL
➔
SAMPLE

Press **ENTER**. The display will shift its flashing prompt to the three characters forming the day of the week. Since all three characters are flashing, the selection is made by use of the **ARROW** keys. The selection cycles through the 7 days. Choose one.



Press **ENTER**. The bottom line of the display shows a date in the format DD-MM-YY. The DD pair is a pair of digits with the normal range of 00 - 31. Set by number keys (0-9) individually.

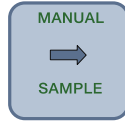

Press **ENTER**. The MM characters are set using the **ARROW** keys for the choice of one regular calendar month.



Press **ENTER**. The YY pair of digits are set using the number keys again, corresponding to the last two digits in the year. Set each digit individually. Press **ENTER**. The date as entered is now checked by the internal clock. An invalid date will return the prompt to the beginning of the date setting, after an error message is displayed. It can then be corrected and re-entered.



The display now reads CLOCK <ENTERED>.

The controller has now been given a new value for the **REAL TIME CLOCK**. The new value is in use immediately, once set.

Summary of Sequence:
SET, OTHER OPTIONS, ARROW(S), ENTER, ##, ##, ENTER, ,
ARROWS, ENTER, ARROWS, ENTER, ##, ENTER, ARROWS,
ENTER, ##, ENTER.

5.6.3 OTHER OPTIONS - Purge Time

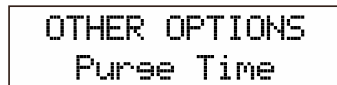

The following sequence of entries are made on the Touchpad to describe how the Sampler controller is to operate some of the hardware specified in its configuration. The ACTIVE SETTINGS are not being altered.



1. Press the **SET** key.

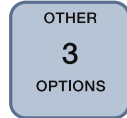

2. Press the **OTHER OPTIONS** key.

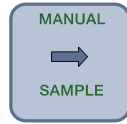

3. Press an **ARROW** key. Continue until **Purge Time** is shown on the display (for operating time when the sampler is in the purge mode of the Sample cycle, pressurizing the inlet hose to clear it of obstructions and fluid).



4. Press the **ENTER** key.



The display shows the response “PURGE TIME *SS* seconds”. The first digit of *SS* is flashing. A previously set value may be displayed. Using the number keys (0-9) enter the time in seconds that will represent the basic purge time. Multiples of this time may be used by the controller to facilitate the removal of obstructions in the inlet hose.



Press **ENTER**. The display now reads PURGE TIME <ENTERED>.



The controller has now been given a new value for **PURGE TIME**. The new value resides in the NEW ENTRIES area of the controller memory. To make these changes active, press the **RESTART** key, then again press it to confirm your choice. The controller will then be set to perform in conjunction with the parameters programmed under the **START DELAY**, **SAMPLE INITIATION** and **PROGRAM TYPE** settings.

Summary of Sequence:
SET, OTHER OPTIONS, ARROW(S), ENTER, ##, ENTER, RESTART, RESTART.

5.6.4 OTHER OPTIONS - Pinch Valve

```
OTHER OPTIONS
Pinch Valve
```

The following sequence of entries are made on the Touchpad to describe how the Sampler controller is to operate some of the hardware specified in its configuration. The ACTIVE SETTINGS are not being altered.

```
SET
```

1. Press the **SET** key.

```
OTHER
3
OPTIONS
```

2. Press the **OTHER OPTIONS** key.

```
MANUAL
→
SAMPLE
```

3. Press an **ARROW** key. Continue until **Pinch Valve** is shown on the display.

```
ENTER
```

4. Press the **ENTER** key.

*The **Pinch Valve** option is for control of the solenoid activated pinch bar determining vacuum / pressure modes in the sampler operation. This is a factor usually set at the factory because it relates directly to the equipment specification. It is alterable only to facilitate the use of the controller in plants that have a variety of equipment configurations.*

```
PINCH VALVE
Normally Open
```

The display will show the response “PINCH VALVE Normally Open / Closed”. All the characters on the bottom line are flashing, therefore the choice is made with the **ARROW** keys. The choice is a toggle between ‘Open’ and ‘Closed’. It represents the state of the pinch valve when the equipment is idle. *Note: The sampler will not perform properly if this setting is in error.*

```
ENTER
```

Press **ENTER**. The display now reads PINCH VALVE <ENTERED>.

```
PINCH VALVE
<ENTERED>
```



The controller has now been given a new value for **PINCH VALVE**. The new value resides in the **NEW ENTRIES** area of the controller memory. To make these changes active, press the **RESTART** key, then again press it to confirm your choice. The controller will then be set to perform in conjunction with the parameters programmed under the **START DELAY**, **SAMPLE INITIATION** and **PROGRAM TYPE** settings.

Summary of Sequence:
SET, OTHER OPTIONS, ARROW(S), ENTER, ARROW(S), ENTER, RESTART, RESTART.

5.6.5 OTHER OPTIONS - Fault Shutdown

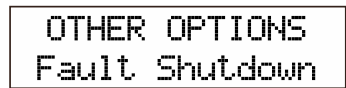

The following sequence of entries are made on the Touchpad to describe how the Sampler controller is to operate some of the hardware specified in its configuration. The **ACTIVE SETTINGS** are not being altered.



1. Press the **SET** key.

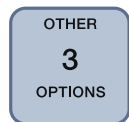

2. Press the **OTHER OPTIONS** key.



3. Press an **ARROW** key. Continue until **Fault Shutdown** is shown on the display..



4. Press the **ENTER** key.

***Fault Shutdown** is used to control whether the sampler will cease taking samples after a predetermined number of unsuccessful attempts.*

FAULT SHUTDOWN
Enabled

The display will show the response “FAULT SHUTDOWN Enabled / Disabled”. All the characters on the bottom line are flashing, therefore the choice is made with the **ARROW** keys. The choice is a toggle between ‘Enabled’ or ‘Disabled’. If disabled, the controller will make a lengthy attempt to obtain a sample, then return control to the **SAMPLE INITIATION** to try again. The controller will accumulate a count of unsuccessful (abandoned) attempts.

ENTER

Press **ENTER**. The display now reads FAULT SHUTDOWN <ENTERED>.

FAULT SHUTDOWN
<ENTERED>

RESTART RESTART

The controller has now been given a new value for **FAULT SHUTDOWN**. The new value resides in the **NEW ENTRIES** area of the controller memory. To make these changes active, press the **RESTART** key, then again press it to confirm your choice. The controller will then be set to perform in conjunction with the parameters programmed under the **START DELAY**, **SAMPLE INITIATION** and **PROGRAM TYPE** settings.

Summary of Sequence:
SET, OTHER OPTIONS, ARROW(S), ENTER, ARROW(S), ENTER, RESTART, RESTART.

5.7 Viewing Information

5.7.1 Viewing Programmed Information



To see current settings, press the **VIEW** button, followed by the appropriate button as described on its label.

The display will show current parameter settings, beginning with the requested major category.



Press the **ENTER** key. If more information is available for a given parameter, it will be displayed. Continue pressing **ENTER** until no new information is presented. The display will “wrap-around” to its first message. Where timing or counting are used, active values will be shown which can be used to monitor the progress of the parameter.

START DELAY

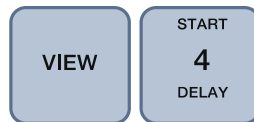

Press the **VIEW** key.

Press the **START DELAY** key.

Sequence: **VIEW, START DELAY, ENTER, (ENTER).**

SAMPLE INITIATION

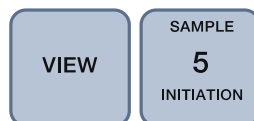

Press the **VIEW** key.

Press the **SAMPLE INITIATION** key.

Sequence: **VIEW, SAMPLE INITIATION, ENTER, (ENTER).**

PROGRAM TYPE

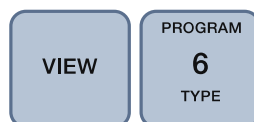

Press the **VIEW** key.

Press the **PROGRAM TYPE** key.

Sequence: **VIEW, PROGRAM TYPE, ENTER, (ENTER).**

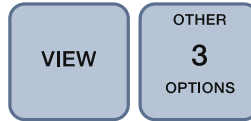
OTHER OPTIONS

Press the **VIEW** key.

Press the **OTHER OPTIONS** key.

Use **ARROW** keys to navigate to desired option on the flashing display.

Press **ENTER** to view.

Available options are:

- Clock** - Time, Date (including Day)
- Purge Time** - Time in seconds
- Pinch Valve** - Normally Open or Closed
- Fault Shutdown** - Enabled or Disabled
- Sampler Status** - Error and system messages that have been lost from the display by keyboard entry.
- Cycles Abandoned** - Counter
- Bottle Position** - Relative position of distributor,
- Maintenance**
 - **Serial Number** - unit identification No.,
 - **Analog channels** - A/D output display,
 - **Backup battery test** - test of onboard Lithium battery,
 - **Memory check** - test of controller RAM/ROM locations.
 - **Keypad Check** - test of touchpad

(Under **Maintenance**, **ARROW** to selection, then display with **ENTER**.)

ACTIVE SETTINGS

Press the **VIEW** key.

Press the **ACTIVE SETTINGS** key.

The display will show “ACTIVE SETTINGS ‘ENTER’ to list”.

Press the **ENTER** key. The display will show the **START DELAY** programming.

Continuously pressing the **ENTER** key will display all of the active program selections and return to the original display.

Sequence: **VIEW**, **ACTIVE SETTINGS**, **ENTER(S)**

NEW ENTRIES

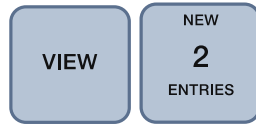

Press the **VIEW** key.

Press the **NEW ENTRIES** key.

If no “NEW ENTRIES” have been made, the display will show “No New Entries View Active Set”. If new parameters have been set, but the unit hasn’t been **RESTART**ed, the display will show “NEW ENTRIES ‘ENTER’ to list”. Press the **ENTER** key. The display will show the **START DELAY** programming. Continuously pressing the **ENTER** key will display all of the program selections, **SUBSTITUTING** new parameters where they’ve been changed, and return to the original display.

Sequence: **VIEW, NEW ENTRIES, ENTER(S)**

5.7.2 Viewing Generated Information

The following sequence of entries are made on the Touchpad to examine the sample information collected or generated by the controller and stored in its memory.

SAMPLES TAKEN

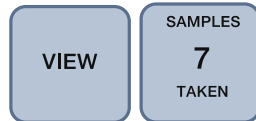

Press the **VIEW** key.

Press the **SAMPLES TAKEN** key.

The display will show a count of all samples taken during the current program. To make these changes active, press the **RESTART** key, then again press it to confirm your choice. The controller will then wait until the designated time before starting its sampling program.

REMAINING PULSES

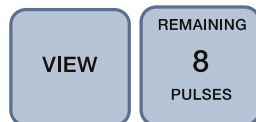

Press the **VIEW** key.

Press the **REMAINING PULSES** key.

The display will show a countdown of incoming pulses, decreasing from the programmed value. Only available when either **START DELAY** or **SAMPLE INITIATION** are using their Pulse Input options or pulses generated by the 4-20mA input option. The information is updated continuously and can be left on the display as a progress indicator.

Sequence: **VIEW, REMAINING PULSES.**

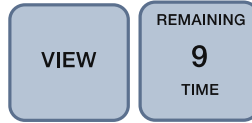
REMAINING TIME

Press the **VIEW** key.

Press the **REMAINING TIME** key.

The display will show various time counters dependent on the programming of the START DELAY and SAMPLE INITIATION parameters. Priority goes to START DELAY, which will show an incrementing time for *event related* delays or decrementing time for *time related* delays. The display will then yield to SAMPLE INITIATION for an elapsed time display for **event related** inputs and Remaining Time display for **time related** inputs.

Sequence: **VIEW, REMAINING TIME.**

Appendix A. Principles of Operation

Switching Methods (Sinking / NPN)

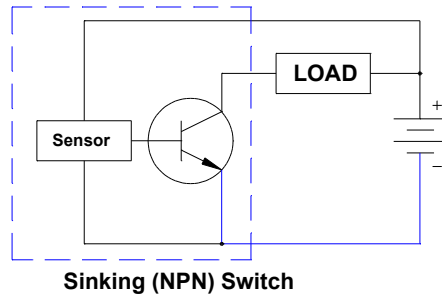

The **Sinking** method connects or switches one side of the load to the negative (-) side of the power supply. The positive (+) side is connected directly to the other side of the load as shown. “**NPN**” refers to the type of transistor used to act as a switch in this type of solid-state sensor.

Switching Methods (Sourcing / PNP)

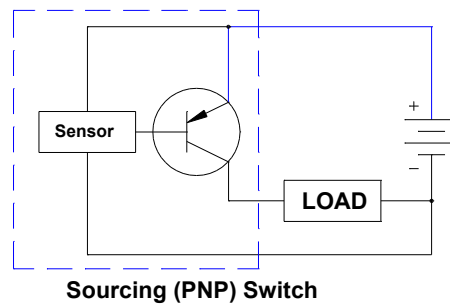

The **Sourcing** method connects or switches one side of the load to the positive (+) side of the power supply. The negative (-) side is connected directly to the other side of the load as shown. “**PNP**” refers to the type of transistor used to act as a switch in this type of solid-state sensor.

Appendix B. Parts List

This is a partial list of most frequently requested PVS Sampler replacement parts.

TABLE B-1. PVS Replacement Parts		
Part No.	Old Part No. (Prior to 8-1-11)	Description
SAMPLE CONTAINERS		
27952	27-01-01	500cc Wedge (Polypropylene)
27953	27-01-02	1000cc Wedge (Polypropylene)
26897	27-03-05	2.3 Gallon (9L) Nalgene with side plug (Polyethylene)
28258	27-03-05P	2.3 Gallon (9L) Nalgene with side plug (Polypropylene)
	27-03-05-4150	2.3 Gallon (9L) Nalgene with side plug for PVS4150 (HDPE)
27956	27-03-07	2.5 Gallon (10 L) Glass with Teflon Cap
26900	22-10-32	Discrete Bottle Tray (24-Bottle x 500cc)
SINKER / STRAINER		
26915	23-28-01-3/8	Sinker (Lead): 3/8 System
27820	23-28-01-5/8	Sinker (Lead): 5/8 System
27821	23-28-10	Sinker Strainer (Stainless Steel): 5/8 System
26914	23-28-11	Sinker Strainer (Stainless Steel): 3/8 System
27821	23-28-12	Sinker (Stainless Steel): 3/8 System
27938	23-28-13	Sinker (Stainless Steel): 5/8 System
INTAKE TUBE		
26904	26-01-16	PVC Standard: 3/8" ID (per foot)
27819	26-01-18	PVC Standard: 5/8" ID (per foot)
	26-01-14	Teflon: 1/2" ID (Minimum 25 Ft)
	26-01-09	Teflon: 3/4"ID (Minimum 25 Ft)
INTAKE TUBE WITH SINKER/STRAINER		
27949	26-02-01	PVC: 3/8"ID: 25 Ft with Lead Sinker
26925-L50-E1	26-02-01-050	PVC: 3/8"ID: 50 Ft with Lead Sinker
26925-L100-E1	26-02-01-100	PVC: 3/8"ID: 100 Ft with Lead Sinker
26925-L150-E1	26-02-01-150	PVC: 3/8"ID: 150 Ft with Lead Sinker
26926-L25-E1	26-02-02	PVC: 5/8"ID: 25 Ft with Lead Sinker

26926-L50-E1	26-02-02-050	PVC: 5/8"ID: 50 Ft with Lead Sinker
26926-L100-E1	26-02-02-100	PVC: 5/8"ID: 100 Ft with Lead Sinker
26926-L150-E1	26-02-02-150	PVC: 5/8"ID: 150 Ft with Lead Sinker
	26-02-03	Teflon: 1/2" ID: 25 Ft with SS Sinkers
	26-02-03-050	Teflon: 1/2" ID: 50 Ft with SS Sinkers
	26-02-11	Teflon: 3/4" ID: 25 Ft with SS Sinkers/Strainer
	26-02-21	Teflon: 1/2" ID: 25 Ft with SS Sinkers/Strainer
DISCHARGE TUBE		
26898	26-03-01	Discharge Tubing (Latex): 3/8" ID: 3 Ft
27957	26-03-06	Discharge Tubing (Latex): 5/8" ID: 3 Ft
28251	26-03-11	Discharge Tubing (Silicone): 5/8" ID: 3 Ft
26899	26-03-12	Discharge Tubing (Silicone): 3/8" ID: 3 Ft
METERING CHAMBER		
	50-01-01-MR	Metering Chamber Assembly (complete): 3/8 System, 500cc
	50-01-08-MR	Metering Chamber Assembly (complete): 5/8 System, 500cc
26906	24-01-01	Metering Chamber (Acrylic): 3/8 System, 500cc
27941	24-01-02	Metering Chamber (Acrylic): 5/8 System, 500cc
26905	24-01-08	Metering Chamber (Pyrex): 3/8 System, 500cc
27942	24-01-10	Metering Chamber (Pyrex): 5/8 System, 500cc
	50-21-01	Metering Chamber Cover: 3/8 Delrin
	50-21-04	Metering Chamber Cover: 5/8 Delrin
	50-21-06	Metering Chamber Cover: 3/8 Teflon
	50-21-07	Metering Chamber Cover: 5/8 Teflon
26918	23-03-01	Volume Control Tube: 3/8 System, 500cc
26919	23-03-04	Volume Control Tube: 5/8 System, 500cc
28224	23-37-01	Liquid Sensing Rod for Metering Chamber: 500cc
26909	28-05-01	O-Ring: Barrier Valve (Buna-N)
26908	28-05-02	O-Ring: Metering Chamber (Buna-N)
26910	28-05-03	O-Ring: Barrier Valve (Viton)
26907	28-05-04S	O-Ring: Metering Chamber (Silicone)
26911	28-05-04	O-Ring: Metering Chamber (Viton)

VACUUM PUMP		
28006	32-01-01	Vacuum Pump - 12VDC
28009	32-02-05	Pump Assembly (including solenoids and fixtures) - 12VDC
26895	32-08-10	Brush & Lead Wire Kit (for 32-01-01)
	32-10-01	Pump Kit with Flap & Diaphragms
DISTRIBUTOR / STEPPER		
28287	32-04-01	Distributor (Teflon)
28011	32-05-01	Stepper Motor
28296	32-06-01	Distributor (PVC)
OTHER COMPONENTS		
28005	30-DC-MFCB	Multi-Function Input Controller (12VDC)
28012	50-02-13	Pinch Valve Assembly (12VDC All Systems)
27997	28-11-41	Quick Connector Stem (SS): 1/2"
27998	28-11-42	Quick Connector Body (SS): 1/2"
	28-11-43	Quick Connector Stem (SS): 3/4"
	28-11-44	Quick Connector Body (SS): 3/4"
	MANUAL	Hard Copy of Manual
26926	55-15-12	Battery: Large 12VDC, 17AH, 15 lbs
6053	55-15-40	Battery: Small 12VDC, 7AH, 4 lbs
28020	55-15-23	Switching Power Supply c/w Filtering Capacitor: INPUT: 88 - 264 VAC, 50/60 Hz. 2.5 Amps OUTPUT: 13.6 VDC, 10 Amps.

Appendix C. Programming 4-20mA for Flow Proportional Sampling

In order to use the 4-20mA interface with a PVS Sampler, calculations must be made based on flow. The 4-20mA input is a signal that corresponds to the flow meter's output. 20mA is equal to the maximum flow, and 4mA is equal to the minimum flow. The controller requires a number which reflects the maximum flow going through the sampler.

The PVS Controller generates 100 pulses per minute internally at the maximum flow. This number decreases with the amount of flow proportional to the 4-20mA scale. The Controller requires the number of pulses at maximum flow. In order to calculate this, use the following formula:

1. Calculate Q. Q = Average flow rate divided by the maximum flow rate.

$$Q = \frac{\text{Average Flow Rate}}{\text{Maximum Flow Rate}}$$

2. Calculate t .

$$t = \frac{\text{Volume between samples}}{\text{Average volume per minute}}$$

t is the number of minutes per sample you would like for an average flow rate. Either choose how long between samples you'd like for average flow, or calculate based on volume above.

3. Multiply $Q \times t \times 100$ (100 pulses at max flow)

This is the number you will input into the Controller at the 4-20mA dialogue.

Example

You want to collect samples every 30 minutes. On average 175gal/min flows by. Maximum is 300gal/min.

1. Calculate Q.

$$Q = \frac{\text{Average Flow Rate}}{\text{Maximum Flow Rate}} = \frac{175 \text{ gal/min}}{300 \text{ gal/min}} = .58333$$

2. Calculate t .

$$t = 30 \text{ min/sample or } \frac{5250 \text{ Gallons btwn samples}}{\text{Average } 175 \text{ gal/min}}$$

3. Multiply $Q \times t \times 100$ pulses = 1750 pulses/sample

Enter 1750 into the Controller at the 4-20mA dialogue.

Campbell Scientific Companies

Campbell Scientific, Inc. (CSI)

815 West 1800 North
Logan, Utah 84321
UNITED STATES
www.campbellsci.com • info@campbellsci.com

Campbell Scientific Africa Pty. Ltd. (CSAf)

PO Box 2450
Somerset West 7129
SOUTH AFRICA
www.csafrica.co.za • cleroux@csafrica.co.za

Campbell Scientific Australia Pty. Ltd. (CSA)

PO Box 8108
Garbutt Post Shop QLD 4814
AUSTRALIA
www.campbellsci.com.au • info@campbellsci.com.au

Campbell Scientific do Brazil Ltda. (CSB)

Rua Luisa Crapsi Orsi, 15 Butantã
CEP: 005543-000 São Paulo SP BRAZIL
www.campbellsci.com.br • suporte@campbellsci.com.br

Campbell Scientific Canada Corp. (CSC)

11564 - 149th Street NW
Edmonton, Alberta T5M 1W7
CANADA
www.campbellsci.ca • dataloggers@campbellsci.ca

Campbell Scientific Centro Caribe S.A. (CSCC)

300 N Cementerio, Edificio Breller
Santo Domingo, Heredia 40305
COSTA RICA
www.campbellsci.cc • info@campbellsci.cc

Campbell Scientific Ltd. (CSL)

Campbell Park
80 Hathern Road
Shepshed, Loughborough LE12 9GX
UNITED KINGDOM
www.campbellsci.co.uk • sales@campbellsci.co.uk

Campbell Scientific Ltd. (France)

3 Avenue de la Division Leclerc
92160 ANTONY
FRANCE
www.campbellsci.fr • info@campbellsci.fr

Campbell Scientific Spain, S. L.

Avda. Pompeu Fabra 7-9, local 1
08024 Barcelona
SPAIN
www.campbellsci.es • info@campbellsci.es

Please visit www.campbellsci.com to obtain contact information for your local US or International representative.