

***PConnect
for Palm Handheld
Software Support***

User Manual

Issued 10.2.10

Copyright © 2001-2009 Campbell Scientific Inc.
Printed under licence by Campbell Scientific Ltd.

Licence for Use

The software is protected by both United States copyright law and international copyright treaty provisions. You may copy it onto a computer to be used and you may make archival copies of the software for the sole purpose of backing up Campbell Scientific Ltd. software and protecting your investment from loss. All copyright notices and labelling must be left intact.

The software may be used by any number of people, and may be freely moved from one computer location to another so long as there is no possibility of it being used at one location while it's being used at another. Under the terms of this licence, the software cannot be used by two different people in two different places at the same time.



Campbell Scientific Ltd,
Campbell Park, 80 Hathern Road,
Shepshed, Loughborough, LE12 9GX, UK
Tel: +44 (0) 1509 601141
Fax: +44 (0) 1509 601091
Email: support@campbellsci.co.uk
<http://www.campbellsci.co.uk>

Limited Guarantee

The following warranties are in effect for ninety (90) days from the date of shipment of the original purchase. These warranties are not extended by the installation of upgrades or patches offered free of charge.

Campbell Scientific warrants that the installation media on which the software is recorded and the documentation provided with it are free from physical defects in materials and workmanship under normal use. The warranty does not cover any installation media that has been damaged, lost, or abused. You are urged to make a backup copy (as set forth above) to protect your investment. Damaged or lost media is the sole responsibility of the licensee and will not be replaced by Campbell Scientific.

Campbell Scientific warrants that the software itself will perform substantially in accordance with the specifications set forth in the instruction manual when properly installed and used in a manner consistent with the published recommendations, including recommended system requirements. Campbell Scientific does not warrant that the software will meet licensee's requirements for use, or that the software or documentation are error free, or that the operation of the software will be uninterrupted.

Campbell Scientific will either replace or correct any software that does not perform substantially according to the specifications set forth in the instruction manual with a corrected copy of the software or corrective code. In the case of significant error in the installation media or documentation, Campbell Scientific will correct errors without charge by providing new media, addenda, or substitute pages. If Campbell Scientific is unable to replace defective media or documentation, or if it is unable to provide corrected software or corrected documentation within a reasonable time, it will either replace the software with a functionally similar program or refund the purchase price paid for the software.

All warranties of merchantability and fitness for a particular purpose are disclaimed and excluded. Campbell Scientific shall not in any case be liable for special, incidental, consequential, indirect, or other similar damages even if Campbell Scientific has been advised of the possibility of such damages. Campbell Scientific is not responsible for any costs incurred as a result of lost profits or revenue, loss of use of the software, loss of data, cost of re-creating lost data, the cost of any substitute program, telecommunication access costs, claims by any party other than licensee, or for other similar costs.

This warranty does not cover any software that has been altered or changed in any way by anyone other than Campbell Scientific. Campbell Scientific is not responsible for problems caused by computer hardware, computer operating systems, or the use of Campbell Scientific's software with non-Campbell Scientific software.

Licensee's sole and exclusive remedy is set forth in this limited warranty. Campbell Scientific's aggregate liability arising from or relating to this agreement or the software or documentation (regardless of the form of action; e.g., contract, tort, computer malpractice, fraud and/or otherwise) is limited to the purchase price paid by the licensee.

Contents

*PDF viewers note: These page numbers refer to the printed version of this document.
Use the Adobe Acrobat® bookmarks tab for links to specific sections.*

1. Introduction	1
1.1 Contents of Shipment.....	2
2. Software Installation	2
3. Connecting Your Palm Handheld to the Datalogger	4
3.1 Direct Serial Connection	4
3.1.1 CS I/O Port Connection.....	4
3.1.2 RS-232 Port Connection.....	5
3.2 RF400 Radio Communication.....	5
3.3 IR Communication	6
3.4 Bluetooth.....	6
4. Using the PConnect Software	7
4.1 Configuring Stations	7
4.2 Connecting to the Station.....	10
4.3 Viewing Data on the Handheld.....	19
4.4 Viewing Files	20
4.5 Transferring Data to Your Desktop Computer.....	21
4.6 PConnect Settings	21
4.7 Updating Table Definitions for PakBus Dataloggers.....	22

PConnect for the Palm Handheld¹

1. Introduction

Welcome to *PConnect for the Palm Handheld* support software for Campbell Scientific's dataloggers. PConnect version 3.3 supports our mixed array dataloggers (CR10(X), CR500/510, CR23X, 21X, and CR7) as well as our PakBus capable dataloggers (CR10X-PB, CR23X-PB, CR510-PB, CR800/850, CR1000, CR3000, and CR200(X) Series).

PConnect software allows you to connect your Palm handheld to a Campbell Scientific datalogger to perform all of the standard datalogger support functions, including:

- check and set the datalogger clock
- send and receive datalogger programs
- view and edit input locations and labels
- set flags and ports
- collect data
- view data in tabular and graphical displays
- access the datalogger's remote keyboard mode through a terminal interface

PConnect stores collected datalogger data in the Palm handheld's internal memory or its memory expansion card. Using the data viewing feature, you can view this data while at the site. When the Palm handheld is HotSync'd with the desktop computer, this data is moved to a specified data folder on the PC. New data from each station is appended to any existing data file on the PC with the same station name.

The HotSync process also synchronizes datalogger program files (*.DLD, *.FSL, *.CR*, and *.BIN) between the PC and Palm device. Files copied to the Palm device's PConnect*palmmname* folder will automatically be transferred to the Palm during the next synchronization process. Using this process, you can store program files on the Palm device, and subsequently send them to the datalogger. With mixed array dataloggers, labels from an FSL file that matches the DLD file name will be used when viewing data. In most instances you can also retrieve programs from dataloggers to the Palm device, and use the HotSync process to copy them to the PC. If two different programs—one on the Palm device and another in PConnect's programs folder on the PC—have the same name when you HotSync, the DLD on the PC will overwrite the DLD on the Palm device.

NOTE

PConnect does not support collection from Campbell Scientific Storage Modules or Card Storage Modules.

¹ PConnect is a trademark of MeasureTek, Inc., Palm OS and HotSync are registered trademarks of Palm, Inc.

1.1 Contents of Shipment

The following items are shipped with PCConnect:

- PCConnect software CD
- PDA to CS I/O connector (for communication via a datalogger's CS I/O port)
- PCConnect/PCConnectCE PDA to RS-232 cable (for communication via a datalogger's RS-232 port)

2. Software Installation

PCConnect requires a Palm OS based handheld running Palm OS version 3.3 or higher and a PC computer running Windows 95, 98, ME, NT, 2000, or XP and Palm HotSync Manager software version 3.0 or later.

NOTE

The PDA must be capable of serial communication, and a PDA to 9-pin male serial cable must be available to connect directly to the datalogger. Some less expensive PDAs are not capable of serial communication. Alternately you can communicate via IR using an SC-IRDA purchased from CSI or via Bluetooth using a third party Bluetooth serial port adapter.

If you are upgrading from PCConnect Version 1, you must first uninstall the PCConnect software both on the computer and the Palm device, then run the new installation. If you are upgrading from Version 2 or 3, you may install the software without uninstalling.

Log on to your computer system as a user with administrative rights. Make sure that you have already installed the Palm Desktop software on your PC (it must also have been installed by the same user with administrative rights). Then, insert the PCConnect compact disk into your CD-ROM drive and run the Setup.exe program from the disk (if Autorun is enabled on your computer it will start automatically). Follow the instructions on the screen to install the software. During the installation, you will be prompted for "Destination Location" for the software (the default is c:\program files\campbellsci\pconnect). You will then be prompted to "Choose Working Folder" (default is c:\campbellsci\pconnect) which will be the directory on the PC for the *palmname* folder where the data files retrieved by PCConnect will be saved when you synchronize your Palm with the PC after data has been collected from a datalogger. This will also be the directory into which you will copy any files that should be transferred to the Palm for use with the datalogger, such as a new program file.

After you have installed the software on your PC, follow these steps to install PConnect on your Palm device:

- HotSync
- On the Palm, find the PConnect icon and start the software
- Close PConnect (i.e., return to the main Palm window)
- HotSync a second time

You must HotSync twice—first to transfer the PConnect program, and second to create the working subdirectory (for data and DLD files) for that device in the working directory (see above) on your PC. If you do not follow the HotSync sequence as noted above, you may receive errors when trying to open PConnect. In this instance, completely remove the software from the Palm device and reinstall it.

If you are updating from an earlier version of PConnect, simply run the installation on the PC from the PConnect CD and then HotSync. Data will be preserved and moved to the PC and the PConnect program will be updated on the Palm handheld.

NOTE

If you are installing the PConnect 3.4 patch, a version of PConnect 3.X must already be installed on the Palm for the patch to be successful. If you do not have Version 3.0 or greater, contact a Campbell Scientific Applications Engineer for information on purchasing an upgrade for your software.

After installation, you may change the folders for the data and program files. Click the HotSync icon on your system tool tray, choose **Custom**, then select **PConnect** and click **Change**, and then enter a new path for the data and program files. Refer to the steps below:

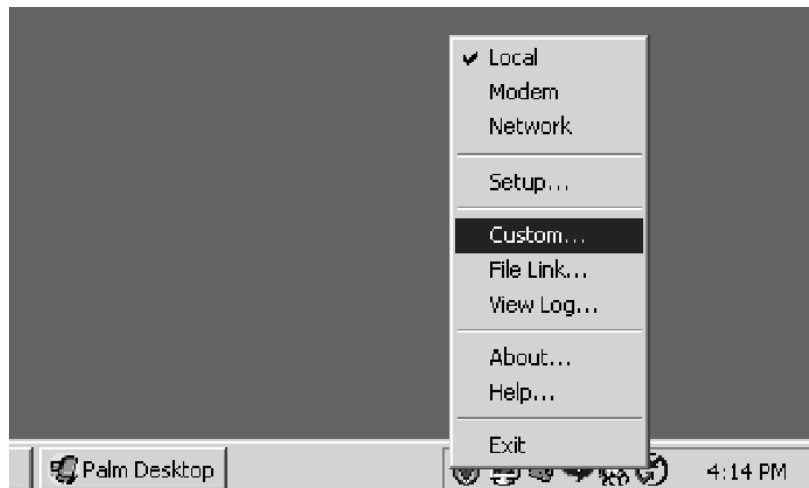
Step 1:

Step 2:

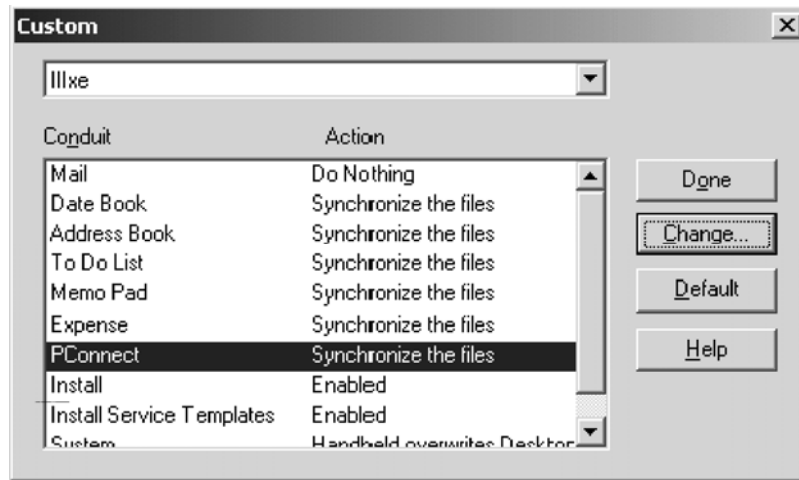

Step 3:

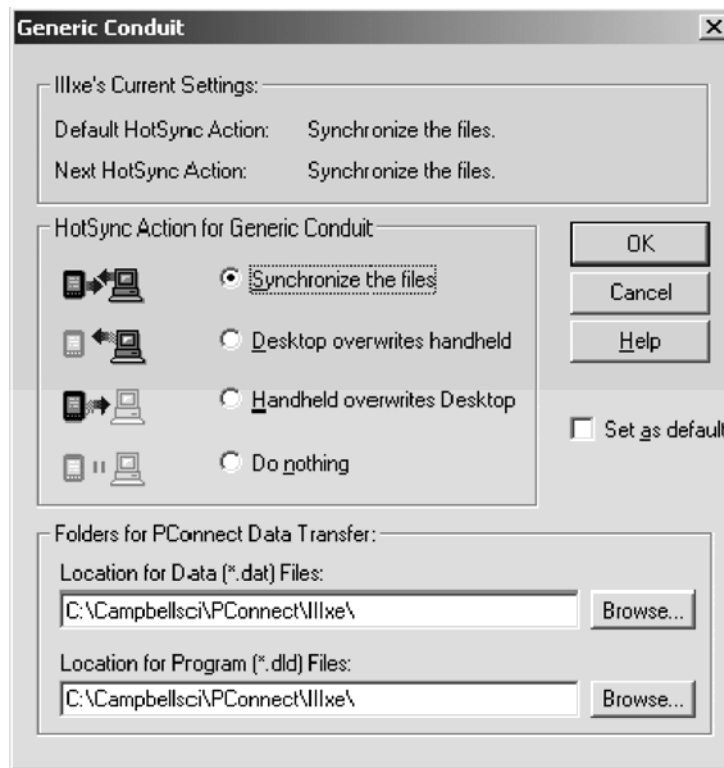

3. Connecting Your Palm Handheld to the Datalogger

3.1 Direct Serial Connection

3.1.1 CS I/O Port Connection

The most common method of connecting the Palm handheld to the datalogger is using a direct serial connection to the datalogger's CS I/O port. The Palm handheld connects to the datalogger via the communications port on the bottom of

the device. If you do not have one already, you will need to purchase a cable for your Palm handheld that connects to the PDA's communication port and terminates in a 9-pin (female) serial port connector. Since this cable is specific to each Palm OS handheld model it is not included with the PConnect software, but can be purchased separately from PDA cable retailers.

After connecting the PDA to serial cable to the bottom of the Palm handheld, use the supplied PDA to CS I/O adapter to connect to the datalogger's CS I/O port:

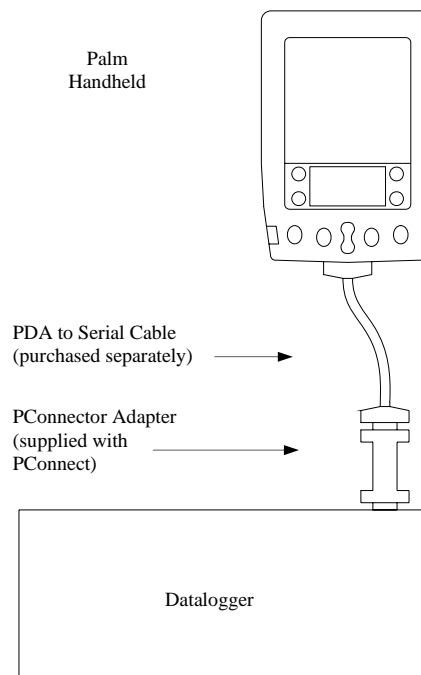

Note that one side of the connector is labelled Datalogger, and the other side is labelled PDA. If the connections are reversed, communication with the datalogger will fail.

3.1.2 RS-232 Port Connection

When connecting to a CR200(X) Series datalogger, or to the RS-232 port of the CR23X, CR1000, CR800/850, or CR3000, the PConnect PDA to RS-232 cable must be used between the Palm device and the datalogger. The PDA to CS I/O connector is not used.

The cable is connected between the PDA's cable and the datalogger's serial port (similar to the figure above).

3.2 RF400 Radio Communication

Two RF400 radios can be used to communicate with the datalogger using the Palm handheld (or one RF radio and a CR205). With this setup, the PDA to CS I/O connector is not used.

At the datalogger site, the CS I/O ports of the RF400 radio and the datalogger are connected using an SC12 or similar cable. Power for the RF400 is supplied by the datalogger's CS I/O port pin 8, which supplies 12 V.

The Palm device is connected to the base RF400 radio by using the PDA to RS-232 cable between the Palm's serial connection and the RF400's RS-232 port. An external power source will be needed for the RF400 base radio, since it cannot be powered by the Palm device.

Power supplies can be purchased from Campbell Scientific. The RF400 Base Station Kit (P/N 14220) provides an AC to 12V DC transformer for the RF400. The Field Power Cable (P/N 14291) provides a 12V DC barrel plug on one end for connection to the RF400 and two pigtailed on the other end for use with other power supplies such as a vehicle's 12V cigarette lighter accessory.

The communications protocol for the RF4xx radios must be set to Transparent mode. PConnectCE was not designed to function as a PakBus Node or work in a PakBus Aware network.

3.3 IR Communication

Campbell Scientific's SC-IRDA infrared interface device can be used to communicate with the datalogger using the Palm device's IR port and the datalogger's CS I/O port. The SC-IRDA connects directly to the datalogger's CS I/O port; the PDA to CS I/O connector is not used. Best performance is seen when the Palm is within three feet of the SC-IRDA and the two IR ports are directly aligned. The two ports must be aligned for a second or two, prior to attempting communication, to allow the two IR devices to acknowledge each other.

NOTES

IR communication is not available for CR200(X) Series dataloggers.

Some less expensive PDAs use an IR chip that is not compatible with the SC-IRDA interface. Contact Campbell Scientific for compatible chip sets.

3.4 Bluetooth

If the PDA you are using is capable of Bluetooth communication, a third party Bluetooth to serial adapter can be used to communicate with the datalogger. The adapter must be configured as Discoverable (inquiry scan) and Connectable (page scan); i.e., as a "slave" device. Most adapters are configured by default as peer-to-peer devices, and therefore must be reconfigured. Some adapters include software that is used to configure the device, others have dip switches on the outside or are configured by issuing commands using a terminal emulation program. Refer to the adapter manufacturer's information for instructions on configuration.

The interface and/or cables that are used to connect the adapter to the datalogger will vary, depending upon whether the device acts like a DTE (computer) device or DCE (PDA) device. In some instances, this is evident by the pin-out of the adapter, but not always. A general rule is if the adapter has a 9 pin female connector, then the adapter is connected to the datalogger using the PDA to CS I/O connector for the CS I/O port or the PDA to RS232 cable for the RS232 port. If the adapter has a 9 pin male connector, then the adapter is connected to the datalogger using an SC32B for the CS I/O port or it can be connected directly to the RS232 port.

Note that Bluetooth to serial adapters require a power source, typically between 5 and 12 volts. This power can be supplied from the datalogger's wiring panel, from the adapter's rechargeable battery if available, or from another external supply. If the power is provided from the datalogger's wiring panel, this additional power

consumption must be taken into account when calculating the overall power budget for the site.

4. Using the PConnect Software

4.1 Configuring Stations

Start the PConnect software on the Palm handheld. The first time you run the PConnect software, an opening screen will appear. Tap OK to clear the Welcome message. As indicated by the Welcome message, set up your first station by pressing New. A list of dataloggers will appear on the screen:



Select the type of datalogger to which you will be connecting and tap OK. The Edit Stations Parameter window will appear:



From this window you can change the station **Name**, associate a **Program**, change the **Datalogger** model, enter a **Security Code**, and select the mode of **Communication**.

The **Station** name can be any name up to 8 characters. It must contain alpha and/or numeric characters and cannot contain any spaces. You must provide a unique identity for each individual datalogger.

NOTE The following Microsoft reserved words cannot be used as station names: AUX, CON, NUL, PRN, LPT1-9, or COM1-9. The maximum number of stations that can be added is 100.

A **Program** File can be associated with the datalogger. With mixed array dataloggers, this provides labels for the input locations when viewing them on the *Measurements* window. (Note that only DLD files created with Edlog version 2.0 and greater will have these labels stored in the DLD.) If a program is already running in the datalogger and you have a copy of the DLD on the handheld, you can associate the program with the station. To select the file, press the downward pointing arrow, and choose a file. When you download a new program to the datalogger using PConnect, you will be asked if you want the label descriptions to be changed to reflect the new program.

NOTE PakBus dataloggers store data labels directly in the datalogger.

If the wrong datalogger type was selected when first setting up the station, it can be changed by pressing the arrow to the right of the **Datalogger** field and selecting the desired datalogger type. Note, however, that only similar datalogger types are presented in the pick list. That is, if the original datalogger chosen was a mixed array datalogger, then the **Datalogger** field will contain other mixed array dataloggers. If the original datalogger chosen was a PakBus datalogger only PakBus dataloggers will be listed. This is because the two types of dataloggers have somewhat different setup options. If you need to change among datalogger types, you will need to start at the beginning by going to the main window and pressing **New**.

If the datalogger type you selected was a CR510PB, CR10XPB, CR23XPB, CR800/850, CR1000, CR3000, or a CR200(X) Series datalogger, you will see a **Settings** button to the right of the **Datalogger** field. When this button is pressed, PConnect will query the PakBus datalogger for its settings and display them in a table. This information includes the PakBus address, various PakBus control codes, and information on the datalogger model and version number. CR205 Series dataloggers will also display radio settings.

NOTE CR1000, CR800/850, and CR3000 dataloggers show very little information in the resulting settings table. However, the PakBus address is retrieved and used in PConnect's Setup window.

If the datalogger type you selected was a CR510PB, CR10XPB, CR23XPB, CR1000, CR800/850, CR3000, or a CR200(X) Series datalogger, you will see a **PakBus Address** field. Enter the unique PakBus address that has been assigned to the datalogger. If you do not know the PakBus address of the datalogger, press the **Settings** button and PConnect will retrieve settings in the datalogger. When the settings window is closed, the correct address is automatically entered into the **PakBus Address** field.

Dataloggers may have up to three levels of **Security**. Security is set when creating the datalogger program or (for Edlog programmed dataloggers) in the datalogger's *C mode. If security is enabled in the datalogger, you may need to enter the security code to collect data, set the datalogger's clock, and depending upon the level of security, even to connect to the datalogger. Refer to the datalogger's user manual for complete information on security codes.

NOTE Security is not available for CR200(X) Series dataloggers.

The communication mode can be specified by selecting it from the **Communication** field. PConnect supports direct serial communication, point-to-multipoint RF400 radio communication, Campbell Scientific's SC-IRDA infrared device, and Bluetooth communication (see Section 3).



NOTE IR communication is not available for the CR200(X) Series dataloggers.

The communications protocol for RF4xx radios must be set to Transparent. PConnectCE will not be able to connect reliably with the dataloggers if PakBus Aware or PakBus Node is selected. When the RF400 is selected, an RF Net Address and an RF Radio Address must be entered. These two settings must reflect the settings in the remote RF400 radio or in the CR205. PConnect will temporarily set the RF base modem's addresses to the addresses specified, and then return them to the previous values after you disconnect.



When you are finished editing the station parameters, touch **OK**. You will be returned to the *Stations* window. PConnect has three main windows: the *Stations* window, the *Files* window, and the *PConnect Settings* window. You can navigate between the windows by pressing the window's name in the upper right corner of the screen.

If you will be using the handheld to collect data from more than one datalogger, you will need to create additional stations. To do this, press the **New** button and repeat the setup process for all dataloggers.

A station can be deleted by highlighting it and pressing the **Delete** button. You will be prompted to confirm the deletion.

4.2 Connecting to the Station

From the *Stations* window, choose a station to connect to and touch **Connect**. The *Measurements* window will appear, displaying the current input locations or public variables in the datalogger.

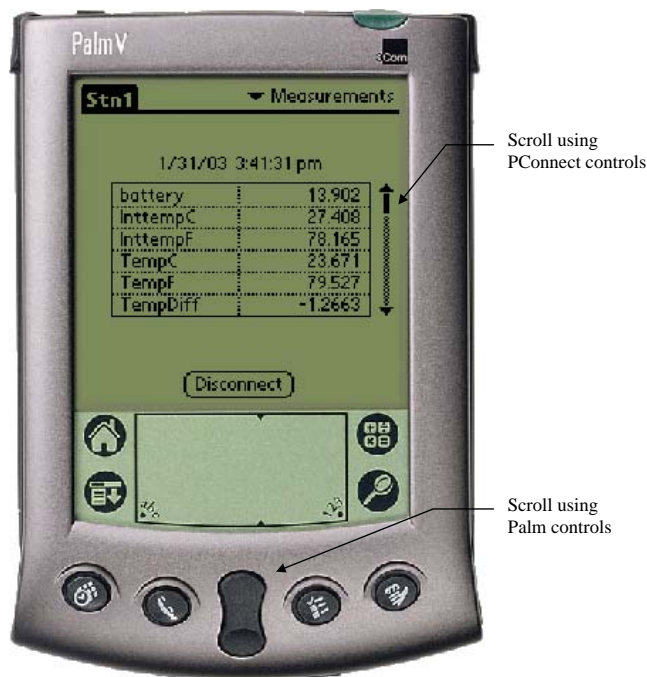

If you are connected to a PakBus datalogger, you will see a list box above the Measurement cells. This list box contains all the tables in the datalogger. Select a table from the list to view its data.

Because of the small screen size, you may see only a few of the values in the table. Touch the up or down arrows to the right of the measurement cells to scroll through the values, or use the Palm's scroll buttons to see the additional values.

The value of an input location or public variable can be changed from the *Measurements* window. Click within the cell to highlight it, press the **Edit Value** button that is displayed, enter the new value, and press **OK**. You can change the descriptive labels for the measurements by clicking within the cell, typing in a new label, and then clicking anywhere on the screen.

There are five other windows you can use to accomplish other tasks with the datalogger. They are the *Collect Data* window, the *Set Clock* window, the *Flags/Ports* window, the *Terminal* window, and the *Transfer Program* window. The CR1000, CR800/850, and CR3000 also have a *File Control* window. To select one of these windows, touch the text that reads *Measurements* in the upper right corner. The list of windows will be displayed.

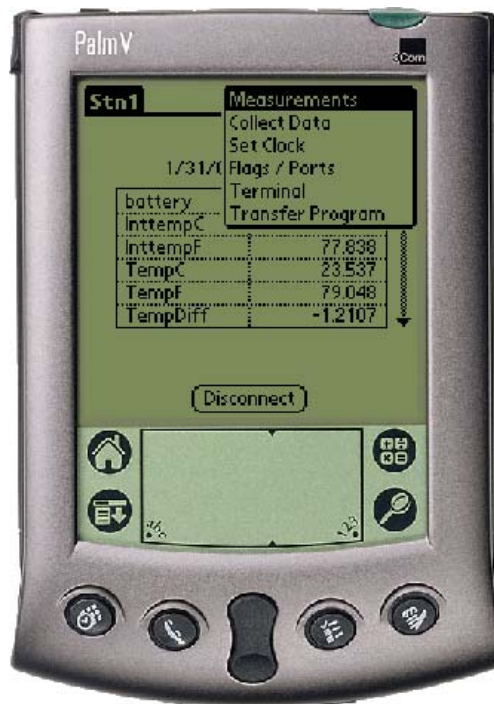

Collect Data

The *Collect Data* window is used to collect data from the datalogger and store it to a file on the handheld, which is then transferred to the computer during a subsequent HotSync operation. The data is stored in binary format on the handheld and then converted to a comma-separated ASCII format when the file is transferred to the PC during the synchronization process.

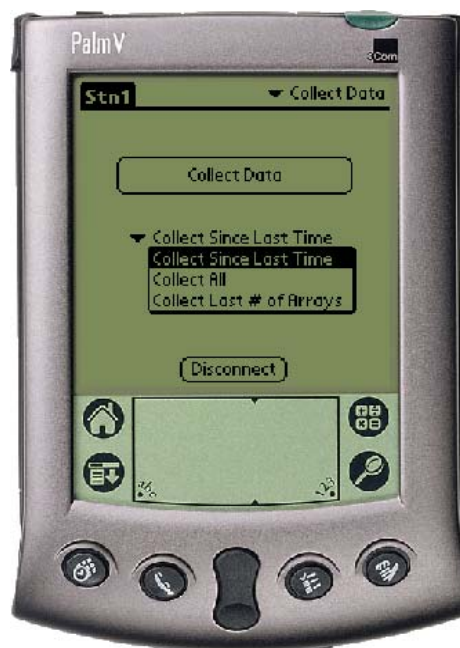

There are three data collection options:

Collect Since Last Time - This will collect only the new data that has been stored since the last time data was collected using this handheld. If this is a first data collection attempt, all data will be collected.

Collect All - This will collect all data currently in datalogger memory, regardless of whether the data has been collected previously.

Collect Last # of Arrays/Records - This will collect only the number of records or arrays entered into the Arrays/Records to Collect field that appears when the option is chosen. The maximum number of records or arrays that can be collected is 9999.

The default option is **Collect Since Last Time**. To choose another option, press the arrow to the left of the default option.

If PConnect recognizes that a memory card is installed in the Palm, a field will also be displayed to choose whether the collected data is stored on the Palm device or on the card when it is collected.

When the handheld is synchronized with the PC and the data file is transferred, the data will be appended to any *station_name.dat* data file that exists with the same name. After the file is transferred, the file is deleted from the handheld.

If the datalogger type you selected was a CR510PB, CR10XPB, CR23XPB, CR1000, CR800/850, CR3000, or a CR200(X) Series datalogger, you will see a pick list at the top of the Data Collection window which allows you to select the table(s) from which data should be collected. You can collect data from All Tables or from a single table. Data from each table will be stored on the Palm in a separate file.

Set Clock

The datalogger's clock can be set to that of the handheld's by switching to the *Set Clock* window and touching the **Set Clock** button. Note that the two clocks may not match exactly, since there will always be some delay between when the command is sent and when it is received by the datalogger.

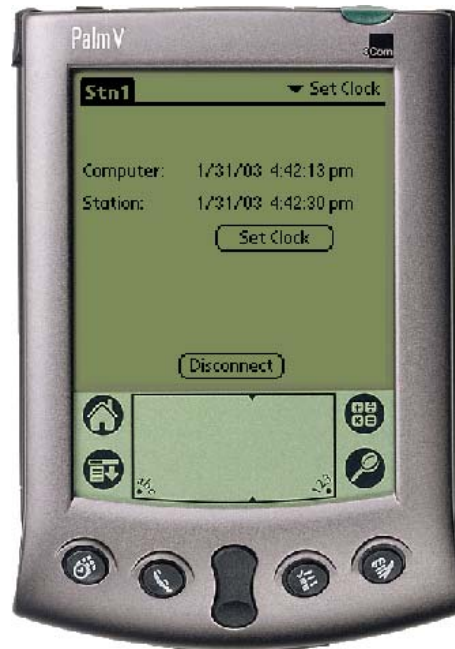

Campbell Scientific typically advises against frequent routine setting of the datalogger's clock. In most instances, the datalogger's clock will be much more accurate than the handheld's. Setting the clock could result in data with duplicate or missing timestamps, especially if data is being saved in final storage fairly quickly. For instance, assume you are storing 1 minute data. If the datalogger's clock reaches 11:45 and it stores data for that period, and then you set the clock using a handheld whose internal clock reads 11:44, you will end up with two different arrays of data with a timestamp of 11:45.

Flags/Ports

The datalogger's flags and ports can be viewed and toggled from the *Flags/Ports* window. All of the flags and ports in the datalogger are displayed on the screen. If a flag or port is High, a check mark will appear in the box beside the flag or port. If a flag or port is Low, the box will be empty.

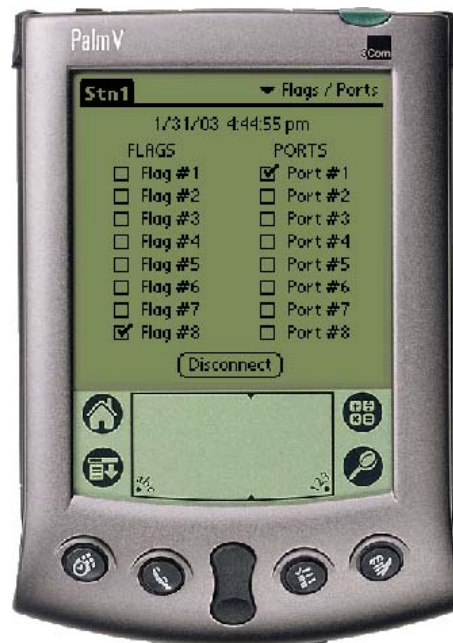

To change the state of a flag or port, touch the box for that flag or port. There may be a short delay between when the box is touched and when the state of the flag or port appears to change.

NOTES

In addition, Flags and Ports for CR510PB, CR10XPB, and CR23XPB dataloggers can be viewed and toggled from the Measurements window.

CR200(X) Series dataloggers do not have Flags or Ports which can be toggled.

Flags are displayed for the CR1000, CR800/850, or CR3000 only if the datalogger program has a Public variable array defined, with the name of flag (i.e., Flag (4)).

Terminal

When Terminal is selected, the remote communications command is sent to the datalogger and it is put into a remote communications state. This state allows the user to send telecommunications command directly to the datalogger and is typically used for trouble-shooting.



For all dataloggers except the CR1000, CR200(X), CR800/850, and CR3000, the datalogger's keyboard/display keypad is depicted on the *Terminal* window. The Palm device's graffiti pad or keyboard can also be used to enter characters. For CR1000, CR800/850, CR200(X), and CR3000 dataloggers, there is no keyboard/display depicted, so the graffiti pad or keyboard must be used.

For mixed array dataloggers, to return the datalogger to its program execution state, enter *0. LOG1, LOG2, or LOG12 should be displayed indicating that the code in program table 1, and/or program table 2, is being run. PakBus dataloggers do not need to be returned to a logging state.

Terminal mode should be used with caution since it is possible to delete instructions in the datalogger's program or delete data from the datalogger while in this mode. Refer to the datalogger's user manual for complete information on the remote communications mode.

Transfer Program

Switch to the *Transfer Program* window to send a new program file to the datalogger, or to retrieve the program file that is currently running in the datalogger.

NOTE Program files cannot be retrieved from CR200(X) Series dataloggers.

To send a program to the datalogger, press the arrow beside the program file name adjacent to the **Send** button, and then press the **Send** button. (Note that if no file has been sent or associated with the datalogger, this field may read "none".) To retrieve a program from the datalogger, enter a name into the field adjacent to the **Retrieve** button, and then press the **Retrieve** button.

Program files (*.DLD, *.FSL, *.BIN, or *.CR*) are copied to the Palm device by placing the file or files in the handheld device's Working Directory folder on the PC (by default, this is C:\campbellsci\PCconnect*Palmname*). The next time you HotSync with the handheld, the file(s) will be copied.

If you retrieve a program file from the datalogger, the next time you HotSync with the handheld, the file will be uploaded to the Working Directory for the device.

Program Transfer Considerations for CR200(X) Series Dataloggers

The CR200(X) Series datalogger is unique in that it does not have an on-board program compiler like other CSI dataloggers. This means that the CRBasic file (*.CR2) must be compiled on a computer first, and then the compiled binary file (*.BIN) must be sent to the datalogger using PConnect.

It is very important that the compiler used to generate the *.BIN file match the operating system version in the datalogger. If a *.BIN file is sent to the datalogger and the compiled version does not match the current OS, PConnect will display a message suggesting that you do not proceed with the program download.

If you receive this message, check the operating system version in the CR200(X) Series and recompile the program in CRBasic using the appropriate compiler. The most recent compiler can be downloaded from our web site. If you continue to experience problems, contact Campbell Scientific.

File Control

The File Control window is applicable only to the CR1000, CR800/850, and CR3000 dataloggers. It lets you manipulate the files that are stored on the datalogger's CPU or on a card in the datalogger if one is installed.



The device (CPU or Card) is selected from the list box at the top of the window. The files stored on the device are displayed in the field below.

Run - This option allows you to set the run attribute of a program file. Run Now begins running the selected program immediately; all of the existing data tables are deleted. Run on Start-up will set the file to run when the datalogger is powered down and powered back up. Run Now and on Startup sets both the Run Now and Run on Start-up options.

NOTE

If a program has been stopped, but data tables have been maintained, you will be presented with the options Restart Program and Run On Power-up. If you choose Restart Program, you will be asked whether to delete or maintain the existing tables.

Stop - Stops the execution of the program currently running in the datalogger. You will be asked whether to delete or maintain the existing data tables.

Pause - Temporarily pauses execution of the program. The button text changes to **Resume** until the program is started again. When a program is paused, all data tables in the datalogger are maintained.

Load - Displays a standard file dialog box from which to choose a file to be sent to the selected device. You can send a CR* program file, a voice text file, or an operating system file.

Delete - Deletes the selected file from datalogger memory.

Format - Formats the selected device. This option should be used with caution, since all files stored on the device will be lost.

4.3 Viewing Data on the Handheld

Once data is collected onto your Palm handheld, you can view it in a tabular or graphical format. Click on a station from the *Stations* window. If there is data in the handheld for that station, the **View Data** button will be enabled.



When the **View Data** button is touched, you will see either a list displaying the data files for that datalogger (PakBus dataloggers), or, the data will be shown automatically (mixed array dataloggers). For PakBus dataloggers, choose the table you would like to view. The data will be shown in tabular view.

NOTE

If the data file you are attempting to view contains more than 32,000 records, you will see the following message:

File contains more data records than can be displayed. Only the last 32,000 records will be viewable from within PConnect.

The number of records that can be displayed is a limitation of the Palm OS.

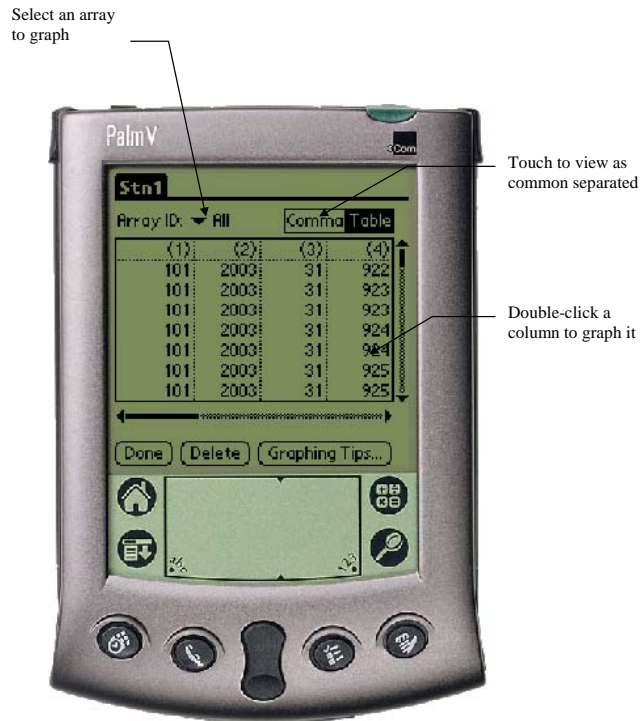

To view the data in a comma-separated format, touch the text at the upper right of the window that reads **Comma**.

As you scroll through the data for mixed array dataloggers, note that all of the collected arrays are displayed intermixed as they were retrieved from the datalogger. To graph a column of data, you must limit the display to only one array ID. Tap the Array ID drop-down arrow and select the ID of the array from which you want to graph data. Double tap the column of interest to graph it. You can scroll back and forth within the data. To see the value and the time stamp of a particular point, just tap that point.

For mixed array dataloggers if an FSL file with the same name as the DLD file name exists on the Palm, column labels, graph labels, and time stamps will be derived from the file when viewing the data. To transfer an FSL file to the Palm, place the file in the C:\Campbellsci\PConnect\palmmname directory and the file will be copied during the next HotSync operation.

A data file can be deleted from the Palm device by pressing the **Delete** button. You will be asked to confirm the deletion. A data file that has been deleted will not be transferred when the Palm device is HotSync'd with the computer, and it cannot be restored once deleted.

4.4 Viewing Files

To see the datalogger program files stored on the Palm handheld, touch the word **Stations** in the upper right corner of the *Stations* window and select **Files**.

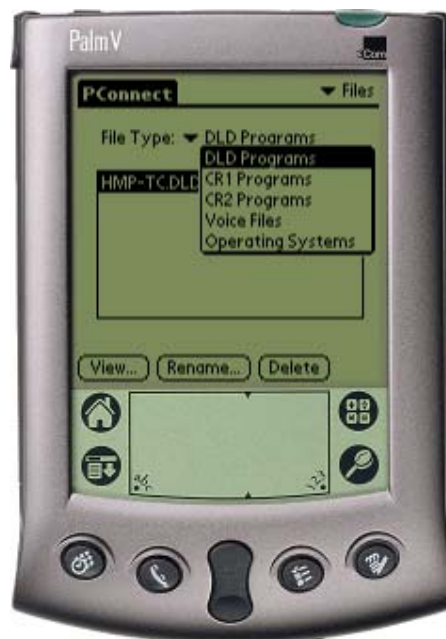

By default, the file type displayed in this window is *.DLD (Edlog program file). You can also see other files stored on the PDA, including CR1000, CR800/850, or CR3000 program files (*.CR1, *.CR8, or *.CR3), CR200(X) files (*.BIN), voice modem files (voice.txt), and datalogger operating system files (*.OBJ), by touching the File Type name and selecting the file type filter from the list.

Program files can be opened for viewing by selecting the file name and then touching View. Voice Files and Operating System files cannot be opened for viewing. All file types can be renamed or deleted by touching the corresponding word (Delete or Rename).

NOTE CR200(X) Series datalogger program files (*.BIN) are binary files and cannot be viewed.

4.5 Transferring Data to Your Desktop Computer

Once data is collected onto your Palm handheld, you can HotSync with your desktop computer and the data will automatically transfer to the folder you specified during the initial setup (default = C:\campbellsci\Pconnect\palmmname). The transferred data is saved to (or appended to) a data file on the PC **named after the station** from which it was retrieved.

4.6 PConnect Settings

For the PDA to be able to communicate with PakBus devices (CR1000, CR800/850, CR200(X), CR3000, CR10XPB, CR510PB, and CR23XPB), it must be assigned a PakBus address. The default address for the PConnect and PConnectCE software is 4091.

It is necessary that all devices participating in communication in a PakBus network be given unique PakBus addresses. Failing to do so could render one or more devices in the PakBus network unreachable for a period of time. If some other device is using 4091, and the PakBus address for PConnect needs to be changed, you can do this by selecting the word Stations in the upper right of PConnect's main window, and selecting PConnect Settings from the resulting list.

NOTE

Campbell Scientific uses the following PakBus addresses for its software:

PConnect/PConnectCE	4091
PC200W	4092
PC400	4093
LoggerNet	4094

4.7 Updating Table Definitions for PakBus Dataloggers

PakBus dataloggers have table definitions stored in internal memory. Table definitions define the structure of the data tables and the names of the associated variables. Communication software uses these table definitions to display and collect the data. If a new program is downloaded to the datalogger by some means other than PConnect, or if the program is edited in any way, the table definitions that the software has stored and the actual table definitions in the datalogger may not match. In most instances, PConnect will automatically update the table definitions. However, there may be times when PConnect displays a message asking that the table definitions be updated manually (or reset).

To manually update the table definitions, highlight the datalogger on the main Station window and select Edit. From the Station Editing window, select the Edit Station Parameter title bar, which will reveal a Tools menu, and choose Reset Table Definitions.

CAMPBELL SCIENTIFIC COMPANIES

Campbell Scientific, Inc. (CSI)

815 West 1800 North
Logan, Utah 84321
UNITED STATES

www.campbellsci.com • info@campbellsci.com

Campbell Scientific Africa Pty. Ltd. (CSAf)

PO Box 2450
Somerset West 7129
SOUTH AFRICA

www.csafrica.co.za • sales@csafrica.co.za

Campbell Scientific Australia Pty. Ltd. (CSA)

PO Box 444
Thuringowa Central
QLD 4812 AUSTRALIA

www.campbellsci.com.au • info@campbellsci.com.au

Campbell Scientific do Brazil Ltda. (CSB)

Rua Luisa Crapsi Orsi, 15 Butantã
CEP: 005543-000 São Paulo SP BRAZIL

www.campbellsci.com.br • suporte@campbellsci.com.br

Campbell Scientific Canada Corp. (CSC)

11564 - 149th Street NW
Edmonton, Alberta T5M 1W7
CANADA

www.campbellsci.ca • dataloggers@campbellsci.ca

Campbell Scientific Centro Caribe S.A. (CSCC)

300N Cementerio, Edificio Breller
Santo Domingo, Heredia 40305
COSTA RICA

www.campbellsci.cc • info@campbellsci.cc

Campbell Scientific Ltd. (CSL)

Campbell Park
80 Hathern Road
Shepshed, Loughborough LE12 9GX
UNITED KINGDOM

www.campbellsci.co.uk • sales@campbellsci.co.uk

Campbell Scientific Ltd. (France)

Miniparc du Verger - Bat. H
1, rue de Terre Neuve - Les Ulis
91967 COURTABOEUF CEDEX
FRANCE

www.campbellsci.fr • info@campbellsci.fr

Campbell Scientific Spain, S. L.

Psg. Font 14, local 8
08013 Barcelona
SPAIN

www.campbellsci.es • info@campbellsci.es

Campbell Scientific Ltd. (Germany)

Fahrenheitstrasse13, D-28359 Bremen
GERMANY

www.campbellsci.de • info@campbellsci.de