

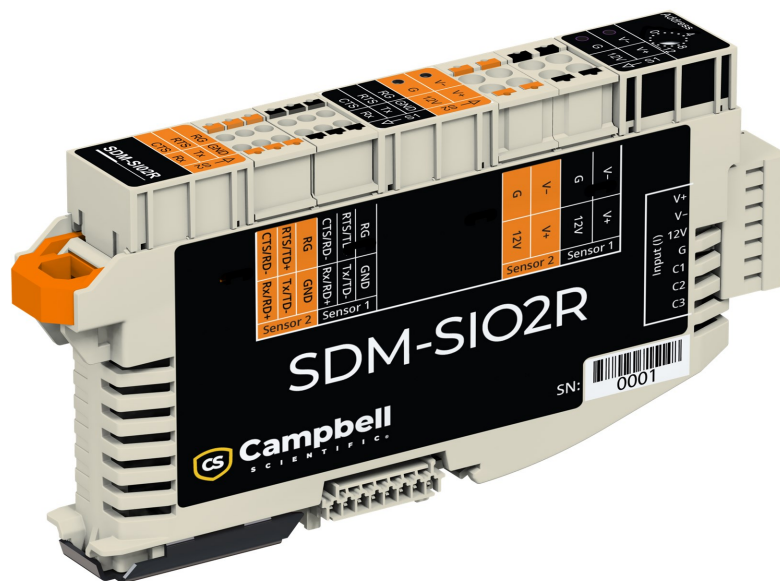

SDM-SIO2R

Serial Input/Output Module
with Switched Sensor Power



Please read first

About this manual

Please note that this manual was produced by Campbell Scientific Inc. primarily for the North American market. Some spellings, weights and measures may reflect this. In addition, while most of the information in the manual is correct for all countries, certain information is specific to the North American market and so may not be applicable to European users. Differences include the U.S. standard external power supply details where some information (for example the AC transformer input voltage) will not be applicable for British/European use. Please note, however, *that when a power supply adapter is ordered from Campbell Scientific it will be suitable for use in your country.*

Reference to some radio transmitters, digital cell phones and aerials (antennas) may also not be applicable according to your locality. Some brackets, shields and enclosure options, including wiring, are not sold as standard items in the European market; in some cases alternatives are offered.

Recycling information for countries subject to WEEE regulations 2012/19/EU



At the end of this product's life it should not be put in commercial or domestic refuse but sent for recycling. Any batteries contained within the product or used during the products life should be removed from the product and also be sent to an appropriate recycling facility, per [The Waste Electrical and Electronic Equipment \(WEEE\) Regulations 2012/19/EU](#). Campbell Scientific can advise on the recycling of the equipment and in some cases arrange collection and the correct disposal of it, although charges may apply for some items or territories. For further support, please contact Campbell Scientific, or your local agent.

Table of contents

1. Introduction	1
2. Precautions	1
3. Initial inspection	3
4. Overview	3
5. Specifications	4
5.1 Supported data rates and protocols	4
5.2 Electrical parameters	5
5.2.1 Current consumption	5
5.2.2 Voltage specifications	7
5.3 Environmental conditions	8
5.4 Physical Specifications	8
5.5 Data logger compatibility	8
6. Installation	9
6.1 Mounting	10
6.2 Connection and wiring	14
6.2.1 Power connections and current limits	20
6.2.1.1 Using one SDM-SIO2R in a system	21
6.2.1.2 Using two SDM-SIO2Rs in a system	21
6.2.1.3 Using three SDM-SIO2Rs in a system	22
6.2.1.4 Using three or more SDM-SIO2Rs in a system	22
6.2.2 Wiring examples for connecting the SDM-SIO2R	22
6.2.2.1 RS-485/RS-422 full-duplex, one-to-one connection example	23
6.2.2.2 RS-485 full-duplex, multi-drop example	23
6.2.2.3 RS-485 half-duplex wiring example	24
6.2.2.4 RS-232 wiring example with handshaking	24
6.2.2.5 RS-232 basic 3-wire example	25
6.2.2.6 Connecting a 9-way socket to the SDM-SIO2R for RS-232 devices	25
6.2.3 RS-232 and RS-485 with switched power example	26
6.3 Programming	26
6.3.1 CRBasic instructions	28

6.3.1.1 SerialOpen()	28
6.3.1.2 SerialClose()	31
6.3.1.3 SerialIn()	32
6.3.1.4 SerialOut()	32
6.3.1.5 SerialInBlock()	33
6.3.1.6 SerialOutBlock()	33
6.3.1.7 SerialInChk()	33
6.3.1.8 SerialInRecord()	33
6.3.1.9 SerialFlush()	33
7. Operation	33
7.1 Configuring handshaking and receive-only modes	33
7.1.1 Using RTS/CTS and automatic handshaking	34
7.1.2 RS-485 half-duplex mode	34
7.1.3 Using the RS-232 link in receive-only mode	35
7.2 Power conservation	35
7.3 Schematic	36
8. Troubleshooting and maintenance	37
8.1 Troubleshooting	37
8.2 Maintenance	38
8.2.1 Upgrading the operating system	38
8.2.2 Operating system signature errors	39
8.2.3 Checking the operating system version and signature	39
Appendix A. Using the handshaking lines for general input/output	41
A.1 Input pin (CTS)	41
A.2 Output pin (RTS)	42
Appendix B. Example data logger programs	44
B.1 Example using RS-232 mode	45
B.2 Example using RS-485 mode	46
B.3 Example using switched relay power	47
B.4 Example using SDM-SIO2R with CS120A	49

1. Introduction

The SDM-SIO2R Serial Input/Output Module is designed to allow expansion of the number of serial ports available on a data logger for communicating with intelligent sensors or driving external displays. It also has built-in power pass-through capabilities. Each SDM-SIO2R provides two separate communication channels and four different switched voltages.



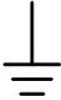

Figure 1-1. SDM-SIO2R

2. Precautions

READ AND UNDERSTAND the [Safety](#) section at the back of this manual.

- An authorized technician shall verify that the installation and use of this product is in accordance to the manufacturer's instructions, recommendations and intended use.
- Although the SDM-SIO2R is rugged, it should be handled as a precision scientific instrument.

- There are no user serviceable parts. Changes or modifications to this device not expressly approved by Campbell Scientific may result in damaged equipment or loss of data.
- The SDM-SIO2R has not been approved to be operated in hazardous locations as defined by the National Fire Protection Association (NFPA) 70®, National Electric Code® (NEC).
- WARNING: Ensure that the 12V power supply for the module is switched off when connecting the power and ground wires to the SDM-SIO2R. When making connections to a data logger, always ensure power to the data logger is switched off and connect the ground (G) wire first.
- WARNING: The RS-485 0V ground reference connection may be needed to ensure all units are referenced to a common ground voltage. This is more often needed with long cable runs. It is advisable to check the difference in ground potential with some caution before connecting any wires, to ensure the potential differences are reasonably small and excessive current will not flow between the two ground wires. There is a current limiting resistor fitted in the RG line in the SDM-SIO2R, but this will not be adequate in the event of a serious ground fault, for example, the ground references being 240 V apart due to faulty AC wiring. If a large potential difference is found, please seek the advice of a qualified electrician before continuing with the installation
- CAUTION: The power ground connection should be made with large gauge wire, (for example, 16 AWG or 1.5 mm²) to provide a low impedance path to ground allowing full protection from static and electrical transients.
- CAUTION: The SDM-SIO2R is considered to be a component of a measurement system that is installed in an enclosure and wired in accordance with this manual. Due to space considerations, full details of the maximum ratings of the connections are not given on the device. Instead the user should study this manual, and in particular [Voltage specifications](#) (p. 7), to determine the maximum voltages that are applicable to any terminal before starting an installation.

Symbol	Description
	Earth (ground) terminal, see Mounting (p. 10).
	Caution, see Installation (p. 9) and Safety .

3. Initial inspection

Upon receipt of the SDM-SIO2R, inspect the packaging and contents for damage. File damage claims with the shipping company. Contact Campbell Scientific to facilitate repair or replacement.

4. Overview

The SDM-SIO2R expands the number of serial ports on a Campbell Scientific data logger. It can be used as a means of collecting data from digital sensors and/or to send commands to sensors and devices. It can also be used to send data to remote display devices.

The SDM-SIO2R will accept serial data and store it in its buffer allowing remote equipment to transmit large amounts of data without needing to stop other processes in the data logger whilst the data is received.

The SDM-SIO2R connects to the data logger via three digital lines using a proprietary protocol called SDM. It connects to the remote serial device using a standard serial interface that can be set to RS-232, RS-485, or RS-422 signal levels.

Up to 8 SDM-SIO2Rs can be connected to a single data logger via the SDM port, allowing the user to connect 15 different items of equipment to their data logger with ease, in addition to any connections made to the data logger built-in serial ports. (Note that when using 8 SDM-SIO2Rs, only one-half of one of the SDM-SIO2Rs will be active. SDM allows for only 15 addresses, and each SDM-SIO2R requires two addresses. Any of the eight devices can be the one that is only partially active.) Only one SDM-SIO2R needs to be wired to power and SDM communications on the data logger. A din rail bus system is used to distribute the pass-through power and communication to the other devices.

The SDM-SIO2R can also be used in “talk-through” mode to allow a user to talk, via a terminal program, to a sensor connected to the SDM-SIO2R for test and diagnostic purposes. Please refer to the data logger manual for further details.

The SDM-SIO2R has four terminals that allow the user to control voltage on or off:

- Sensor 1: 12V
- Sensor 1: V+
- Sensor 2: 12V
- Sensor 2: V+

Voltage to these terminals is controlled through the CRBasic program. See [Programming](#) (p. 26)

NOTE:

The SDM-SIO2R is not a power supply. This device must be wired to a power supply that is capable of delivering the needed voltage and current. The SDM-SIO2R can be thought of as a pass-through switched voltage device for ease of wiring.

LEDs are used to indicate the presence of power at these terminals:

- If the LED is illuminated, there is voltage at the terminal and the sensor should be receiving power.
- If the LED is dark, there is no voltage at the indicated terminal.

NOTE:

For proper LED indication the 12V side of the SDM-SIO2R must be powered. If 12V is not powered, there may be voltage at V+ out even though the LED indicator is dark.

5. Specifications

5.1 Supported data rates and protocols

Data rates and protocols are set up using the [SerialOpen\(\)](#) instruction in CRBasic. The [SerialOpen\(\)](#) instruction is discussed in [SerialOpen\(\)](#) (p. 28).

Supported data rates: 300, 1200, 2400, 4800, 9600, 19200, 38400, 57600, and 115200 bits/s

Supported modes of operation:

RS-232 (full duplex and receive only)

RS-485 (half and full duplex)

RS-422 (full duplex)

Hardware CTS/RTS flow control is supported in RS-232 mode. The handshaking lines can also be used as general purpose I/O lines.

Supported data formats: 8, 7-bit data size*; none, odd or even parity; one or two stops bits

* In 7-bit mode with no parity, the user must ensure that the characters received by the SDM-SIO2R have a delay of at least one bit period between them. This does not affect any other configuration and does not affect transmissions out of the

SDM-SIO2R.

Miscellaneous information: The SDM-SIO2R does not support auto baud rate detection or use of the serial port for general PakBus® communications. Modbus and DNP3 communications are supported.

Buffer sizes

Transmit buffer size: 767 bytes (buffer from the data logger to the sensor)

Receive buffer size: 6143 bytes (buffer from the sensor to the data logger)

Both transmit and receive buffers are fill and discard type; that is, once the buffers become full, no new information is accepted and all further data is discarded until space is made when the data logger requests data from the SDM-SIO2R.

5.2 Electrical parameters



5.2.1 Current consumption

	Nominal	Max	Notes
General currents			
Standby current (12V & V+ ON)	13.22 mA	13.23 mA	Current after <code>SerialClose()</code> has been called
Standby current (12V & V+ OFF)	63.22 mA	64.71 mA	
V+ Output (Sensor 1 & 2)		5 A Total	
12V Output (Sensor 1 & 2)		5 A Total	
V+ Input		10 A	
12V Input		10 A	
Bus Connector, V+		6 A	
Bus Connector, 12V		6 A	

	Nominal	Max	Notes
RS-232 and RS-485 current consumption for both channels¹ (12V & V+ ON)			
Idle current	12.96 mA	12.96 mA	After <code>SerialOpen()</code> has been called
Idle current (receive only)	13.52 mA	14.84 mA	After <code>SerialOpen()</code> in receive-only mode
Active current (RS-232)	15.18 mA	16.26 mA	Active RS-232 command
Active current (RS-485)	15.63 mA	16.77 mA	Active RS-485 command (no termination resistors)
RS-232 and RS-485 current consumption for both channels¹ (12V & V+ OFF)			
Idle current	63.3 mA	63.8 mA	After <code>SerialOpen()</code> has been called
Idle current (receive only)	63.5 mA	65.5 mA	After <code>SerialOpen()</code> in receive-only mode
Active current (RS-232)	65.5 mA	67.4 mA	Active RS-232 command
Active current (RS-485)	65.9 mA	67.9 mA	Active RS-485 command (no termination resistors)
Line load currents			
RS-232 line load	2 mA per load	–	Average expected increase in drawn current per RS-232 line connected in idle or active modes (no extra current in standby mode). Both TX and RTS are considered to be RS-232 loads.

	Nominal	Max	Notes
RS-485 line load ²	40 mA ³	77 mA ⁴	This extra current is only present when actively transmitting
<p>¹ All currents are measured with no loads connected.</p> <p>² The RS-485 transmit pair is disabled when not transmitting in order to save power. Higher value resistors can be used to save power dependent upon the application. For many applications, especially with shorter cable runs, no load/termination resistors will be needed.</p> <p>³ Single 100 Ω load between transmit lines. Two 100 Ω resistors (one on each end) is the maximum recommended loading. Removing any termination resistance should dramatically decrease current consumption during transfer of data.</p> <p>⁴ The RS-485 interface is protected against short circuits via a 44 Ω resistance making this the maximum current possible even during short circuit. This resistance is part of the ESD protection circuitry and will be present at all times; it shouldn't affect normal circuit operations. Figure 7-1 (p. 36) shows the circuit in detail.</p>			

5.2.2 Voltage specifications

Connection	Minimum voltage ¹	Nominal voltage ¹	Maximum voltage ¹
Power supply, +12 V connection	9 V DC	12 V DC	30 V DC 
Pass through power, V+ connection	0 V DC or AC Resistive	N/A	30 V DC or AC Resistive 
RS-232 input threshold low	0.8 V	–	–
RS-232 input threshold high	–	–	2.4 V
RS-232 input absolute maximum ²	–	±15 V	±18 V
RS-232 input resistance	3 kΩ	5 kΩ	7 kΩ
RS-232 output voltage swing ³	±5 V	±5.4 V	–
RS-485 input (differential)	200 mV ⁴	–	6 V
RS-485 output (differential)	1.5 V (at 50 Ohms)	–	–

Connection	Minimum voltage ¹	Nominal voltage ¹	Maximum voltage ¹
SDM lines (high level)	4.5 V	5 V	5.5 V
SDM lines (low level)	0 V	–	0.7 V

¹ Voltage values are DC except for V+ which can handle AC or DC voltages.

² It is NOT recommended that the user run their SDM-SIO2R at maximum ratings for extended periods of time.

³ Assuming a worst case 3 kΩ load.

⁴ It is not recommended that the user allows such low input voltages as there will be an increased chance that external noise may cause errors in the incoming data.

5.3 Environmental conditions

The SDM-SIO2R can be operated safely under the following conditions.

Location: indoor use only, for wet environments use appropriate enclosure

Maximum elevation: 4,000 m (13,100 ft)

Temperature:

- Standard (ST): -40 to +70 °C

Relative humidity: 0-95% humidity, non-condensing

Pollution degree: 2 as defined by IEC 61010-1

5.4 Physical Specifications

Dimensions: 133.35 x 76.2 x 19.05 mm (5.25 x 3 x 0.75 in)

Weight: 108.5 g

Case Material Flammability rating V-0

5.5 Data logger compatibility

The SDM-SIO2R is compatible with our CR6-series, CR1000X, CR800-series, CR3000, and CR1000 data loggers.

6. Installation

The SDM-SIO2R is an addressable interface; therefore, before use, its SDM address needs to be set by rotating the Address switch using a screwdriver. If there is only one SDM device, the address can be left at the default of **0**. (Refer to [Mounting](#) [p. 10] if there is more than one SDM device.) After mounting as close to the data logger as possible (to minimize the cable runs), the interface is connected to the data logger SDM and power connections. Refer to [Connection and wiring](#) (p. 14) for further details.

Study the documentation of the serial device you want to connect to the SDM-SIO2R to determine the most appropriate method of connection for the application, for example, RS-232 or RS-485/RS-422, half or full duplex. Generally, RS-485/RS-422 connections are used for cable runs over 50 m (164 ft) if the device supports them. Once decided, connect the wires to the relevant SDM-SIO2R terminals. Make sure a connection is made between the ground connections of the two devices. Use the **RG** terminal on the SDM-SIO2R for RS-485/422 connections.

Some serial sensors are supported by the Campbell Scientific *Short Cut* program. The SDM-SIO2R can be used with those programs simply by selecting the relevant serial port number to match the SDM-SIO2R (defined by the SDM address of the SDM-SIO2R, see [Mounting](#) [p. 10]). Care must be taken when interpreting any wiring instructions generated by *Short Cut* to account for the differences in wiring a sensor to the SDM-SIO2R rather than directly to the data logger.

For other sensors or more complex applications, a CRBasic program needs to be written to configure and enable the connection between the two devices.

To write a program, it is first necessary to determine how data will be exchanged. When using the SDM-SIO2R to collect data from a sensor, there are two options. The data logger requests data and then picks up the data in the response from the sensor (often called polling) or the sensor transmits data “one-way” to the data logger at fixed intervals based upon its internal timer. The latter mode is more common but can lead to problems with synchronizing the sensor measurements with other measurements the data logger is making and can also lead to the occasional missed data value if the sensor clock is running slightly slower than the data logger clock.

The SDM-SIO2R is implemented in such a way that it looks like a built-in serial port to the user when writing programs in CRBasic. The only difference in operation between the SDM-SIO2R and a built-in port is that there will be a small delay as the data needs to be transferred from the SDM-SIO2R to the data logger via the SDM port. That delay is usually only significant if large amounts of data are being read or the data logger program needs to run very fast.

For sending and receiving data, the [SerialOpen\(\)](#) instruction is used to specify which serial port, the speed, and mode of operation. The speed is set by the **BaudRate** parameter in the instruction and the mode (bits, parity, duplex, RS-232 or RS-485) is set by the **SerialOpenFormat** parameter. Refer to the *CRBasic Editor* help system for more details of the options. With the correct parameters in the [SerialOpen\(\)](#) instruction, the program can be written in almost exactly the same way as using any other serial port with [SerialIn\(\)](#), [SerialOut\(\)](#), and similar instructions. The [Programming](#) (p. 26) section of this manual gives details of some of the minor changes needed and some simple program examples.

The SDM-SIO2R can also be used as an interface to Modbus and DNP3 sensors or networks. The interface is configured by including an extra [SerialOpen\(\)](#) instruction at the start of the program. Normal calls to the relevant Modbus or DNP3 instructions can then be used specifying the COM port number relevant to the SDM-SIO2R.

6.1 Mounting

The SDM-SIO2R is designed to be installed in a dry, non-condensing environment. The SDM-SIO2R is normally mounted on a DIN rail mounting bracket (as shown in [DIN rail mounting](#) (p. 10)) that is then attached to the backplate of a Campbell Scientific enclosure.

WARNING:

CSI pn 39979 is the only DIN rail connector and bus that can be used. The warranty will be voided if a non-specified connector is used.

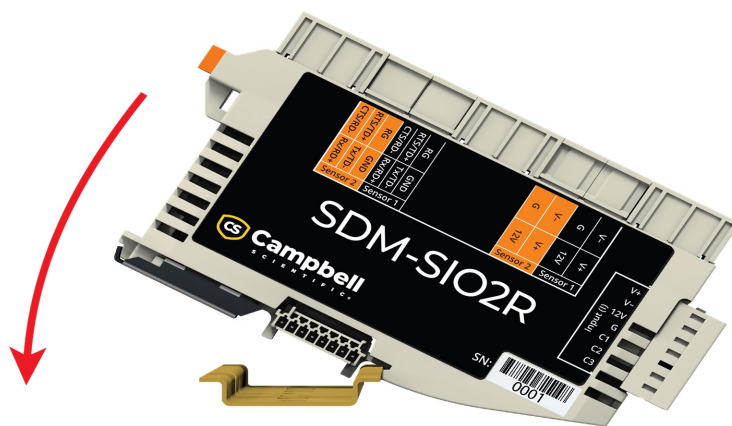

Figure 6-1. DIN rail mounting

NOTE:

Ground path is through DIN rail clip. Ensure DIN rail is properly grounded.

A SDM-SIO2R can be removed from the DIN rail by using a screwdriver to pry on the din rail release bar. See [DIN rail release bar](#) (p. 11).

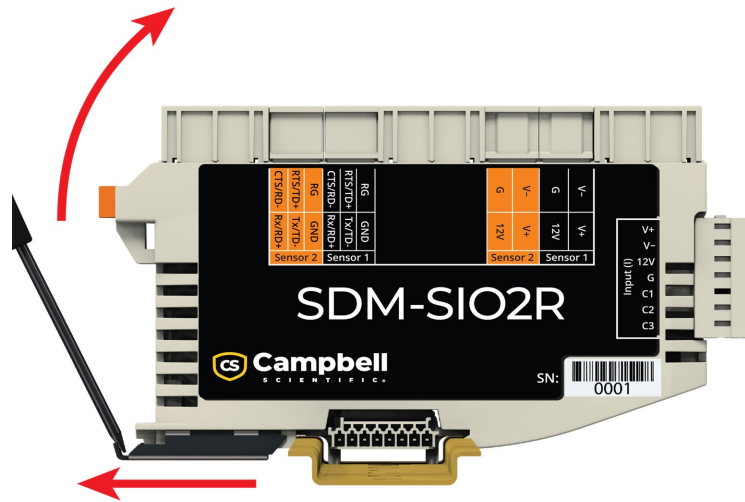

Figure 6-2. DIN rail release bar

All SDM-SIO2Rs that are connected on the DIN rail will share a common bus.

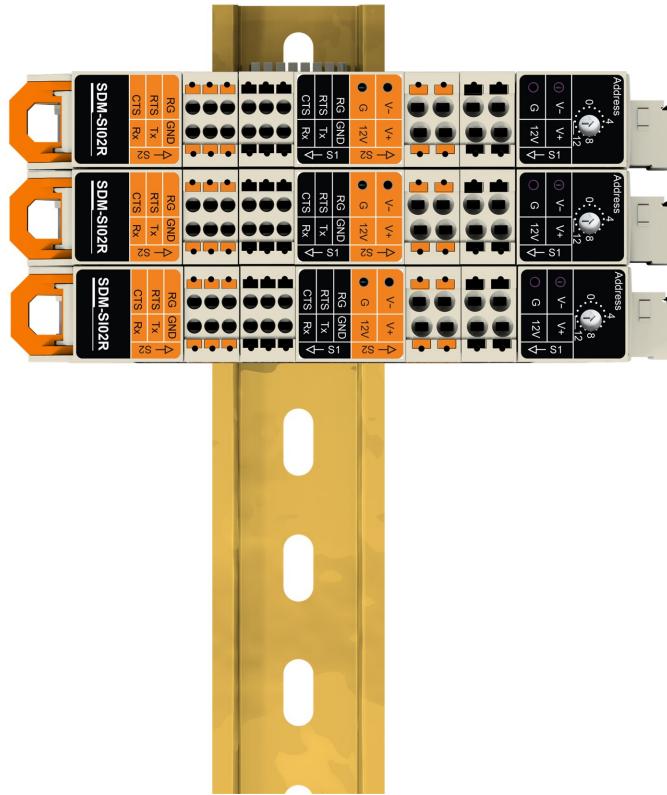

Figure 6-3. Multiple SDM-SIO2Rs sharing a common bus

Keep SDM-SIO2Rs apart to maintain separate buses.

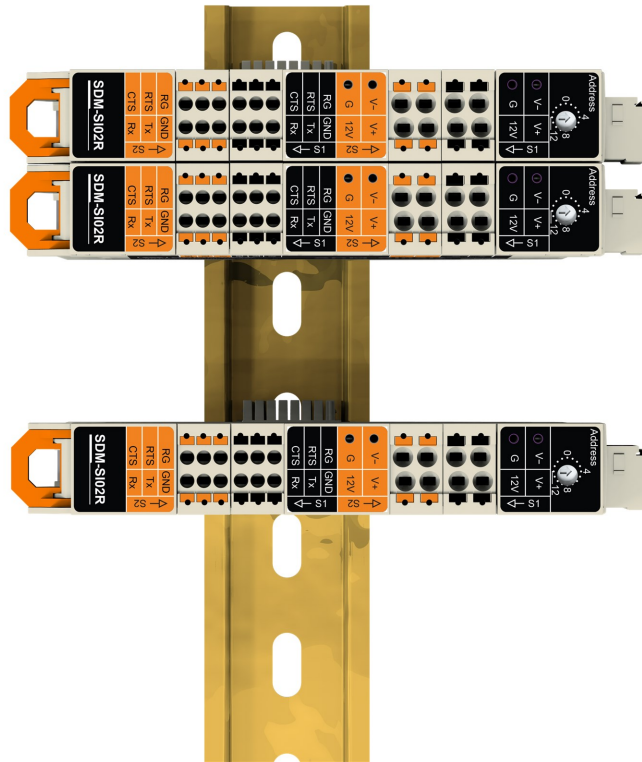

Figure 6-4. Multiple SDM-SIO2Rs with separate buses

Before mounting, select and set the SDM address. The SDM address is set with a screwdriver. [Table 6-1](#) (p. 14) lists the possible SDM addresses and their relationships to the **COMPort** parameter in the [SerialOpen\(\)](#) instruction.

There can be up to 8 SDM-SIO2Rs on a single SDM bus. Each SDM-SIO2R will need to be set to a unique address before they are powered. The SDM-SIO2R has a single address switch. This sets the address of the first serial port of the module (sensor 1). The SDM address of the second serial port will follow sequentially from the port 1 address. For example, if the address switch is set to 4, sensor 1 has SDM address 4 and sensor 2 has SDM address 5. Since each SDM-SIO2R on the bus takes up two SDM addresses, their address switches must be set with at least one address in between. If an address switch is set to “E” (SDM 14), only the first port of the SDM-SIO2R is enabled. If any other equipment is present on the bus, whether an SDM-SIO2R or other SDM device, the user will have to ensure their addresses are unique.

NOTE:

If the address switch is changed, the SDM-SIO2R must be power cycled for the new address to take effect.

Rotary switch position	SDM address	SerialOpen() instruction COMPort number
0	0	32
1	1	33
2	2	34
3	3	35
4	4	36
5	5	37
6	6	38
7	7	39
8	8	40
9	9	41
10	10	42
11	11	43
12	12	44
13	13	45
14	14	46
15 ¹	15 ¹	47 ¹

¹ Address F is not available as it is the broadcast address. Setting this address will result in the SDM-SIO2R having an address of 0 rather than F.

6.2 Connection and wiring

SDM-SIO2R connections to the data logger are made via the Input connector. Strip wires 7 to 9 mm and twist. Open the clamp by inserting a small screwdriver into the small hole and prying away from the clamp. Insert the wire. Release the clamp and verify the clamp grips the wire rather than the plastic insulation. See [Input connections](#) (p. 15).

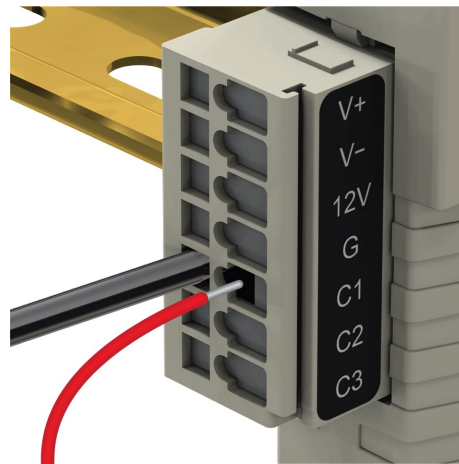

Figure 6-5. Input connections

SDM-SIO2R connections to serial devices are made via the terminals arranged along the top of the unit. The terminals are spring loaded providing an easy and reliable method of connection. Strip wires 7 to 9 mm and twist. Open the clamp by pushing the orange tab down with the tip of a small flat-blade screwdriver and insert the wire into the round hole. Release the clamp and verify the clamp grips the wire rather than the plastic insulation. See [Serial and switched power connections](#) (p. 15)

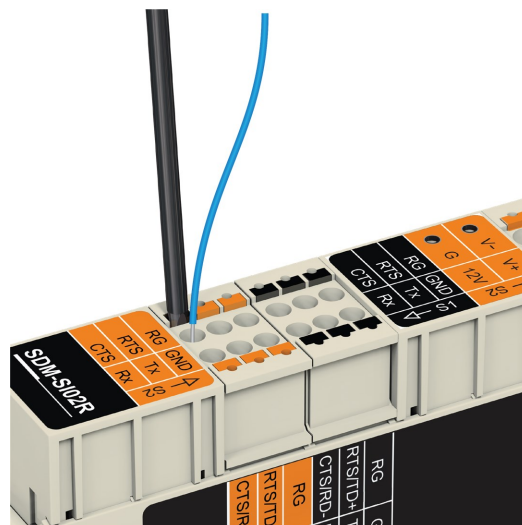

Figure 6-6. Serial and switched power connections

If there is a need to insert more than one wire in each terminal, if using multi-strand wire, twist the conductors together first. If using solid wires, solder or crimp multiple pairs together before insertion.

Ferrules can be used for connections.

NOTE:

- The SDM-SIO2R Input connector can handle wire sizes ranging from 14-28 AWG.
- The SDM-SIO2R6- Pin and 4-pin sensor communication connectors can handle wire sizes ranging from 16-24 AWG.
 - When using 20-24 AWG ferrules on the SDM-SIO2R 6-pin communication connectors, longer ferrules must be used (for example, Campbell Scientific pn 40233).

If necessary, a connector can be removed from the device by unlocking the slide bar. See [Connector release slide bar](#) (p. 16).

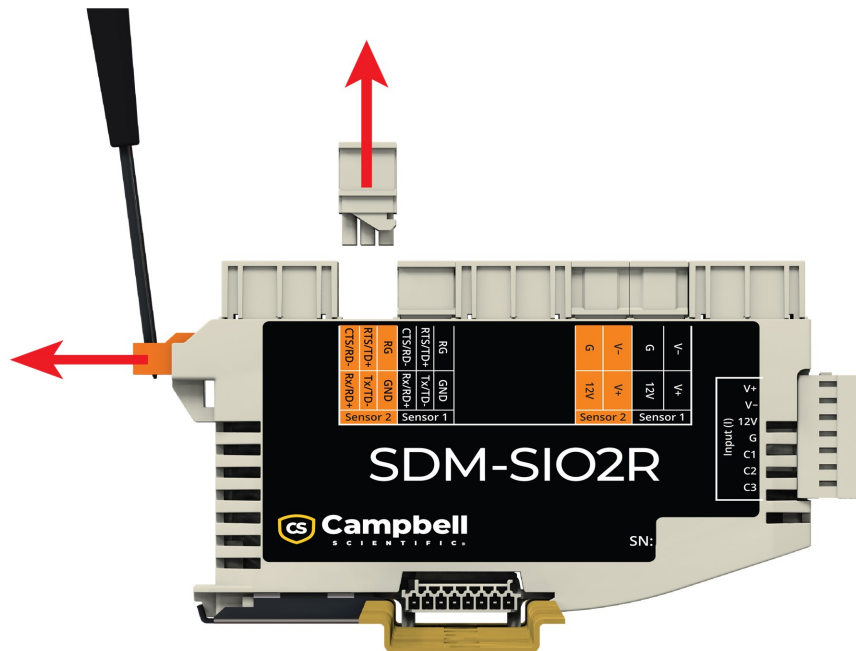

Figure 6-7. Connector release slide bar

NOTE:

The 12V power ground for the SDM-SIO2R must be common ground with the data logger in order for the C1/C2/C3 communications to work.

NOTE:

The sensor with the highest current draw should be connected to the SDM-SIO2R that is plugged into power and communications on the Input connector. It is recommended that this is the center SDM-SIO2R in the system.

Table 6-2 (p. 17) shows all the input connections on the SDM-SIO2R.

Table 6-2: SDM-SIO2R input terminal labels and functions						
Power				SDM		
V ₊	V ₋	12V	G	C1	C2	C3
1	2	3	4	5	6	7

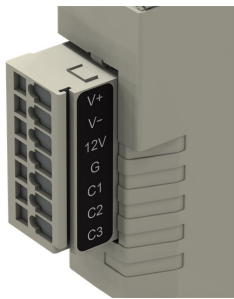

Table 6-3 (p. 17) shows all the serial communication connections on the SDM-SIO2R. Note that there are two communication connectors. One for Sensor 1 and one for Sensor 2.

Table 6-3: SDM-SIO2R communication terminal labels and functions					
Communication					
RG	GND	RTS	Tx	CTS	Rx
1	2	3	4	5	6



Table 6-4 (p. 18) shows all the power pass-through connections on the SDM-SIO2R. Note that there are two power pass-through connectors. One for Sensor 1 and one for Sensor 2.

Table 6-4: SDM-SIO2R power pass-through terminal labels and functions			
Power pass-through			
V-	V+	G	12V
1	2	3	4



Table 6-5: SDM-SIO2R functional description of input connections			
Pin	Case text	Connection to	Description
1	V+	Power supplies	Power supply 0-30V AC or DC
2	V-		Power supply return 0-30V AC or DC
3	12V		Power supply 9-30 V DC (powers internal electronics and LEDs)
4	G		Power supply ground
5	C1	Data logger	SDM_Data
6	C2		SDM_Clock
7	C3		SDM_DataEnable

Table 6-6: SDM-SIO2R functional description of sensor connections

Pin	Case text (RS-232 Function)	RS-485 Function	Connection to	Description
1	RG ¹		Sensors Note that all of the sensor connections are repeated on two connectors: Sensor 1 and Sensor 2	RG – RS-485 ground. Connected to G via 100 Ω 1 W resistor.
2	GND ²			GND - ground for RS-232 communications
3	RTS	TD+		RS-232 RTS. RS-485 half duplex non-inverting. RS-485 full duplex outgoing.
4	Tx	TD-		RS-232 transmit. RS-485 half duplex inverting. RS-485 full duplex outgoing.
5	Rx	RD+		RS-232 receive. RS-485 receiver non-inverting. RS-485 full duplex incoming.
6	CTS	RD-		RS-232 CTS. RS-485 receiver inverting. RS-485 full duplex incoming.
1	V-			AC or DC voltage source return from power supply
2	V+			AC or DC voltage source from power supply

Table 6-6: SDM-SIO2R functional description of sensor connections

Pin	Case text (RS-232 Function)	RS-485 Function	Connection to	Description
3	G			DC ground from power supply
4	12V			DC voltage source from power supply

¹ Connection RG has a 100 Ω resistor in series with the data logger ground connection. This connection should be used when connecting RS-485 equipment by long wire lengths. It ensures both systems have a common ground reference point. See [Precautions](#) (p. 1) before connecting.

² The **GND** can be used for the RS-232 zero volt reference or any other ground connection needed, for example, shields.

The connection of the wires to the remote serial device or sensor will vary with type of device and method of communication. It is necessary to work out the best mode of operation of the serial device, taking into consideration issues such as power consumption, cable lengths (RS-485 being better than RS-232 for long cables), synchronization of data collection, etc.

NOTE:

If possible, use screened cable for connecting the SDM-SIO2R to remote sensors or devices. Check the manual of the device for details on where to connect the screen for maximum effectiveness.

RS-422 mode is functionally the same as RS-485 mode except the connection is limited to a point-to-point system. Connections and programming for

RS-422 are otherwise identical to full-duplex RS-485.

When operating in RS-232 mode, the SDM-SIO2R also supports hardware handshaking.

[Wiring examples for connecting the SDM-SIO2R](#) (p. 22) provides examples of different connection schemes for the serial devices. Further discussion of different modes of operation is given in [Operation](#) (p. 33).

6.2.1 Power connections and current limits

SDM-SIO2R power connections and current limits are shown in the following subsections.

6.2.1.1 Using one SDM-SIO2R in a system

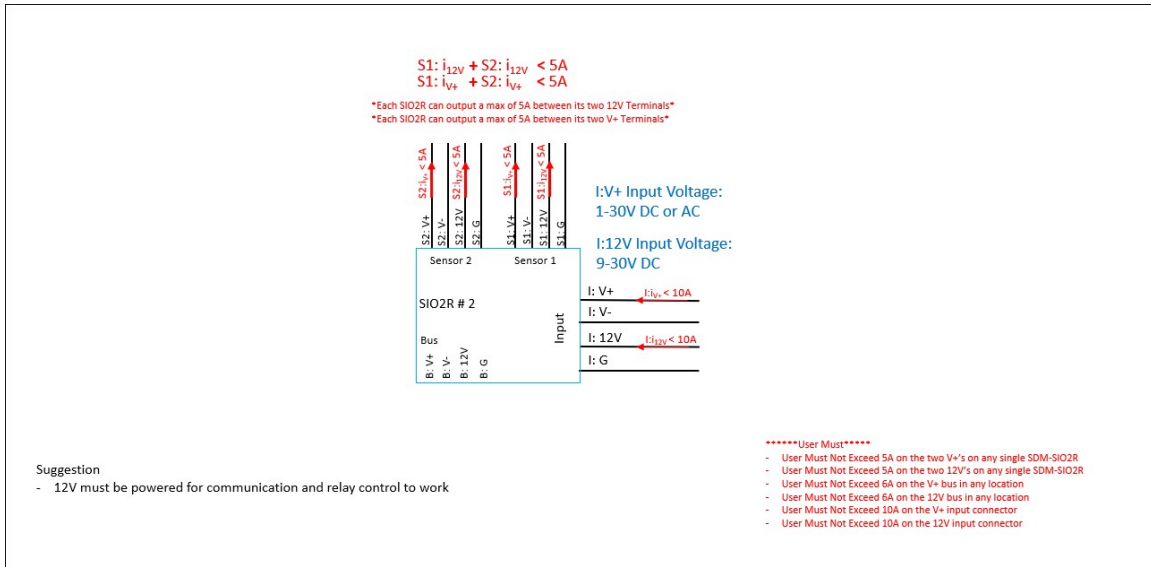

6.2.1.2 Using two SDM-SIO2Rs in a system

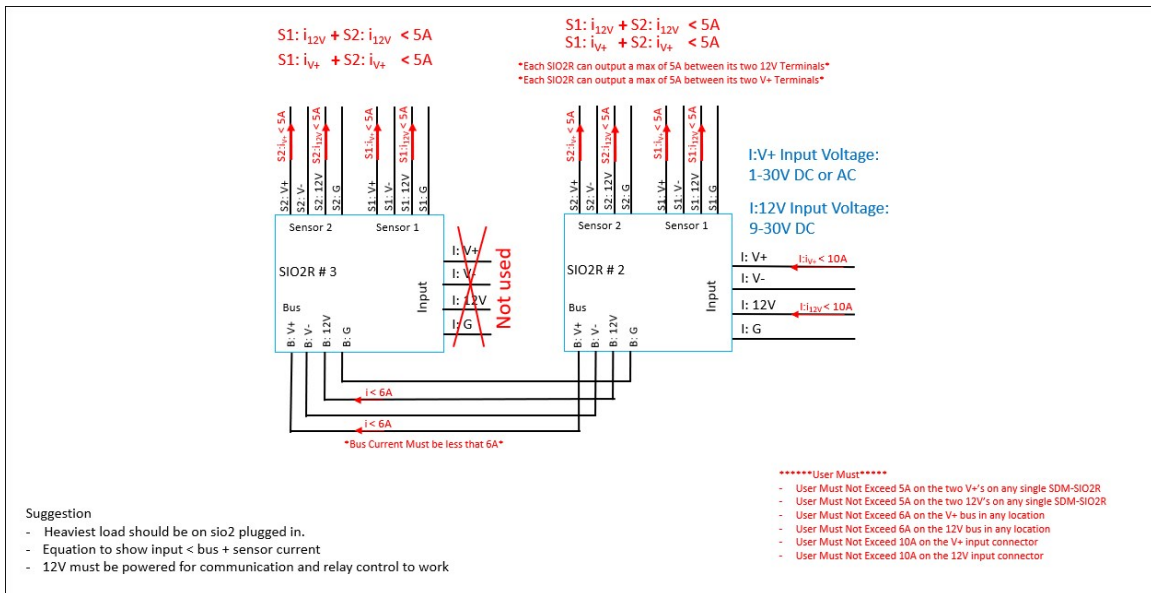

6.2.1.3 Using three SDM-SIO2Rs in a system

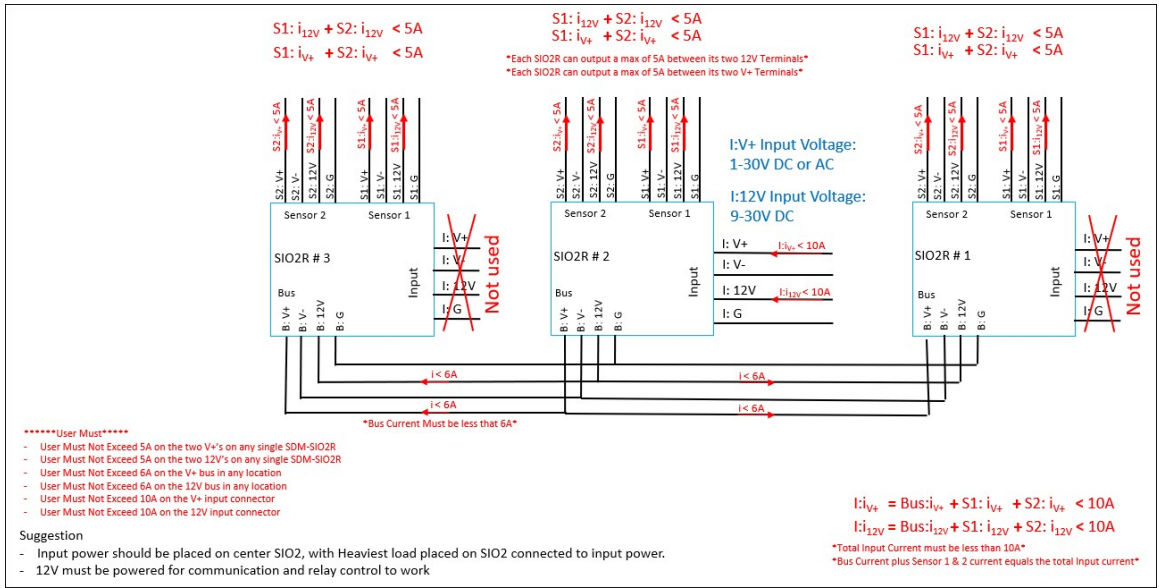

6.2.1.4 Using three or more SDM-SIO2Rs in a system

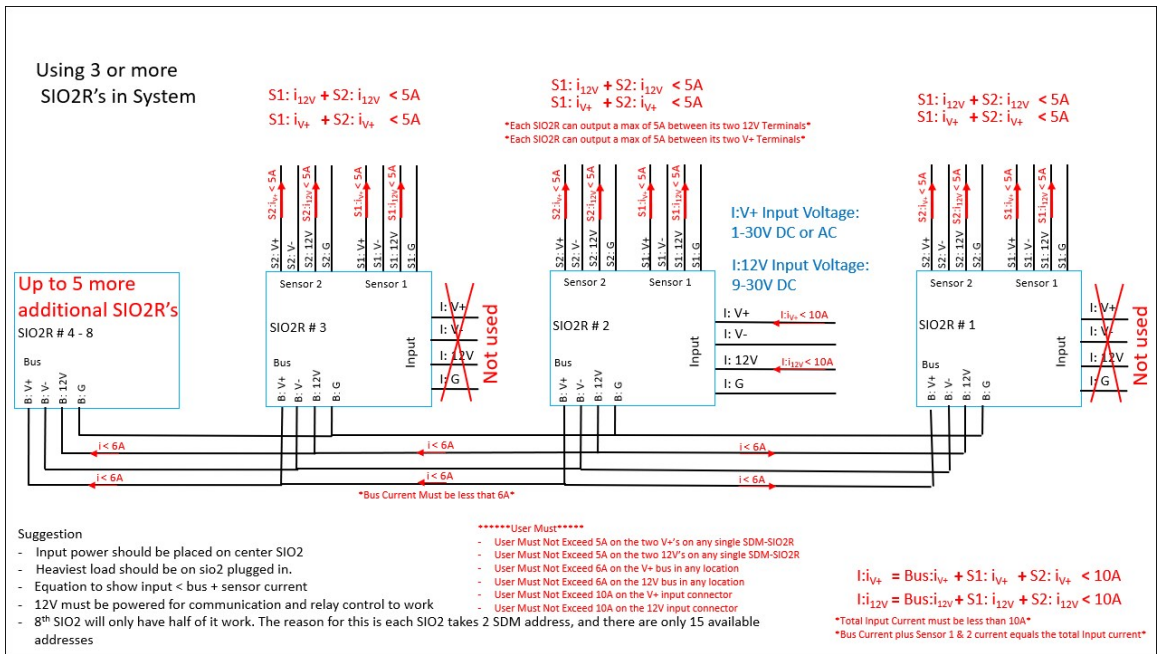

6.2.2 Wiring examples for connecting the SDM-SIO2R

The exact method of wiring the SDM-SIO2R varies with the type of device it is going to exchange data with. The variables include the type of interface used (RS-232, RS-485, or RS-422), whether

handshaking is used, whether the connection is full or half duplex, and whether termination resistors are used (RS-485 and RS-422 only).

Typical wiring for the most common configurations are given as examples in the following subsections.

6.2.2.1 RS-485/RS-422 full-duplex, one-to-one connection example

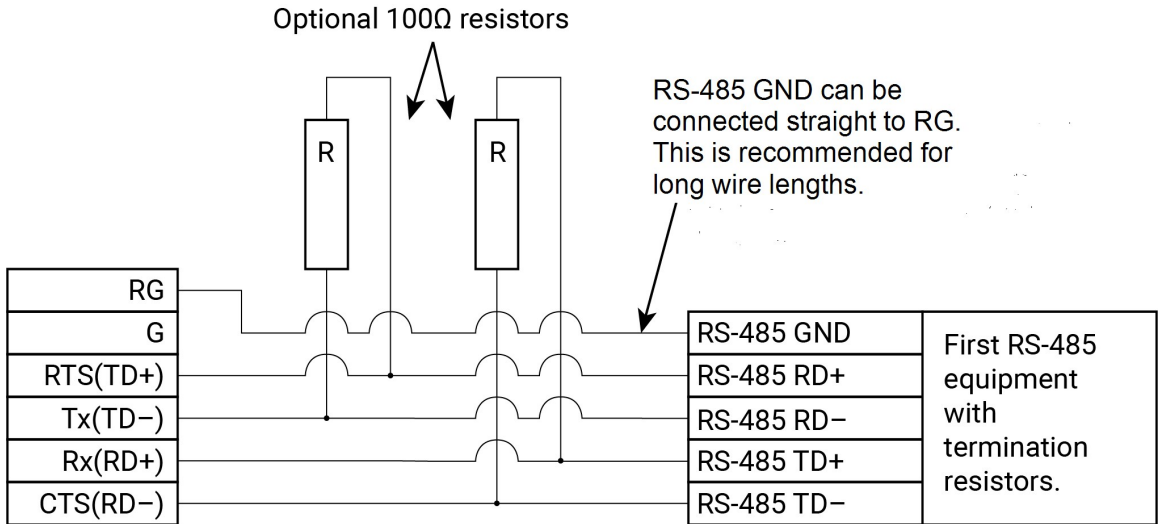

6.2.2.2 RS-485 full-duplex, multi-drop example

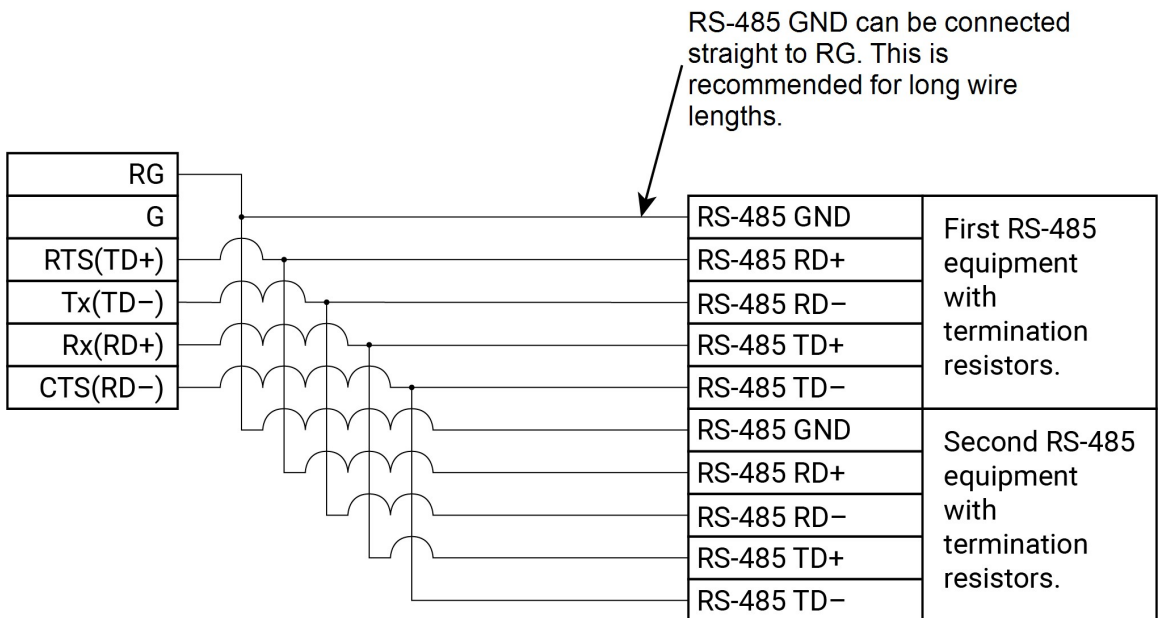

6.2.2.5 RS-232 basic 3-wire example

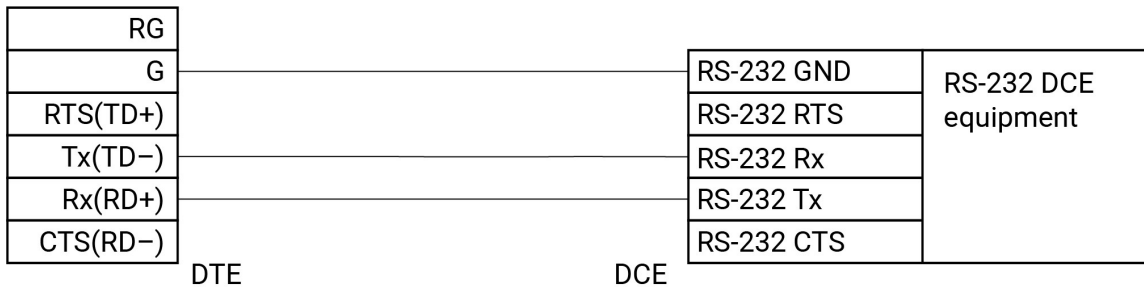

6.2.2.6 Connecting a 9-way socket to the SDM-SIO2R for RS-232 devices

This configuration may be used if the device is fitted with a standard 9-way D connector as was commonly fitted to computers for their RS-232 port. You need to check whether the device is configured as a DTE or DCE device and whether it has a male or female connector before making up this cable.

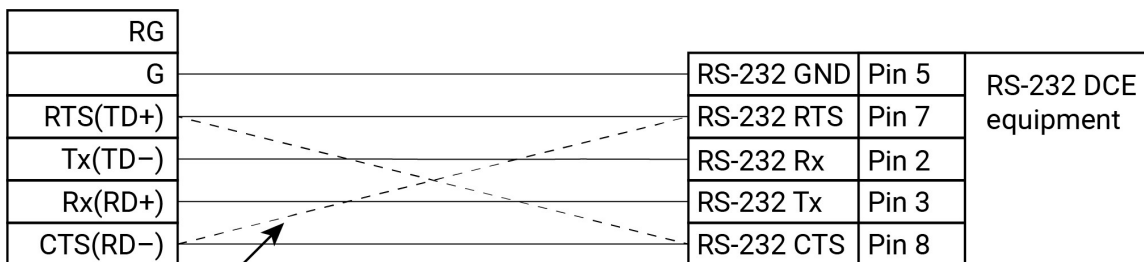

Note 2.

- 1) This diagram is for adding a 9-way d-type plug to the SDM module. A standard one-to-one serial lead (note 2) can then be used to connect to another piece of equipment (for example, a computer or sensor).
- 2) Since there is no standard that indicates whether certain devices should be DTE or DCE, it may be necessary to reverse the CTS(RD-) and RTS(TD+) pins when wiring hardware handshaking. Cross the wires either by crossing them manually (as shown by the dotted lines), or by purchasing a special cable for this purpose.

- In RS-232 mode, the main use of the CTS/RD- and RTS/TD+ lines is as RTS/CTS hardware handshaking lines. CTS/RD- should be connected to the remote equipment RTS, and RTS/TD+ to its CTS line.

- The CTS/RD– (CTS) and RTS/TD+ (RTS) lines can also be used to trigger external circuitry when not being used in handshaking mode. Note that when using CTS/RD– and RT/TD+ lines as input and output, the voltage levels are $\pm 5V$, NOT 0 and 5V.
- CTS/RD– and RTS/TD+ cannot be used as separate input and output when in RS-485 mode.

6.2.3 RS-232 and RS-485 with switched power example

This image shows an example system with one RS-232 sensor and one RS-485 sensor, both using switched power.



6.3 Programming

The [SDMGeneric\(\)](#) is used to turn the 12V and V+ terminals on and off.

NOTE:

Use [SequentialMode](#) if the [SDMGeneric\(\)](#) instructions need to be inside a conditional statement.

[SDMGeneric](#)(Dest, SDM_addr, 7, 1, hexVar, 0, 1, 1, -0

Dest is a variable declared to hold any incoming bytes from the SDM device. **SDM_addr** is the SDM address of the device. **HexVar** is a 2-digit hex value that determines if a voltage is turned on or off. The left digit controls V+; the right digit controls 12V. Sending a 1 for a digit turns the Relay and LED on; sending a 2 for a digit turns the relay and LED off; sending a 0 will not change the relay/LED value. For example:

- hexVar0 = &H01: V+ unchanged, 12V ON
- hexVar0 = &H10: V+ ON, 12V unchanged
- hexVar0 = &H11 : V+ ON, 12V ON
- hexVar0 = &H22: V+ OFF, 12V OFF

See [Example using switched relay power](#) (p. 47) for an example of how to write programs in CRBasic to turn the switched relay power on and off.

The normal serial port instructions such as [SerialOpen\(\)](#) and [SerialIn\(\)](#) are used with the SDM-SIO2R to send and receive data. Aside from changes to the **COMPort** and the **SerialOpenFormat** parameter, a program written for a standard serial port will usually work with the SDM-SIO2R. The main difference to be aware of, when trying to write fast running programs, is the extra delay needed to transfer data from the SDM-SIO2R to the data logger (roughly equivalent to transferring data over a serial link at 38 kilobaud).

The following section gives further information about the CRBasic programming language and how the serial instructions are to be used with the SDM-SIO2R.

This section assumes the user has knowledge of the CRBasic programming language. A useful introduction to programming for serial sensors can be found here:

<https://s.campbellsci.com/documents/sp/technical-papers/serial.pdf> 

See [Example data logger programs](#) (p. 44) for two simple example CRBasic programs that send and receive data using the SDM-SIO2R.

Please contact Campbell Scientific for further assistance or training. The Campbell Scientific user forum is also a useful resource to check if others might have already written code for a specific serial device.

Only the parameters that need special explanation or whose functionality has changed when used with the SDM-SIO2R are listed in the following sections. Any other parameters should be

taken as not having changed. Please refer to the data logger manual and/or the *CRBasic Editor* help system for more guidance.

6.3.1 CRBasic instructions

6.3.1.1 SerialOpen()

All internal buffers in the SDM-SIO2R will be flushed when this instruction is called, resulting in the loss of any data that might have been in them at that point in time.

- **COMPort**

The **COMPort** numbers are defined in [Table 6-1](#) (p. 14). COM port numbers in the range of 32 to 47 are reserved for use with the SDM-SIO2R.

- **BaudRate**

BaudRate is used to set up the SDM-SIO2R baud rate as you would with any RS-232 interface. The SDM-SIO2R does not support automatic baud rate recognition. Instead, setting the rate to a negative number sets the automatic flow control system (RTS/CTS). This system is discussed in greater detail in [Using RTS/CTS and automatic handshaking](#) (p. 34).

- **SerialOpenFormat**

This parameter sets the data format. It also determines whether the SDM-SIO2R works in normal RS-232, listen-only RS-232, full-duplex RS-485, or half-duplex RS-485 mode as defined in the following tables.

SerialOpenFormat	Parity	No. stop bits	No. data bits
0	None	1	8
1	Odd	1	8
2	Even	1	8
3 (default)	None	1	8
4	Not used		
5	Odd	2	8
6	Even	2	8

Table 6-7: Communications port parameters RS-232

SerialOpenFormat	Parity	No. stop bits	No. data bits
7	None	2	8
8	Not used		
9	Odd	1	7
10	Even	1	7
11 ¹	None	1	7
12	Not used		
13	Odd	2	7
14	Even	2	7
15	None	2	7

¹ This mode is only supported if there is at least a one-bit delay between characters received by the SDM-SIO2R.

Table 6-8: Communications port parameters RS-485 full duplex

SerialOpenFormat	Parity	No. stop bits	No. data bits
16	None	1	8
17	Odd	1	8
18	Even	1	8
19	None	1	8
20	Not used		
21	Odd	2	8
22	Even	2	8
23	None	2	8
24	Not used		
25	Odd	1	7
26	Even	1	7
27 ¹	None	1	7
28	Not used		
29	Odd	2	7

Table 6-8: Communications port parameters RS-485 full duplex

SerialOpenFormat	Parity	No. stop bits	No. data bits
30	Even	2	7
31	None	2	7

¹ This mode is only supported if there is at least a one-bit delay between characters received by the SDM-SIO2R.

Table 6-9: Communications port parameters RS-485 half duplex

SerialOpenFormat	Parity	No. stop bits	No. data bits
48	None	1	8
49	Odd	1	8
50	Even	1	8
51	None	1	8
52	Not used		
53	Odd	2	8
54	Even	2	8
55	None	2	8
56	Not used		
57	Odd	1	7
58	Even	1	7
59 ¹	None	1	7
60	Not used		
61	Odd	2	7
62	Even	2	7
63	None	2	7

¹ This mode is only supported if there is at least a one-bit delay between characters received by the SDM-SIO2R.

Table 6-10: Communications port parameters RS-232 receive-only mode

SerialOpenFormat	Parity	No. stop bits	No. data bits
64	None	1	8
65	Odd	1	8
66	Even	1	8
67	None	1	8
68	Not used		
69	Odd	2	8
70	Even	2	8
71	None	2	8
72	Not used		
73	Odd	1	7
74	Even	1	7
75 ¹	None	1	7
76	Not used		
77	Odd	2	7
78	Even	2	7
79	None	2	7

¹ This mode is only supported if there is at least a one-bit delay between characters received by the SDM-SIO2R.

6.3.1.2 SerialClose()

This will place the SDM-SIO2R unit into shutdown mode where only SDM communications will operate. This means any data coming into the SDM-SIO2R on the RS-232/RS-485 interface will be lost.

This is the lowest possible power mode, and for optimum power efficiency, the SDM-SIO2R should be placed in this mode whenever possible.

6.3.1.3 SerialIn()

The primary difference when using this instruction with an SDM-SIO2R compared to when it is used with a serial port built into the data logger is timing. If the data has already been sent by the remote sensor/system, the instruction will run in a few tens of microseconds as the data is read from internal memory. However, when using the SDM-SIO2R, extra time is required to transfer data from the module into the data logger memory.

The extra time (in microseconds) taken to transfer data from the SDM-SIO2R to the data logger can be calculated using the following formula:

$$\text{Time} = (C + 1) \times (8 \times \text{SDMRate})$$

Where,

C = Number of characters to transfer from the SDM-SIO2R

SDMRate = Rate set using the [SDMSpeed\(\)](#) instruction in CRBasic giving the time in microseconds for one bit period.

It's worth noting that the bit rate defined by [SDMSpeed\(\)](#) is not exact and will vary slightly depending on the data logger used. If you require more accurate information about SDM data rates, consult your data logger documentation.

Example

The instruction [SerialIn\(Dest, 32, 1, 0, 10\)](#) using a 30 μ s bit rate would transfer its 10 bytes of data from the SDM-SIO2R to the data logger in approximately 2.7 ms.

$$\text{Time (in microseconds)} = (10 + 1) \times (8 \times 30)$$

Note that 30 μ s per bit is the default data rate for most Campbell Scientific data loggers. It is possible to reduce this time and the transfer time by using the [SDMSpeed\(\)](#) instruction. This can be done if using short cable runs between the data logger and all SDM devices.

6.3.1.4 SerialOut()

Transmission from the SDM-SIO2R will commence once the first byte of user information is received from the data logger. There will be a total delay of 16 bit periods (at the [SDMSpeed\(\)](#)) before transmission commences. Normally this delay can be ignored as it is short (0.48 ms), but some applications may need to account for it.

6.3.1.5 SerialInBlock()

The `SerialInBlock()` instruction can be used as described in the data logger manual. However, if using the option to capture only the most recent data, make sure the instruction is called often enough to avoid filling up the SDM-SIO2R buffer. The SDM-SIO2R buffer operates in fill and stop mode, and, therefore, will not include the most recent data if it gets full.

6.3.1.6 SerialOutBlock()

No special information. Can also be used to set the general purpose output line. See [Using the handshaking lines for general input/output](#) (p. 41) for more information.

6.3.1.7 SerialInChk()

This returns the number of characters that have been received by the SDM-SIO2R and that are currently held in its buffer (0-6143).

6.3.1.8 SerialInRecord()

No special information.

6.3.1.9 SerialFlush()

This instruction will purge all information in the data logger and SDM-SIO2R transmit and receive buffers.

7. Operation

This section includes more detail on less common modes of operation, provides details on how to save power use, and shows the internal configuration of the SDM-SIO2R when configured in RS-485 or RS-422 full-duplex mode.

7.1 Configuring handshaking and receive-only modes

7.1.1 Using RTS/CTS and automatic handshaking

Handshaking is a method used by RS-232 to ensure communications equipment is free to receive or transmit data. This interface is often called RTS/CTS (hardware handshaking) or DTR/DTE.

Automatic handshaking for the SDM-SIO2R is activated through use of the **BaudRate** parameter of the [SerialOpen\(\)](#) instruction.. When the **BaudRate** value is set to a negative number, the SDM-SIO2R will enable automatic handshaking. It is worth noting that normally setting the **BaudRate** to a negative number will enable automatic baud rate detection; this is not the case for the SDM-SIO2R.

When enabled, the two I/O ports will operate as RTS and CTS lines. It is important that the remote equipment supports handshaking as no data will be sent if handshaking is enabled but is not supported by the equipment the SDM-SIO2R is connected to.

Once handshaking is enabled, these pins are no longer available for general use and are dedicated to the auto-handshaking system.

Enabling handshaking will increase active current consumption due to the extra RS-232 load. It will not affect sleep current, however, as the RS-232 chip is disabled (sleep is set by calling the [SerialClose\(\)](#) function).

For connection diagrams and further information on using handshaking, consult [Wiring examples for connecting the SDM-SIO2R](#) (p. 22).

NOTE:

- Auto flow control should only be selected in RS-232 mode.
- When Auto flow control is enabled, the user cannot set or clear the spare I/O ports.

7.1.2 RS-485 half-duplex mode

In RS-485 half-duplex mode, the SDM-SIO2R will wait for approximately 2.5 ms after a character is received before it tries to transmit any data in its transmit buffer. This is to ensure that a contention does not occur on the data line which will cause data corruption. There is also a delay of at least the time to send one character after the last character has been transmitted before the SDM-SIO2R will listen for new incoming data.

NOTE:

When in either RS-485 half-duplex or full-duplex modes, the user cannot set or clear the spare I/O ports (pins 8 and 11).

7.1.3 Using the RS-232 link in receive-only mode

To place the SDM-SIO2R into RS-232 receive-only mode, use the `SerialOpen()` instruction with the `SerialOpenFormat` value set within the range of 64 to 79. Consult [SerialOpen\(\)](#) (p. 28) for more detailed information about these settings.

In receive-only mode, the SDM-SIO2R will consume less current than normal but still can receive new information on its RS-232 port.

The following example will set the SDM-SIO2R with address 0 into receive-only mode. All normal baud rates and buffer sizes are supported.

Example

```
SerialOpen (32,115200,64,100,10000) 'Set receive only mode
```

7.2 Power conservation

The SDM-SIO2R features an industry-standard RS-232/RS-485 driver chipset to ensure maximum likelihood of compatibility with all other devices. When the driver is powered on, it uses more power than one of the data logger control-port-based COM ports — typically 6 mA minimum. This is partly because it generates the correct signal levels, which in itself requires power, and partly because, in the case of RS-232 signals, the resting state of ~ -6 V driving a nominal RS-232 ~ 3 k load implicitly wastes ~ 2 mA of current per line.

To avoid excess current waste, the chip can be turned off when not in use, for example, between polled measurements, simply by closing the serial port, using `SerialClose()` (see [SerialClose\(\)](#) [p. 31]). When running in RS-232 mode with a sensor that only sends data one way to the data logger, run the SDM-SIO2R in “receive-only mode” as this does not turn on the output drivers (see [Using the RS-232 link in receive-only mode](#) [p. 35]).

If using RS-232 mode, also avoid connecting handshaking lines that are not required to avoid an unnecessary 2 mA drain per line.

The SDM-SIO2R will start up with its last set of baud rate and protocol settings. This feature is to protect against brownout conditions where the SDM-SIO2R has reset but the data logger has not. It does, however, mean that the SDM-SIO2R does not start up in its lowest power mode. To place the SDM-SIO2R into its lowest power mode, you will need to run the `SerialClose()` instruction.

7.3 Schematic

Figure 7-1 (p. 36) shows the internal configuration of the SDM-SIO2R when configured in RS-485 or RS-422 full-duplex mode. This shows the internal resistors to aid users trying to test system interconnections and drive levels.

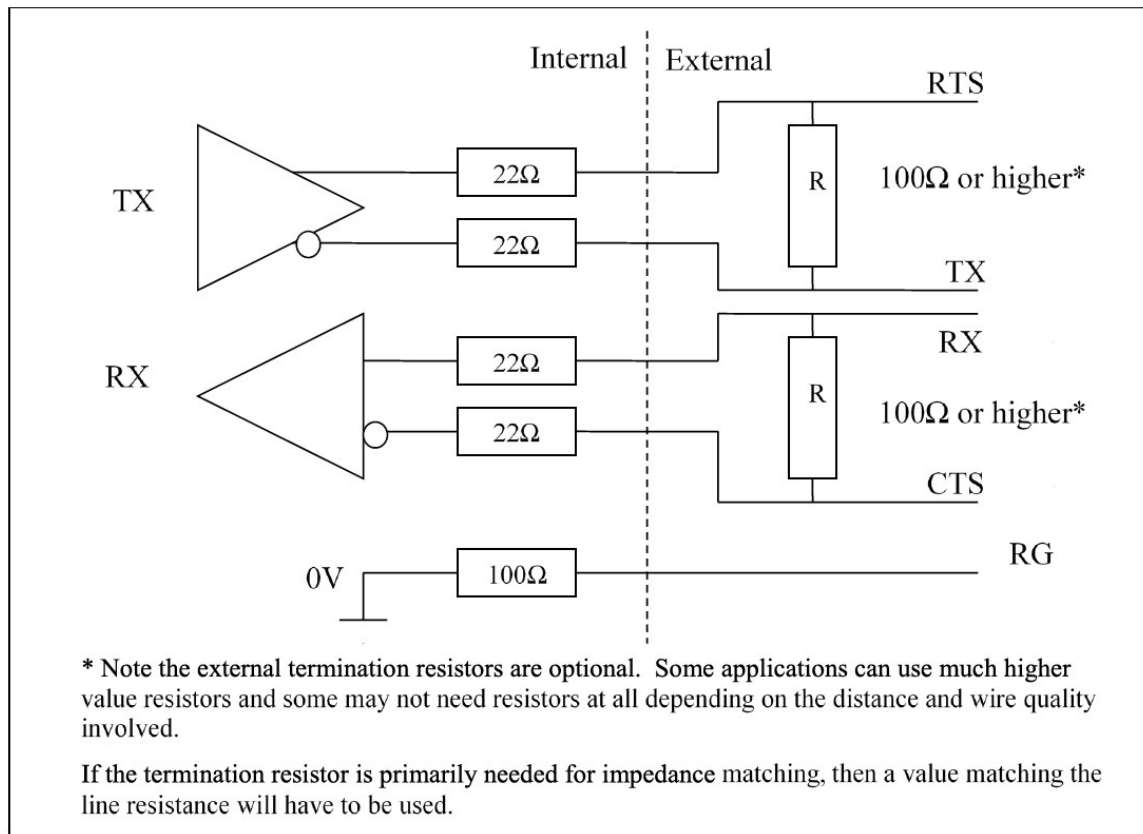

Figure 7-1. RS-485 internal circuit diagram

RG is for connecting the screen/ground of the data lines when in RS-485 mode; there is a 1 W 100 Ω resistor in series designed to limit any currents that may be induced due to a difference in ground potentials between the sensor and the SDM-SIO2R.

8. Troubleshooting and maintenance

8.1 Troubleshooting

If correctly connected, the SDM-SIO2R normally operates seamlessly. However, there are some common issues people encounter during setup or sometimes after a period of operation.

During the setup phase, either no data or corrupt data may be received by the data logger. When receiving data, the character “?” will be returned in place of the expected data whenever a parity, framing, or overrun error is detected. These errors are only flagged for RS-232/RS-485/RS-422 data coming into the SDM-SIO2R.

These types of errors are usually caused by a connection issue or sometimes a mismatch of the interface type, baud rate, or data format (parity, etc.).

Some confusion can be caused in debugging such problems because it is possible for the communication to partly work even with such mismatches, for instance:

- Mismatched parity settings will often show many valid characters interspersed with invalid characters or “?” which the SDM-SIO2R will store if there are parity errors.
- Incorrect connections resulting in inverted signals can also result in some valid characters being received, but usually with no normal data.
- An RS-485 receiver can often read data transmitted at RS-232 levels, although the reverse will not work.

Where you see some serial activity which is invalid, check the documentation and configuration of both the device the SDM-SIO2R is connected to and the data logger. Also, check the wiring carefully.

In the case of RS-485/RS-422, there is also a big risk of confusion being caused by there being several different ways of labeling the transmit and receive lines. Some devices may even have reversed meaning for some lines—for example, A and B are sometimes used and transposed. Generally, for these lines it is safe to try swapping them around if there is doubt as to whether the same terminology is being used.

If you are sure the configuration and wiring of the data logger and serial device is correct, it is possible to check what the data logger thinks it is transmitting and the data it is receiving by

connecting to the data logger with a computer and entering the terminal mode. You can then use the “W” command to “sniff” data passing to and fro through any serial port including SDM-SIO2R ports. The data can be displayed in ASCII or binary (HEX) modes. This is a powerful tool for checking programming errors and the response of remote devices. See the data logger manual for more information on terminal mode.

Either during setup or at some point later, it is possible that erratic communication errors may be seen. The normal cause of this will be noise pickup, especially for long cable runs. The likelihood of such errors can be reduced by using screened cable, making sure there is a ground connection between the two systems, and installing termination resistors for RS-485/RS-422 links. It is worth noting that textbooks often say termination resistors are only needed for long cables at very high baud rates, which is true when considering noise caused by reflections. However, even a single termination resistor at one end of the link can suppress induced noise caused by pickup from other sources such as nearby mains cables. As a general rule, if you have a noise issue, it is worth trying to add a cheap 100-120 Ω resistor across RS-485 lines.

8.2 Maintenance

There are no user serviceable parts. Changes or modifications to this device not expressly approved by Campbell Scientific may result in damaged equipment or loss of data.

No regular maintenance is needed for the SDM-SIO2R; however, occasionally operating system upgrades are released to add enhanced features or to correct bugs. The operating system is normally published in the Support section of our website at www.campbellsci.com .

8.2.1 Upgrading the operating system

In the unlikely event that the operating system of the SDM-SIO2R needs to be upgraded, this can be achieved by connecting it to a computer and using the Campbell Scientific **Device Configuration Utility** to load the operating system. (This program can be downloaded free of charge from www.campbellsci.com/downloads .

The SDM-SIO2R needs a reliable source of 12V power connected in the standard way. It also requires a cable similar to that shown in [Connecting a 9-way socket to the SDM-SIO2R for RS-232 devices](#) (p. 25) to connect to an RS-232 port on the computer. However, there is no requirement to connect any handshaking lines.

Start **Device Configuration Utility** and select the SDM-SIO2R device. (The SDM-SIO2R device may not be available in older versions of the software. New versions can be downloaded from the Campbell Scientific website at www.campbellsci.com .) Follow the instructions for that device to load a new operating system. At the end of the process, a success message will be shown if

successful. During the loading of the operating system, do not disturb or disconnect power to the SDM-SIO2R, otherwise it may need to be returned to the factory for repair.

When following this process with the SDM-SIO2R, it is necessary to run this process two times, connecting to each serial port in turn. This is because each serial port has its own microprocessor with each holding their own copy of the operating system.

8.2.2 Operating system signature errors

The operating system is stored in flash memory. When a new version is loaded, a checksum signature is automatically created the first time its run. This checksum is stored in memory. This signature value can be read back using the data logger and compared to the signature supplied with the operating system version that was just loaded (contact Campbell Scientific if you need to do this).

If the SDM-SIO2R is not operational or is exhibiting random faults, the flash memory may be corrupted. This is a very unlikely event due to the robust nature of the flash device used. The unit automatically checks the flash memory against its signature upon power up. If an error is found, it will send out the string **sig error:XXXX:YYYY** when an error is detected, where XXXX is the signature as it's being read and YYYY is the stored signature.

The error string is sent out via the RS-232 port automatically and will also be returned to the data logger the next time any attempt is made to read information from the sensor. The message will be output at the default baud rate of 9600 bps, 8-bits, 1 stop, and no parity.

If this error is seen, contact Campbell Scientific to obtain a copy of the latest operating system and load it into the SDM-SIO2R using the preceding procedure. If this does not correct the fault, the unit may be faulty and will need to be returned to the factory for repair.

8.2.3 Checking the operating system version and signature

It is not possible to check the current operating system version using *Device Configuration Utility* as the SDM-SIO2R is designed as a transparent RS-232 device. Instead, the operating system version can be checked by loading a program into the data logger to which it is attached. The following program shows use of the **SDMGeneric()** instruction to ask the SDM-SIO2R with a specific address what the operating system version is (Ver_value) and the signature of the operating system (Sig_value).

CRBasic Example 1: Checking the operating system version and signature

```
' -----  
' Simple OS version and OS sig check for the SDM-SIO2R  
' -----  
  
'Variables and constants for the version number and signature checking  
Public Ver_Value As String * 25 'Holds version as text string  
Public Sig_Value As String * 4 'Holds SIG of OS as four byte HEX string  
Public Sig_Value_Dec 'Holds sig as a decimal number  
  
'Change this address to match the SDM-SIO2R SDM address.  
Const SDM_Address=0  
  
Dim Src As String * 1  
Const cmd = 5 'constant cmd = 0..7  
Const bytes_out = 1 'constant number of bytes out  
Const bytes_val = 1 'constant bytes per value (1,2,4)  
Const big_endian = 1 'constant 1 (big endian) or 0 (little endian)  
Const delay_usec = -0 'constant delay between outgoing bytes (negative means  
'delay also for incoming bytes)  
Const Ver_values_in = 20 'constant number of values to receive  
Const Sig_values_in = 4 'constant number of values to receive  
  
SequentialMode  
  
BeginProg  
  SDMSpeed (30) 'Fix the speed  
  Ver_Value = ""  
  Sig_Value = ""  
  
  Scan(1,Sec,0,0)  
    'Use the generic SDM instruction to get extra info from the SDM-SIO2R  
    'Ask for the operating system version  
    Src = CHR(1)  
    SDMGeneric(Ver_Value,SDM_Address,cmd,bytes_out,Src,Ver_values_in,bytes_val, _  
    big_endian,delay_usec)  
    'Read signature  
    Src = CHR(2)  
    SDMGeneric(Sig_Value,SDM_Address,cmd,bytes_out,Src,Sig_values_in, _  
    bytes_val,big_endian,delay_usec)  
    Sig_Value_Dec = HexToDec (Sig_Value) 'Convert sig to decimal too.  
  Next Scan  
  
EndProg
```

Appendix A. Using the handshaking lines for general input/output

This appendix describes how to use the CTS and RTS lines for input and output ports.

The I/O pins (CTS and RTS) can be read or set by the user as required, allowing unique protocols to be created, or they can simply be used as flags or enable lines.

If the user enables automatic handshaking as discussed in [Using RTS/CTS and automatic handshaking](#) (p. 34), these pins cannot be accessed.

A.1 Input pin (CTS)

The state of the input line can be read by using the special `SDMGeneric()` instruction in CRBasic.

Bit 16 of a value returned to the data logger using the `SDMGeneric()` instruction reports whether the input is logic high or low. The following example shows how to call the instruction with the required parameters.

CRBasic Example 2: Detecting the state of the input line

```
'CR1000 example program showing how to detect the state of the input line on an
'SDM-SIO2R using the SDMGeneric instruction
Public sio1response As Long, Inputstate As Boolean
Const addr = 0 'constant sdm address CHANGE with SDM-SIO2R address
Const cmd = 1 'constant, command 1 returns the input state in bit 16
Const bytes_out = 0 'constant number of bytes out - none sent
Const bytes_val = 2 'two bytes returned
Const big_endian = 1 '1=(big endian)
Const delay_usec = -0 'delay between outgoing bytes (negative means delay also
'for incoming bytes)

Const Values_in = 1
'Main Program
BeginProg
  Scan (1,Sec,0,0) 'Or whatever scan rate is being used
  'Use the SDMGeneric instruction to send command 0x01 which returns the input
  'line state as bit 16
  SDMGeneric(sio1response,addr,cmd,bytes_out,"",Values_in,bytes_val, _
  big_endian,delay_usec)
  'bit 16 set for input line high or low so check the value and set a Boolean
  'var TRUE or FALSE accordingly
  Inputstate = sio1response AND &H8000
NextScan
EndProg
```

The input line can accept 0 and 5V logic inputs OR –12 and +12V RS-232 level inputs. The following table shows a breakdown of the different input voltages allowed and the state of the input line flag.

Voltage on the input line	State of bit 16
+12V	1
–12V	0
5V	1
0V	0

A.2 Output pin (RTS)

To set the output pin (RTS) you must use the [SerialOutBlock\(\)](#) instruction.

The spare I/O lines are RS-232 lines, NOT logic lines. This means that the output line voltage is –12V and +12V (approximately), not 0 and 5V.

The following examples show you how to set the output pin using the `SerialOutBlock()` instruction.

CRBasic example for setting the output pin

```
SerialOutBlock(32, 1, 0) 'This will set the spare output pin high  
SerialOutBlock(32, 0, 0) 'This will set the spare output pin low
```

The preceding two example lines of code will set the output pin on the SDM-SIO2R high then low respectively on the SDM-SIO2R device set to address 0 on its rotary switch.

Any value greater than 1 will set the output pin high, but usually the number 1 is used, as this will improve the readability of the code.

Value of SerialOutBlock SerialExpression variable	Voltage on the output line
1	+12V ¹
0	-12V ¹
¹ Approximate voltage; do not drive relays or high current loads directly from this pin.	

Appendix B. Example data logger programs

The first two examples show how to write programs in CRBasic that send and receive data using the SDM-SIO2R. These programs are not extensive and are fundamentally no different to those written for use when reading data from a standard data logger serial port.

The program code is the same for all data loggers that support the SDM-SIO2R.

The exact program to be used will vary with the serial device being used. Unfortunately, the number of possible variations of reading different sensors is almost infinite. If you are struggling to write code, please contact Campbell Scientific who may already have experience with the sensor and may be able to offer advice on how to deal with it.

A third example shows how to control the switched relay power using the [SDMSIO2R\(\)](#) instruction.

B.1 Example using RS-232 mode

CRBasic Example 3: RS-232 mode example

```
'-----  
' Example use of the SDM-SIO2R.  
' This example shows how to open a serial port using an SDM-SIO2R.  
' A prompt is sent from the data logger to the sensor and it then waits for a  
' response before reading the data.  
' The data logger then retrieves the data and places it into a string  
'-----  
  
Public ReturnedData as string * 100 'string where the data from the data logger  
                                     'is stored  
  
BeginProg  
  
Const SensorPort = 32 'Declare the serial port the sensor is set to  
'The sensors address switch should be set to position 0  
SDMSpeed (30) 'Optionally set the SDMSpeed - not normally needed  
  
Scan(1000,mSec,0,0)  
  
    'Open serial port to RS-232 mode, 115200bps, 8-bit data, 1 stop bit,  
    'and no parity  
    SerialOpen (SensorPort,115200,3,100,10000) 'open the serial port to  
                                                'the sensor  
  
    'Request data' will need to be replaced with the correct command for  
    'your sensor  
    'In this example we wait for the response 'Start' for up to 1 second  
    'before continuing  
    SerialOut (SensorPort,"Request data","Start",1,100) 'Send data to the sensor  
  
        SerialIn (ReturnedData,SensorPort,100,0,100) 'Get data from the sensor  
  
    SerialClose (SensorPort) 'Close the serial port to the sensor  
    'this places the SDM-SIO2R into its lowest power mode  
  
    'Now there would be code to read the data out of the ReturnedData string and  
    'either store it as strings or convert the string into number(s).  
  
Next Scan  
EndProg
```

B.2 Example using RS-485 mode

CRBasic Example 4: RS-485 mode example

```
'-----  
'This example shows how to open the RS-485 serial port using an SDM-SIO2R.  
'Data is sent from the data logger to the sensor. The program then sits in  
'a loop until the SDM-SIO2R reports data is available.  
'The data logger then retrieves the data and places it into a string  
'The returned string is then converted to a float and an offset is applied.  
'-----  
  
Public ChkValReturned 'value returned by the SerialInChk function  
Public AvailableData 'amount of data in the SDM-SIO2Rs buffer at present  
Public ReturnedData As String * 100 'string where the data from the data logger  
                                     'is stored  
Public ConvertedValue As Float 'floating point value returned by sensor  
SequentialMode  
BeginProg  
  Const SensorPort = 32 'Declare the serial port the sensor is set to  
  'The sensors address switch should be set to position 0  
  SDMSpeed (30) 'Optionally set the SDMSpeed, not normally needed  
  Scan(1000,mSec,0,0)  
  'Open serial port to RS-485 mode, 115200bps, 8-bit data, 1 stop bit, and  
  'no parity  
  'note that the 'SerialOpenFormat' parameter is 19 for RS-485 mode  
  SerialOpen (SensorPort,115200,19,100,10000) 'open the serial port to  
                                               'the sensor  
  
  'Request data' will need to be replaced with the correct command for  
  'your sensor  
  SerialOut (SensorPort,"Request data","",0,10) 'Send data to the sensor  
  'wait for the sensor to respond using a loop this time - this may be useful  
  'if there is not a predictable response from the sensor.  
Do  
  ChkValReturned = SerialInChk (SensorPort) 'Get available data  
  AvailableData = ChkValReturned AND 4095 'mask off the input pin flag  
                                           '(bit 16)  
  
  Loop Until AvailableData <> 0 'wait until data is available  
  SerialIn (ReturnedData,SensorPort,100,0,100) 'Get data from the sensor  
  'Convert string to float  
  ConvertedValue = ReturnedData  
  'add an offset to the returned floating point value  
  ConvertedValue = ConvertedValue + 100  
  SerialClose (SensorPort) 'Close the serial port to the sensor  
  'this places the SDM-SIO2R into its lowest power mode  
Next Scan  
EndProg
```

B.3 Example using switched relay power

CRBasic Example 5: Switched relay mode example

'CR1000X Program showing how to use SDM-SIO2R. This program will transmit/receive serial data and

'This program will also control the switched relay power using SDM-Generic

SequentialMode 'Sequential Mode allows for the program to have SDM-Generic command within Conditional Statements

```
Public dest As Long ' variable holding incoming bytes from SDM device
Const SDM_addr0 = 0 ' sdm address of device communicating with. valid addresses 0-14
Const SDM_addr1 = 1 ' sdm address of device communicating with. valid addresses 0-14
Const cmd_byte = 7 ' setup byte sent to SDM device
Public hexVar0 As Long ' variable holding values to be sent to SDM device
Public hexVar1 As Long ' variable holding values to be sent to SDM device
Const num_vals_out = 1 ' number of values to be sent to SDM device. number of bytes out - none sent
Const source As String = "" ' variable holding values to be sent to SDM device
Const num_vals_in = 0 ' number of values expected to be received back from SDM device.
Const bytes_per_value = 1 ' number of bytes for each value sent to or received from SDM device. one bytes returned
Const big_endian = 1 ' order of bytes sent or received, 0 = little endian, 1 = big endian
Const delay_byte = -0 ' delay in microseconds between sending bytes (negative means delay for incoming bytes from SDM device)

Public Sensor_1_In As String * 50
Public Sensor_2_In As String * 50
Public Sensor_1_Out As String * 50 = "Get Awpag Data "
Public Sensor_2_Out As String * 50 = "Get Temp Data "

Public counter

BeginProg
  SerialOpen (32,9600,0,0,50)
  SerialOpen (33,9600,0,0,50)

  Scan (1000,mSec,0,0)

  SerialOut (32,Sensor_1_Out + counter,"",0,0) ' Send query for data
  SerialOut (33,Sensor_2_Out + counter,"",0,0)

  SerialIn (Sensor_1_In,32,10,0,50) ' receive data back
  SerialIn (Sensor_2_In,33,10,0,50)
```

CRBasic Example 5: Switched relay mode example

```
' Below If Statement just cycles the different relays to test and do a fun LED
display
' Send 2 digit hex value through SDMGeneric
' Left Digit controls V+, Right Digit controls 12V
' Sending a 1 turns LED/Relay On, Sending a 2 Turns LED/Relay off, Sending a 0
means not to change LED/Relay value
If counter = 1 Then
  hexVar0 = &H22 'Sensor1: 12V OFF, Sensor1: V+ OFF
  hexVar1 = &H22 'Sensor2: 12V OFF, Sensor2: V+ OFF
  SDMGeneric(dest, SDM_addr0, cmd_byte, num_vals_out, hexVar0, num_vals_in,
  bytes_per_value, big_endian, delay_byte)
  SDMGeneric(dest, SDM_addr1, cmd_byte, num_vals_out, hexVar1, num_vals_in,
  bytes_per_value, big_endian, delay_byte)
ElseIf counter = 2 Then
  hexVar0 = &H01 'Sensor1: 12V ON
  SDMGeneric(dest, SDM_addr0, cmd_byte, num_vals_out, hexVar0, num_vals_in,
  bytes_per_value, big_endian, delay_byte)
ElseIf counter = 3 Then
  hexVar0 = &H10 'Sensor1: V+ ON
  SDMGeneric(dest, SDM_addr0, cmd_byte, num_vals_out, hexVar0, num_vals_in,
  bytes_per_value, big_endian, delay_byte)
ElseIf counter = 4 Then
  hexVar1 = &H01 'Sensor2: 12V ON
  SDMGeneric(dest, SDM_addr1, cmd_byte, num_vals_out, hexVar1, num_vals_in,
  bytes_per_value, big_endian, delay_byte)
ElseIf counter = 5 Then
  hexVar1 = &H10 'Sensor2: V+ ON
  SDMGeneric(dest, SDM_addr1, cmd_byte, num_vals_out, hexVar1, num_vals_in,
  bytes_per_value, big_endian, delay_byte)
ElseIf counter = 6 Then
  hexVar1 = &H20 'Sensor2: V+ OFF
  SDMGeneric(dest, SDM_addr1, cmd_byte, num_vals_out, hexVar1, num_vals_in,
  bytes_per_value, big_endian, delay_byte)
ElseIf counter = 7 Then
  hexVar1 = &H02 'Sensor2: 12V OFF
  SDMGeneric(dest, SDM_addr1, cmd_byte, num_vals_out, hexVar1, num_vals_in,
  bytes_per_value, big_endian, delay_byte)
ElseIf counter = 8 Then
  hexVar0 = &H20 'Sensor1: V+ OFF
  SDMGeneric(dest, SDM_addr0, cmd_byte, num_vals_out, hexVar0, num_vals_in,
  bytes_per_value, big_endian, delay_byte)
ElseIf counter = 9 Then
  hexVar0 = &H02 'Sensor1: 12V OFF
  SDMGeneric(dest, SDM_addr0, cmd_byte, num_vals_out, hexVar0, num_vals_in,
  bytes_per_value, big_endian, delay_byte)
ElseIf counter = 10 Then
  hexVar0 = &H11 'Sensor1: 12V ON, Sensor1: V+ ON
  hexVar1 = &H11 'Sensor2: 12V ON, Sensor2: V+ ON
```

CRBasic Example 5: Switched relay mode example

```
SDMGeneric(dest, SDM_addr0, cmd_byte, num_vals_out, hexVar0, num_vals_in,  
bytes_per_value, big_endian, delay_byte)  
SDMGeneric(dest, SDM_addr1, cmd_byte, num_vals_out, hexVar1, num_vals_in,  
bytes_per_value, big_endian, delay_byte)  
counter = 0  
EndIf  
counter += 1  
NextScan  
EndProg
```

B.4 Example using SDM-SIO2R with CS120A

In this example program, a SDM-SIO2R will read a visibility measurement from the CS120A. If the SIO2R does not get data from the CS120A three consecutive times, the SIO2R will turn off power to the sensor for 10 seconds and then turn power to the sensor back on and try communicating with it again. A downloadable version of the program is available at <https://www.campbellsci.com/downloads/sdm-sio2r-cs120a-example-program>

Limited warranty

Covered equipment is warranted/guaranteed against defects in materials and workmanship under normal use and service for the period listed on your sales invoice or the product order information web page. The covered period begins on the date of shipment unless otherwise specified. For a repair to be covered under warranty, the following criteria must be met:

1. There must be a defect in materials or workmanship that affects form, fit, or function of the device.
2. The defect cannot be the result of misuse.
3. The defect must have occurred within a specified period of time; and
4. The determination must be made by a qualified technician at a Campbell Scientific Service Center/ repair facility.

The following is not covered:

1. Equipment which has been modified or altered in any way without the written permission of Campbell Scientific.
2. Batteries; and
3. Any equipment which has been subjected to misuse, neglect, acts of God or damage in transit.

Campbell Scientific regional offices handle repairs for customers within their territories. Please see the back page of the manual for a list of [regional offices](#) or visit www.campbellsci.com/contact  to determine which Campbell Scientific office serves your country. For directions on how to return equipment, see [Assistance](#).

Other manufacturer's products, that are resold by Campbell Scientific, are warranted only to the limits extended by the original manufacturer.

CAMPBELL SCIENTIFIC EXPRESSLY DISCLAIMS AND EXCLUDES ANY IMPLIED WARRANTIES OF MERCHANTABILITY OR FITNESS FOR A PARTICULAR PURPOSE. Campbell Scientific hereby disclaims, to the fullest extent allowed by applicable law, any and all warranties and conditions with respect to the products, whether express, implied, or statutory, other than those expressly provided herein.

Campbell Scientific will, as a default, return warranted equipment by surface carrier prepaid. However, the method of return shipment is at Campbell Scientific's sole discretion. Campbell Scientific will not reimburse the claimant for costs incurred in removing and/or reinstalling equipment. This warranty and the Company's obligation thereunder is in lieu of all other

warranties, expressed or implied, including those of suitability and fitness for a particular purpose. Campbell Scientific is not liable for consequential damage.

In the event of any conflict or inconsistency between the provisions of this Warranty and the provisions of Campbell Scientific's Terms, the provisions of Campbell Scientific's Terms shall prevail. Furthermore, Campbell Scientific's Terms are hereby incorporated by reference into this Warranty. To view Terms and conditions that apply to Campbell Scientific, Logan, UT, USA, see [Terms and Conditions](#) . To view terms and conditions that apply to Campbell Scientific offices outside of the United States, contact the [regional office](#) that serves your country.

Assistance

Products may not be returned without prior authorization. Please inform us before returning equipment and obtain a **return material authorization (RMA) number** whether the repair is under warranty/guarantee or not. See [Limited warranty](#) for information on covered equipment.

Campbell Scientific regional offices handle repairs for customers within their territories. Please see the back page of the manual for a list of [regional offices](#) or visit www.campbellsci.com/contact  to determine which Campbell Scientific office serves your country.

When returning equipment, a RMA number must be clearly marked on the outside of the package. Please state the faults as clearly as possible. Quotations for repairs can be given on request.

It is the policy of Campbell Scientific to protect the health of its employees and provide a safe working environment. In support of this policy, when equipment is returned to Campbell Scientific, Logan, UT, USA, it is mandatory that a "[Declaration of Hazardous Material and Decontamination](#)" form be received before the return can be processed. If the form is not received within 5 working days of product receipt or is incomplete, the product will be returned to the customer at the customer's expense. For details on decontamination standards specific to your country, please reach out to your [regional Campbell Scientific](#) office.

NOTE:

All goods that cross trade boundaries may be subject to some form of fee (customs clearance, duties or import tax). Also, some regional offices require a purchase order upfront if a product is out of the warranty period. Please contact your [regional Campbell Scientific](#) office for details.

Safety

DANGER — MANY HAZARDS ARE ASSOCIATED WITH INSTALLING, USING, MAINTAINING, AND WORKING ON OR AROUND TRIPODS, TOWERS, AND ANY ATTACHMENTS TO TRIPODS AND TOWERS SUCH AS SENSORS, CROSSARMS, ENCLOSURES, ANTENNAS, ETC. FAILURE TO PROPERLY AND COMPLETELY ASSEMBLE, INSTALL, OPERATE, USE, AND MAINTAIN TRIPODS, TOWERS, AND ATTACHMENTS, AND FAILURE TO HEED WARNINGS, INCREASES THE RISK OF DEATH, ACCIDENT, SERIOUS INJURY, PROPERTY DAMAGE, AND PRODUCT FAILURE. TAKE ALL REASONABLE PRECAUTIONS TO AVOID THESE HAZARDS. CHECK WITH YOUR ORGANIZATION'S SAFETY COORDINATOR (OR POLICY) FOR PROCEDURES AND REQUIRED PROTECTIVE EQUIPMENT PRIOR TO PERFORMING ANY WORK.

Use tripods, towers, and attachments to tripods and towers only for purposes for which they are designed. Do not exceed design limits. Be familiar and comply with all instructions provided in product manuals. Manuals are available at www.campbellsci.com You are responsible for conformance with governing codes and regulations, including safety regulations, and the integrity and location of structures or land to which towers, tripods, and any attachments are attached. Installation sites should be evaluated and approved by a qualified engineer. If questions or concerns arise regarding installation, use, or maintenance of tripods, towers, attachments, or electrical connections, consult with a licensed and qualified engineer or electrician.

General

- Protect from over-voltage.
- Protect electrical equipment from water.
- Protect from electrostatic discharge (ESD).
- Protect from lightning.
- Prior to performing site or installation work, obtain required approvals and permits. Comply with all governing structure-height regulations, such as those of the FAA in the USA.
- Use only qualified personnel for installation, use, and maintenance of tripods and towers, and any attachments to tripods and towers. The use of licensed and qualified contractors is highly recommended.
- Read all applicable instructions carefully and understand procedures thoroughly before beginning work.
- Wear a hardhat and eye protection, and take other appropriate safety precautions while working on or around tripods and towers.
- Do not climb tripods or towers at any time, and prohibit climbing by other persons. Take reasonable precautions to secure tripod and tower sites from trespassers.
- Use only manufacturer recommended parts, materials, and tools.

Utility and Electrical

- You can be killed or sustain serious bodily injury if the tripod, tower, or attachments you are installing, constructing, using, or maintaining, or a tool, stake, or anchor, come in contact with overhead or underground utility lines.
- Maintain a distance of at least one-and-one-half times structure height, 6 meters (20 feet), or the distance required by applicable law, whichever is greater, between overhead utility lines and the structure (tripod, tower, attachments, or tools).
- Prior to performing site or installation work, inform all utility companies and have all underground utilities marked.
- Comply with all electrical codes. Electrical equipment and related grounding devices should be installed by a licensed and qualified electrician.
- Only use power sources approved for use in the country of installation to power Campbell Scientific devices.

Elevated Work and Weather

- Exercise extreme caution when performing elevated work.
- Use appropriate equipment and safety practices.
- During installation and maintenance, keep tower and tripod sites clear of un-trained or non-essential personnel. Take precautions to prevent elevated tools and objects from dropping.
- Do not perform any work in inclement weather, including wind, rain, snow, lightning, etc.

Internal Battery

- Be aware of fire, explosion, and severe-burn hazards.
- Misuse or improper installation of the internal lithium battery can cause severe injury.

- Do not recharge, disassemble, heat above 100 °C (212 °F), solder directly to the cell, incinerate, or expose contents to water. Dispose of spent batteries properly.

Use and disposal of batteries

- Where batteries need to be transported to the installation site, ensure they are packed to prevent the battery terminals shorting which could cause a fire or explosion. Especially in the case of lithium batteries, ensure they are packed and transported in a way that complies with local shipping regulations and the safety requirements of the carriers involved.
- When installing the batteries follow the installation instructions very carefully. This is to avoid risk of damage to the equipment caused by installing the wrong type of battery or reverse connections.
- When disposing of used batteries, it is still important to avoid the risk of shorting. Do not dispose of the batteries in a fire as there is risk of explosion and leakage of harmful chemicals into the environment. Batteries should be disposed of at registered recycling facilities.

Avoiding unnecessary exposure to radio transmitter radiation

- Where the equipment includes a radio transmitter, precautions should be taken to avoid unnecessary exposure to radiation from the antenna. The degree of caution required varies with the power of the transmitter, but as a rule it is best to avoid getting closer to the antenna than 20 cm (8 inches) when the antenna is active. In particular keep your head away from the antenna. For higher power radios (in excess of 1 W ERP) turn the radio off when servicing the system, unless the antenna is installed away from the station, e.g. it is mounted above the system on an arm or pole.

Maintenance

- Periodically (at least yearly) check for wear and damage, including corrosion, stress cracks, frayed cables, loose cable clamps, cable tightness, etc. and take necessary corrective actions.
- Periodically (at least yearly) check electrical ground connections.

WHILE EVERY ATTEMPT IS MADE TO EMBODY THE HIGHEST DEGREE OF SAFETY IN ALL CAMPBELL SCIENTIFIC PRODUCTS, THE CUSTOMER ASSUMES ALL RISK FROM ANY INJURY RESULTING FROM IMPROPER INSTALLATION, USE, OR MAINTENANCE OF TRIPODS, TOWERS, OR ATTACHMENTS TO TRIPODS AND TOWERS SUCH AS SENSORS, CROSSARMS, ENCLOSURES, ANTENNAS, ETC.

Global Sales and Support Network

A worldwide network to help meet your needs



Campbell Scientific Regional Offices

Australia

Location: Garbutt, QLD Australia
Phone: 61.7.4401.7700
Email: info@campbellsci.com.au
Website: www.campbellsci.com.au

Brazil

Location: São Paulo, SP Brazil
Phone: 11.3732.3399
Email: vendas@campbellsci.com.br
Website: www.campbellsci.com.br

Canada

Location: Edmonton, AB Canada
Phone: 780.454.2505
Email: dataloggers@campbellsci.ca
Website: www.campbellsci.ca

China

Location: Beijing, P. R. China
Phone: 86.10.6561.0080
Email: info@campbellsci.com.cn
Website: www.campbellsci.com.cn

Costa Rica

Location: San Pedro, Costa Rica
Phone: 506.2280.1564
Email: info@campbellsci.cc
Website: www.campbellsci.cc

France

Location: Montrouge, France
Phone: 0033.0.1.56.45.15.20
Email: info@campbellsci.fr
Website: www.campbellsci.fr

Germany

Location: Bremen, Germany
Phone: 49.0.421.460974.0
Email: info@campbellsci.de
Website: www.campbellsci.de

India

Location: New Delhi, DL India
Phone: 91.11.46500481.482
Email: info@campbellsci.in
Website: www.campbellsci.in

South Africa

Location: Stellenbosch, South Africa
Phone: 27.21.8809960
Email: sales@campbellsci.co.za
Website: www.campbellsci.co.za

Spain

Location: Barcelona, Spain
Phone: 34.93.2323938
Email: info@campbellsci.es
Website: www.campbellsci.es

Thailand

Location: Bangkok, Thailand
Phone: 66.2.719.3399
Email: info@campbellsci.asia
Website: www.campbellsci.asia

UK

Location: Shephed, Loughborough, UK
Phone: 44.0.1509.601141
Email: sales@campbellsci.co.uk
Website: www.campbellsci.co.uk

USA

Location: Logan, UT USA
Phone: 435.227.9120
Email: info@campbellsci.com
Website: www.campbellsci.com